

# Crestron CNPI-48

## 48-Button Control Panel Interface

---

## Operations Guide



This document was prepared and written by the Technical Documentation department at:



Crestron Electronics, Inc.

15 Volvo Drive

Rockleigh, NJ 07647

1-888-CRESTRON

# Contents

<b>48-Button Control Panel Interface: CNPI-48</b>	<b>1</b>
Introduction .....	1
Features and Functions .....	1
Specifications .....	2
Physical Description .....	3
Industry Compliance .....	5
Setup .....	6
Network Wiring .....	6
Identity Code .....	6
Supplied Hardware .....	7
Installation .....	7
Hardware Hookup .....	7
Programming Software .....	10
Earliest Version Software Requirements for the PC .....	10
Programming with SIMPL Windows .....	10
Operation .....	12
Problem Solving .....	13
Troubleshooting .....	13
Check Network Wiring .....	13
Further Inquiries .....	14
Future Updates .....	14
Return and Warranty Policies .....	15
Merchandise Returns / Repair Service .....	15
CRESTRON Limited Warranty .....	15



# 48-Button Control Panel Interface: CNPI-48

---

## Introduction

Currently there are two CNPI-48 configurations available. A configuration is defined by either an "L" or "I" placed after the "CNPI-48" nomenclature. The CNPI-48L drives LED indicators and the CNPI-48I drives incandescent indicators. Except where noted, CNPI-48 is used to describe both configurations.

To determine the unit's configuration, remove the front cover of the CNPI-48 which is held in place by six hex screws. Towards the bottom of the circuit board there are six IC sockets labeled **RP15**, **RP16**, **RP17**, **RP18**, **RP19**, and **RP20**. If the sockets are populated by resistor packs (orange in color at the time of printing this document), the unit is a CNPI-48L. If these sockets are populated with wire jumpers in place, the unit is a CNPI-48I.

## Features and Functions

- 48 digital inputs to accept contact closures from third-party switches
- 48 incandescent lamp (CNPI-48I) output drivers or 48 LED drivers (CNPI-48L)
- Two bargraph outputs

The CNPI-48 allows third-party custom control panels to be interfaced to the Cresnet<sup>®</sup> system in the same manner as a Crestron<sup>®</sup> keypad. It provides 48 digital inputs to accept contact closures from third-party switches, 48 incandescent lamp output drivers (for the CNPI-48I), 48 LED output drivers (for the CNPI-48L), and two bargraph outputs.

## Specifications

Specifications for the CNPI-48 are listed in the following table.

### *CNPI-48 Specifications*

SPECIFICATION	DETAILS
Power Requirements Cresnet Power Usage (CNPI-48I)	40 Watts (1.67 Amps @ 24 Volts DC) average; 50 Watts maximum; (Approx. 2 Watts + 1 Watt per incandescent lamp)
(CNPI-48L)	6.8 Watts (0.29 Amps @ 24 Volts DC) average; (Approx. 2 Watts + 0.1 Watt per LED)
Default Net ID	11
Minimum 2-Series Control System Update File <sup>1,2</sup>	Version 1.0 or later
Environmental	
Temperature	41° to 104°F (5° to 40°C)
Humidity	10% to 90% RH (non-condensing)
Enclosure	Surface mount "sandwich" PCB assembly with black metal top panel
Dimensions	
Height	5.80 in (14.73 cm)
Width	7.60 in (19.30 cm)
Depth	1.10 in (2.79 cm)
Weight	1.11 lbs (0.5 kg)

1. The latest software versions can be obtained from the Crestron website. Refer to the NOTE following these footnotes.
2. Crestron 2-Series control systems include the AV2 and PRO2. Consult the latest Crestron Product Catalog for a complete list of 2-Series control systems.

**NOTE:** Crestron software and any files on the website are for authorized Crestron dealers and Crestron Authorized Independent Programmers (CAIP) only. New users may be required to register to obtain access to certain areas of the site (including the FTP site).

### Physical Description

This section provides information on the connections, controls and indicators available on your CNPI-48.

#### *CNPI-48 Physical View*



#### *CNPI-48 Overall Dimensions*

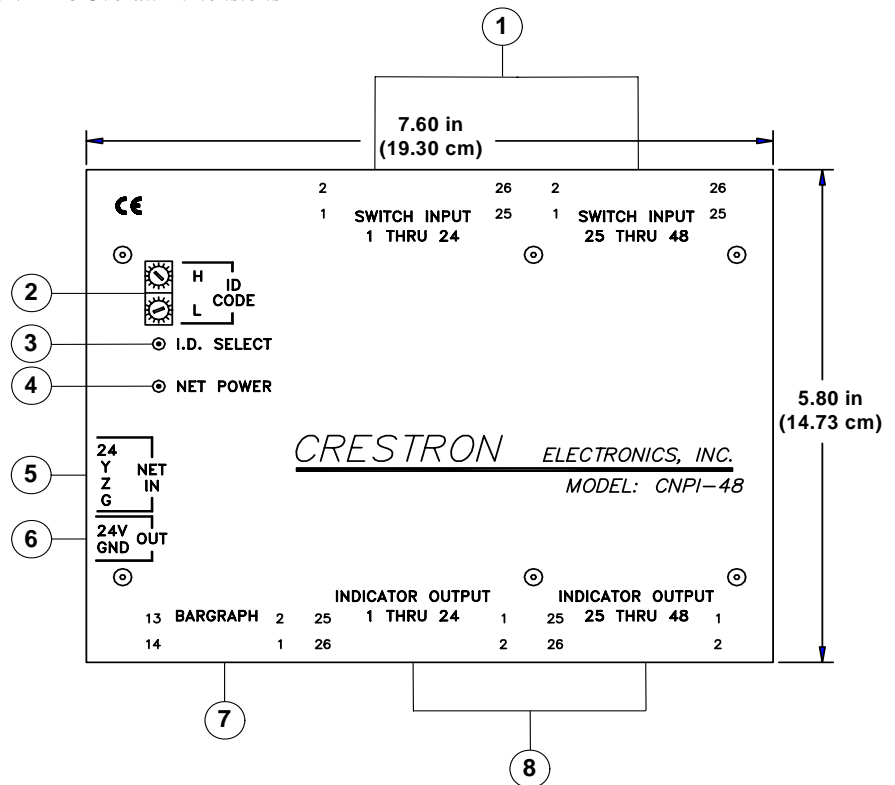

*Connectors, Controls & Indicators*

#	CONNECTORS <sup>1</sup> , CONTROLS & INDICATORS	DESCRIPTION
1	SWITCH INPUT	(2) 26-pin PC-mounted connectors; (48) Digital inputs referenced to system ground; Connects to blunt-cut ribbon cables (included)
2	ID CODE	(2) Rotary DIP Switches; Used for setting the unit's Net ID
3	I.D. SELECT	Red LED, indicates communication with the Cresnet control network
4	NET POWER	Green LED, indicates 24 Volts DC power supplied from Cresnet control network
5	NET IN	(1) 4-pin 5mm detachable terminal block; Cresnet slave port, connects to Cresnet control network
6	OUT	(1) 2-pin 5mm detachable terminal block; Paralleled with 24 and G of the "NET IN" connector; Maximum Load: 0.5 Amps
7	BARGRAPH	(1) 14-pin PC-mounted connector; (2) Bargraph outputs; Connect to third-party bargraph displays (not included)
8	INDICATOR OUTPUT <sup>2</sup>	(2) 26-pin PC-mounted connectors; (48) incandescent lamp drivers referenced to +24V (CNPI-48I); (48) LED drivers referenced to +5V (CNPI-48L); Connects to blunt-cut ribbon cables (included); Output Current (per output): 200 mA maximum; Output Current (per group): 1 Amp maximum per each group of 8 outputs; Output Current (total): 2 Amps maximum

1. Interface connectors for **NET IN**, and **OUT** ports are provided with the unit.
2. The CNPI-48L's internal 5 Volt DC supply is limited to 800mA total output. An external power supply is required for larger loads.



## Industry Compliance

As of the date of manufacture, the CNPI-48 has been tested and found to comply with specifications for CE marking and standards per EMC and Radiocommunications Compliance Labelling.



---

**NOTE:** This device complies with part 15 of the FCC rules. Operation is subject to the following two conditions: (1) this device may not cause harmful interference and (2) this device must accept any interference received, including interference that may cause undesired operation.

This equipment has been tested and found to comply with the limits for a Class B digital device, pursuant to part 15 of the FCC Rules. These limits are designed to provide reasonable protection against harmful interference in a residential installation. This equipment generates, uses and can radiate radio frequency energy and if not installed and used in accordance with the instructions, may cause harmful interference to radio communications. However, there is no guarantee that interference will not occur in a particular installation. If this equipment does cause harmful interference to radio or television reception, which can be determined by turning the equipment off and on, the user is encouraged to try to correct the interference by one or more of the following measures:

- Reorient or relocate the receiving antenna.
  - Increase the separation between the equipment and receiver.
  - Connect the equipment into an outlet on a circuit different from that to which the receiver is connected.
  - Consult the dealer or an experienced radio/TV technician for help.
-

---

## Setup

### Network Wiring

When wiring the network, consider the following:

- Use Crestron Certified Wire.
- Use Crestron power supplies for Crestron equipment.
- Provide sufficient power to the system.

---

**CAUTION:** Insufficient power can lead to unpredictable results or damage to the equipment. Please use the Crestron Power Calculator to help calculate how much power is needed for the system (<http://www.crestron.com/calculators>).

---

- For larger networks, use a Cresnet Hub/Repeater (CNXHUB) to maintain signal quality.

For more details, refer to “Check Network Wiring” on page 13.

### Identity Code

The Net ID of the CNPI-48 has been factory set to **11**. The Net IDs of multiple CNPI-48 devices in the same system must be unique. To set the Net ID, make sure power to the unit is disconnected and complete the following steps.

1. Locate the two miniature rotary switches labeled **HI** and **LO** on the front face. The switches are located in the upper left corner of the unit. The upper-most rotary switch (**HI**) represents the most-significant digit or number of the Net ID and the lower rotary switch (**LO**) represent the least-significant digit or number of the Net ID. Each 16-position rotary hexadecimal switch can be set to a value ranging between 0 and F.
2. Use a small screwdriver and rotate the arrow in the center of the rotary switch marked **HI** to the position of the most-significant digit or letter of the unit's Net ID.
3. Use a small screwdriver and rotate the arrow in the center of the rotary switch marked **LO** to the position of the least-significant digit or letter of the unit's Net ID.

---

**NOTE:** It is safe to adjust the Net ID of the CNPI-48 while unit is connected to the network. However, if the Net ID is changed while the unit is powered, the new Net ID will not be recognized until the power is removed and reapplied.

---

## Supplied Hardware

The hardware supplied with the CNPI-48 is listed in the following table.

### *Supplied Hardware for the CNPI-48*

DESCRIPTION	PART NUMBER	QUANTITY
Cable Assembly, Indicator to Switch	4500699	4
Connector, Plug, 2-pin, SKT, Single Row	2003582	1
Connector, Plug, 4-pin, SKT, Single Row	2003584	1

## Installation

The CNPI-48 can be placed on a horizontal or slightly sloped surface using the Dual Lock fasteners found on the back face of the unit.

## Hardware Hookup

Complete the following steps in the order specified to ensure proper connections for the unit. Refer to the diagram below and the next page for typical hook-up diagrams for the CNPI-48.

---

**NOTE:** When the CNPI-48 is not connected to the Cresnet control network and the Net ID is greater than 80 (hexadecimal), the CNPI-48 provides local feedback (i.e., a closure on input 1 causes output 1 to provide a closure).

---

### *Hardware Connections for CNPI-48*

TYPICAL SWITCH CONNECTIONS

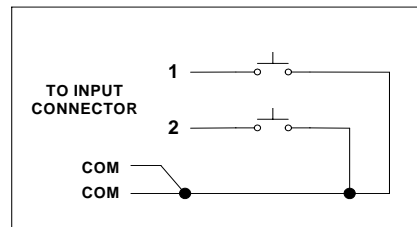

TYPICAL LED CONNECTIONS

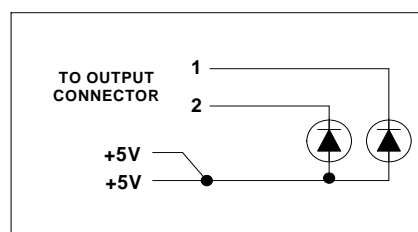

TYPICAL INCANDESCENT CONNECTIONS

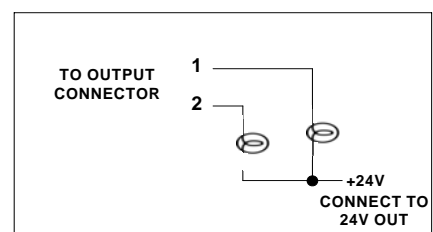

*(Continued on following page)*

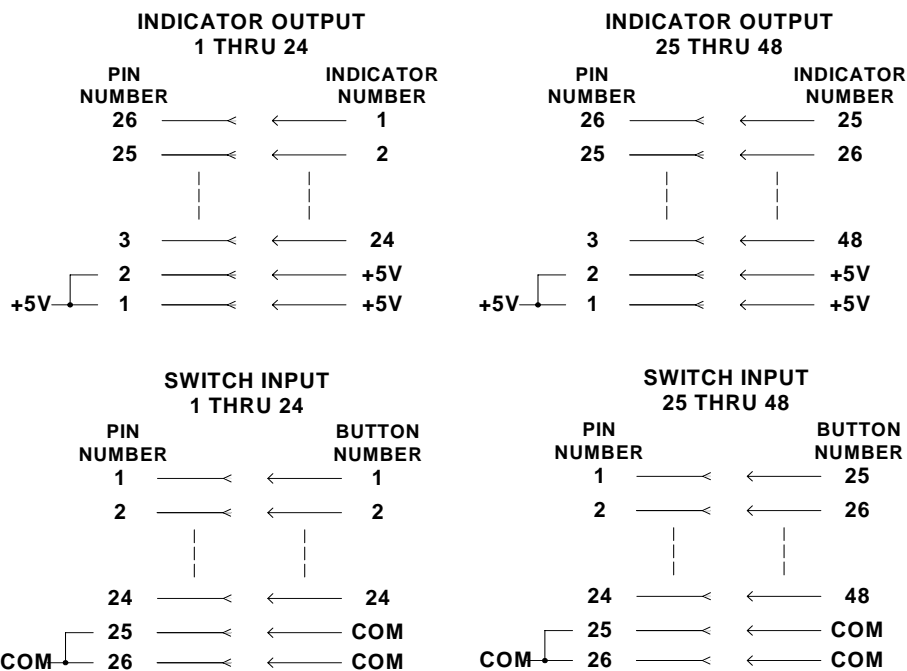
*Hardware Connections for CNPI-48 (Continued)*

1. Disconnect Cresnet power supply and any external power supply.
2. Wire the CNPI-48 4-pin connector, labeled **NET IN**, to the Cresnet control network. Network termination points are available at the control system power supply. Network units may also be daisy-chained together.

---

**NOTE:** Output #1, pin #26 maps to input #1, pin #1.

**NOTE:** When connecting the flat cable to the CNPI-48, insert the cable so that the brown wire at the fringe of the ribbon connect to the pin #1 on the unit's 26-pin connector. The blue wire at the opposite fringe of the ribbon connects to the pin #26.

---

3. Use the supplied 26-position flat cables and wire the custom control panel pushbuttons or switches to the two CNPI-48 26-pin male connectors, labeled **SWITCH INPUT 1 THRU 24** and **SWITCH INPUT 25 THRU 48**.
4. Use the supplied 26-position flat cables and wire the LED or incandescent indicator on the custom panel to the two CNPI-48 26-pin male connectors, labeled **INDICATOR OUTPUT 1 THRU 24** and **INDICATOR OUTPUT 25 THRU 48**.
5. Connect power from the CNPI-48 2-pin connector, labeled **OUT**, to any device that requires it.
6. **OPTIONAL BARGRAPH INTERFACE:**  
All CNPI-48s have a 14-pin bargraph interface, labeled **BARGRAPH**, which can be connected to a third-party bargraph display. Refer to the pinout diagram on the next page.
7. Reconnect and apply Cresnet power supply. Observe illumination of the red LED marked **ID. SELECT** and green LED marked **NET POWER** on the board.

*CNPI-48 Pinout Diagram*

<b>BARGRAPH</b>	
<b>PIN NUMBER</b>	<b>BARGRAPH FUNCTION</b>
14	————<    <———— <b>GND</b>
13	————<    <———— <b>GND</b>
12	————<    <———— <b>+5V</b>
11	————<    <———— <b>+5V</b>
10	————<    <———— <b>DATA OUT</b>
9	————<    <———— <b>CLOCK</b>
8	————<    <———— <b>DATA IN</b>
7	————<    <———— <b>INPUT STROBE</b>
6	————<    <———— <b>OUTPUT STROBE</b>
5	————<    <———— <b>OUTPUT ENABLE</b>
4	————<    <———— <b>KEY</b>
3	————<    <———— <b>+24V</b>
2	————<    <———— <b>NO CONNECT</b>
1	————<    <———— <b>NO CONNECT</b>

## Programming Software

### Have a question or comment about Crestron software?

Answers to frequently asked questions (FAQs) can be viewed in the Online Help section of the Crestron website. To post a question or view questions you have submitted to Crestron's True Blue Support, log in at <http://support.crestron.com>. First-time users will need to establish a user account.

### Earliest Version Software Requirements for the PC

**NOTE:** Crestron recommends that you use the latest software to take advantage of the most recently released features. The latest software is available from the Crestron website.

Crestron has developed an assortment of Windows®-based software tools to develop a Cresnet system. The following are the minimum recommended software versions for the PC:

#### Software

TASK	REQUIRED SOFTWARE VERSION
Program control system to operate CNPI-48.	SIMPL Windows version 1.0 or later with SIMPL+ Cross Compiler version 1.0 or later and Library update 1.0 or later. Also requires Crestron Database version 1.0 or later.

### Programming with SIMPL Windows

SIMPL Windows is Crestron's premier software for programming Crestron control systems. It is organized into two separate but equally important "Managers".

#### Configuration Manager

Configuration Manager is the view where programmers "build" a Crestron control system by selecting hardware from the *Device Library*.

- To incorporate the CNPI-48 into the system, drag the CNPI-48 from the Wired Keypads folder of the *Device Library* and drop it in the *System Views*.

#### Locating the CNPI-48 in the Device Library

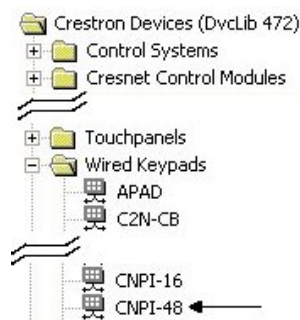

- The system tree of the control system displays the device in the appropriate slot with a default Net ID as shown in the illustration on the next page.

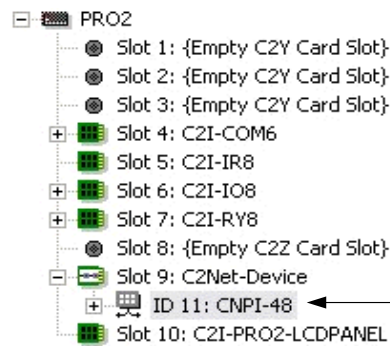
*C2Net Device, Slot 9*

- Additional CNPI-48 devices are assigned different Net ID numbers as they are added.
- If necessary, double click a device to open the “Device Settings” window and change the Net ID as shown in the following figure.

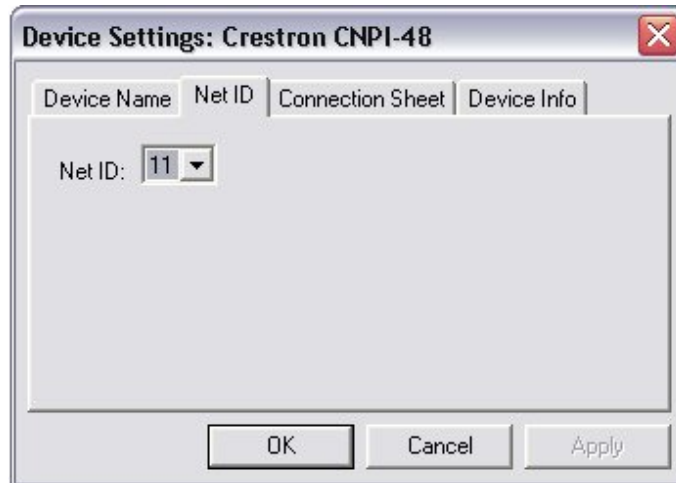
*“CNPI-48 Device Settings” Window*

- The ID code specified in the SIMPL Windows program must match the Net ID of each unit. Refer to “Identity Code” on page 6.

**Program Manager**

Program Manager is the view where programmers “program” a Crestron control system by assigning signals to symbols.

The symbol can be viewed by double clicking on the icon or dragging it into *Detail View*. Each signal in the symbol is described in the SIMPL Windows help file (**F1**).

## Operation

The custom control panel can consist of pushbuttons or switches, which provide closures to the CNPI-48 via its two 26-pin input connectors. The CNPI-48 translates these closures into inputs to the Cresnet system via the Cresnet control network.

Any LED or incandescent indicators used in the custom control panel are treated as network feedback outputs and driven by the CNPI-48 via its two 26-pin output connectors. All CNPI-48s have a 14-pin bargraph interface which can be connected to a third-party bargraph display (not included).



## Problem Solving

### Troubleshooting

The following table provides corrective action for possible trouble situations. If further assistance is required, please contact a Crestron customer service representative.

#### CNPI-48 Troubleshooting

TROUBLE	POSSIBLE CAUSE(S)	CORRECTIVE ACTION
Green <b>NET POWER</b> LED is not illuminated.	CNPI-48 is not receiving network power.	Confirm power is supplied to the network (i.e., check if power supply is functioning and wired properly).
Red <b>I.D. SELECT</b> LED does not illuminate.	Net ID setting was changed after CNPI-48 powered up.	Power down CNPI-48. Power up to reset Net ID.
	CNPI-48 Net ID is not set to match the Net ID of the SIMPL Program.	Verify that the Net ID for the CNPI-48 is properly set to match the SIMPL program.

### Check Network Wiring

#### Use the Right Wire

In order to ensure optimum performance over the full range of your installation topology, Crestron Certified Wire and only Crestron Certified Wire may be used. Failure to do so may incur additional charges if support is required to identify performance deficiencies because of using improper wire.

#### Calculate Power

**CAUTION:** Use only Crestron power supplies for Crestron equipment. Failure to do so could cause equipment damage or void the Crestron warranty.

**CAUTION:** Provide sufficient power to the system. Insufficient power can lead to unpredictable results or damage to the equipment. Please use the Crestron Power Calculator to help calculate how much power is needed for the system (<http://www.crestron.com/calculators>).

When calculating the length of wire for a particular Cresnet run, the wire gauge and the Cresnet power usage of each network unit to be connected must be taken into consideration. Use Crestron Certified Wire only. If Cresnet units are to be daisy-chained on the run, the Cresnet power usage of each network unit to be daisy-chained must be added together to determine the Cresnet power usage of the entire chain. If the unit is home-run from a Crestron system power supply network port, the Cresnet power usage of that unit is the Cresnet power usage of the entire run. The wire gauge and the Cresnet power usage of the run should be used in the following equation to calculate the cable length value on the equation's left side.

#### Cable Length Equation

$$L < \frac{40,000}{R \times P}$$

Where: L = Length of run (or chain) in feet  
 R = 6 Ohms (Crestron Certified Wire: 18 AWG (0.75 MM<sup>2</sup>))  
 or 1.6 Ohms (Cresnet HP: 12 AWG (4 MM<sup>2</sup>))  
 P = Cresnet power usage of entire run (or chain)

Make sure the cable length value is less than the value calculated on the right side of the equation. For example, a Cresnet run using 18 AWG Crestron Certified Wire and drawing 20 watts should not have a length of run more than 333 feet. If Cresnet HP is used for the same run, its length could extend to 1250 feet.

---

**NOTE:** All Crestron certified Cresnet wiring must consist of two twisted pairs. One twisted pair is the +24V conductor and the GND conductor and the other twisted pair is the Y conductor and the Z conductor.

---

#### *Strip and Tin Wire*

When daisy-chaining Cresnet units, strip the ends of the wires carefully to avoid nicking the conductors. Twist together the ends of the wires that share a pin on the network connector and tin the twisted connection. Apply solder only to the ends of the twisted wires. Avoid tinning too far up the wires or the end becomes brittle. Insert the tinned connection into the Cresnet connector and tighten the retaining screw. Repeat the procedure for the other three conductors.

#### *Add Hubs*

For larger networks (i.e., greater than 28 network devices), it may become necessary to add a Cresnet Hub/Repeater (CNXHUB) to maintain signal quality throughout the network. Also, for networks with lengthy cable runs it may be necessary to add a Hub/Repeater after only 20 devices.

## Further Inquiries

If you cannot locate specific information or have questions after reviewing this guide, please take advantage of Crestron's award winning customer service team by calling the Crestron corporate headquarters at 1-888-CRESTRON [1-888-273-7876]. For assistance in your local time zone, refer to the Crestron website (<http://www.crestron.com/offices>) for a listing of Crestron worldwide offices.

You can also log onto the online help section of the Crestron website (<http://www.crestron.com/onlinehelp>) to ask questions about Crestron products. First-time users will need to establish a user account to fully benefit from all available features.

## Future Updates

As Crestron improves functions, adds new features and extends the capabilities of the CNPI-48, additional information may be made available as manual updates. These updates are solely electronic and serve as intermediary supplements prior to the release of a complete technical documentation revision.

Check the Crestron website periodically for manual update availability and its relevance. Updates are identified as an "Addendum" in the Download column.

---

## Return and Warranty Policies

### Merchandise Returns / Repair Service

1. No merchandise may be returned for credit, exchange or service without prior authorization from CRESTRON. To obtain warranty service for CRESTRON products, contact an authorized CRESTRON dealer. Only authorized CRESTRON dealers may contact the factory and request an RMA (Return Merchandise Authorization) number. Enclose a note specifying the nature of the problem, name and phone number of contact person, RMA number and return address.
2. Products may be returned for credit, exchange or service with a CRESTRON Return Merchandise Authorization (RMA) number. Authorized returns must be shipped freight prepaid to CRESTRON, 6 Volvo Drive, Rockleigh, N.J. or its authorized subsidiaries, with RMA number clearly marked on the outside of all cartons. Shipments arriving freight collect or without an RMA number shall be subject to refusal. CRESTRON reserves the right in its sole and absolute discretion to charge a 15% restocking fee plus shipping costs on any products returned with an RMA.
3. Return freight charges following repair of items under warranty shall be paid by CRESTRON, shipping by standard ground carrier. In the event repairs are found to be non-warranty, return freight costs shall be paid by the purchaser.

### CRESTRON Limited Warranty

CRESTRON ELECTRONICS, Inc. warrants its products to be free from manufacturing defects in materials and workmanship under normal use for a period of three (3) years from the date of purchase from CRESTRON, with the following exceptions: disk drives and any other moving or rotating mechanical parts, pan/tilt heads and power supplies are covered for a period of one (1) year; touchscreen display and overlay components are covered for 90 days; batteries and incandescent lamps are not covered.

This warranty extends to products purchased directly from CRESTRON or an authorized CRESTRON dealer. Purchasers should inquire of the dealer regarding the nature and extent of the dealer's warranty, if any.

CRESTRON shall not be liable to honor the terms of this warranty if the product has been used in any application other than that for which it was intended or if it has been subjected to misuse, accidental damage, modification or improper installation procedures. Furthermore, this warranty does not cover any product that has had the serial number altered, defaced or removed.

This warranty shall be the sole and exclusive remedy to the original purchaser. In no event shall CRESTRON be liable for incidental or consequential damages of any kind (property or economic damages inclusive) arising from the sale or use of this equipment. CRESTRON is not liable for any claim made by a third party or made by the purchaser for a third party.

CRESTRON shall, at its option, repair or replace any product found defective, without charge for parts or labor. Repaired or replaced equipment and parts supplied under this warranty shall be covered only by the unexpired portion of the warranty.

Except as expressly set forth in this warranty, CRESTRON makes no other warranties, expressed or implied, nor authorizes any other party to offer any warranty, including any implied warranties of merchantability or fitness for a particular purpose. Any implied warranties that may be imposed by law are limited to the terms of this limited warranty. This warranty statement supersedes all previous warranties.

#### Trademark Information

*All brand names, product names and trademarks are the sole property of their respective owners. Windows is a registered trademark of Microsoft Corporation. Windows95/98/Me/XP/Vista and WindowsNT/2000 are trademarks of Microsoft Corporation.*



**Crestron Electronics, Inc.**  
15 Volvo Drive Rockleigh, NJ 07647  
Tel: 888.CRESTRON  
Fax: 201.767.7576  
[www.crestron.com](http://www.crestron.com)

---

**Operations Guide – DOC. 8016C**  
**(2002136)**  
**05.07**  
Specifications subject to  
change without notice.