

Crestron **CEN-RGBHVHB**  
High-Bandwidth RGB Matrix Switcher

---

Operations Guide



## Important Safety Instructions

- Read these instructions.
- Keep these instructions.
- Heed all warnings.
- Follow all instructions.
- Do not use this apparatus near water.
- Clean only with dry cloth.
- Do not block any ventilation openings. Install in accordance with the manufacturer's instructions.
- Do not install near any heat sources such as radiators, heat registers, stoves, or other apparatus (including amplifiers) that produce heat.
- Do not defeat the safety purpose of the polarized or grounding-type plug. A polarized plug has two blades with one wider than the other. A grounding-type plug has two blades and a third grounding prong. The wide blade or the third prong are provided for your safety. If the provided plug does not fit into your outlet, consult an electrician for replacement of the obsolete outlet.
- Protect the power cord from being walked on or pinched particularly at plugs, convenience receptacles, and the point where they exit from the apparatus.
- Only use attachments/accessories specified by the manufacturer.
- Use only with the cart, stand, tripod, bracket or table specified by the manufacturer or sold with the apparatus. When a cart is used, use caution when moving the cart/apparatus combination to avoid injury from tip-over. 
- Unplug this apparatus during lightning storms or when unused for long periods of time.
- Refer all servicing to qualified service personnel. Servicing is required when the apparatus has been damaged in any way, such as power-supply cord or plug is damaged, liquid has been spilled or objects have fallen into the apparatus, the apparatus has been exposed to rain or moisture, does not operate normally, or has been dropped.
- Disconnect power prior to connecting or disconnecting equipment.
- Do not install in direct sunlight.
- The apparatus must be installed in a way that the power cord can be removed either from the wall outlet or from the device itself in order to disconnect the mains power.
- Prevent foreign objects from entering the device.

### WARNING:

---

TO REDUCE THE RISK OF FIRE OR ELECTRIC SHOCK, DO NOT EXPOSE THIS APPARATUS TO RAIN OR MOISTURE. THE APPARATUS SHALL NOT BE EXPOSED TO DRIPPING OR SPLASHING. OBJECTS FILLED WITH LIQUIDS, SUCH AS VASES, SHOULD NOT BE PLACED ON THE APPARATUS.

---

### WARNING:

---

TO PREVENT ELECTRIC SHOCK, DO NOT REMOVE COVER. THERE ARE NO USER SERVICEABLE PARTS INSIDE. ONLY QUALIFIED SERVICE PERSONNEL SHOULD PERFORM SERVICE.

---

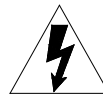

The lightning flash with arrowhead symbol, within an equilateral triangle, is intended to alert the user to the presence of uninsulated “dangerous voltage” within the product’s enclosure that may be of sufficient magnitude to constitute a risk of electric shock to persons.

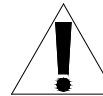

The exclamation point within an equilateral triangle is intended to alert the user to the presence of important operating and maintenance (servicing) instructions in the literature accompanying the appliance.

### WARNING:

---

THIS IS AN APPARATUS WITH CLASS I CONSTRUCTION. IT SHALL BE CONNECTED TO AN ELECTRICAL OUTLET WITH AN EARTHING GROUND TERMINAL.

---

### IMPORTANT:

---

This device can be used with Class 2 output wiring.

---

## Regulatory Compliance

This product is Listed to applicable UL Standards and requirements by Underwriters Laboratories Inc.



As of the date of manufacture, the CEN-RGBHVHB has been tested and found to comply with specifications for CE marking and standards per EMC and Radiocommunications Compliance Labelling.



---

## Federal Communications Commission (FCC) Compliance Statement

**CAUTION:** Changes or modifications not expressly approved by the manufacturer responsible for compliance could void the user's authority to operate the equipment.

**NOTE:** This equipment has been tested and found to comply with the limits for a Class B digital device, pursuant to part 15 of the FCC Rules. These limits are designed to provide reasonable protection against harmful interference in a residential installation. This equipment generates, uses and can radiate radio frequency energy and, if not installed and used in accordance with the instructions, may cause harmful interference to radio communications. However, there is no guarantee that interference will not occur in a particular installation. If this equipment does cause harmful interference to radio or television reception, which can be determined by turning the equipment off and on, the user is encouraged to try to correct the interference by one or more of the following measures:

- Reorient or relocate the receiving antenna
- Increase the separation between the equipment and receiver
- Connect the equipment into an outlet on a circuit different from that to which the receiver is connected
- Consult the dealer or an experienced radio/TV technician for help

---

## Industry Canada (IC) Compliance Statement

CAN ICES-3(B)/NMB-3(B)

---

The specific patents that cover Crestron products are listed at [patents.crestron.com](http://patents.crestron.com).

Crestron, the Crestron logo, Cresnet, Crestron e-Control, Crestron Studio, Crestron Toolbox, e-Control, Fusion RV, and SystemBuilder are either trademarks or registered trademarks of Crestron Electronics, Inc. in the United States and/or other countries. Other trademarks, registered trademarks, and trade names may be used in this document to refer to either the entities claiming the marks and names or their products. Crestron disclaims any proprietary interest in the marks and names of others. Crestron disclaims any proprietary interest in the marks and names of others. *Crestron is not responsible for errors in typography or photography.*

This document was written by the Technical Publications department at Crestron.  
©2013 Crestron Electronics, Inc.



# Contents

<b>High-Bandwidth RGB Matrix Switcher: CEN-RGBHVHB</b>	<b>1</b>
Introduction .....	1
Features and Functions .....	1
Specifications .....	3
Physical Description .....	6
Setup .....	13
Network Wiring .....	13
Identity Code .....	13
Installation .....	14
Hardware Hookup .....	16
Uploading and Upgrading .....	18
Establishing Communication .....	18
Programs and Firmware .....	19
Program Checks .....	20
Operation .....	21
Menu Structure .....	21
Setup and Informational Screens .....	21
Routing Signals .....	41
Sync Mode .....	42
Paging Mode .....	42
Problem Solving .....	43
Troubleshooting .....	43
Check Network Wiring .....	43
Reference Documents .....	44
Further Inquiries .....	44
Future Updates .....	44
Return and Warranty Policies .....	45
Merchandise Returns / Repair Service .....	45
Crestron Limited Warranty .....	45



# High-Bandwidth RGB Matrix Switcher: CEN-RGBHVHB

---

## Introduction

Crestron® High-Bandwidth RGB Matrix Switchers deliver extreme performance for the most demanding presentation environments. With class-leading 800 MHz bandwidth, low crosstalk, and super wide response, the CEN-RGBHVHB8X4, CEN-RGBHVHB8X8, CEN-RGBHVHB12X4, and CEN-RGBHVHB12X8 (hereinafter collectively referred to as CEN-RGBHVHB) easily surpass any requirement for high-performance, high-resolution analog video and computer signal routing. Factor in their enhanced audio DSP, very low power consumption, and native Crestron system integration and any of these is a solid winner for all analog video and audio signal routing applications.

## Features and Functions

- Ultra high bandwidth matrix switcher
  - 8 x 4 in CEN-RGBHVHB8X4
  - 8 x 8 in CEN-RGBHVHB8X8
  - 12 x 4 in CEN-RGBHVHB12X4
  - 12 x 8 in CEN-RGBHVHB12X8
- 800 MHz video bandwidth (-3 dB)
- Incredibly wide response and low crosstalk
- Stereo audio signal routing with breakaway
- Audio DSP with volume, tone, and graphic EQ
- *Paging* mode with automatic ducking
- Professional balanced audio inputs and outputs
- Audio input level compensation
- Video input sync detection
- Video-follow-sync switching technology
- Adjustable video and audio blanking
- Selectable input sync impedance on all inputs
- LCD front panel for easy setup and standalone operation
- Crestron system integration via Cresnet® or Ethernet
- Very low power consumption and a quiet fanless design
- 3-space rack mountable

### **800 MHz Bandwidth Matrix Router**

The CEN-RGBHVHB is capable of routing up to eight (CEN-RGBHVHB8X4, CEN-RGBHVHB8X8) or 12 (CEN-RGBHVHB12X4, CEN-RGBHVHB12X8) computer or video sources to up to four (CEN-RGBHVHB8X4, CEN-RGBHVHB12X4) or eight (CEN-RGBHVHB8X8, CEN-RGBHVHB12X8) display devices. Its five matrix levels accommodate any combination of analog RGBHV, HD/component, S-video and composite signals. Ultra high bandwidth and wide response ensure optimum performance for every signal as part of any AV system. Sync impedances for each input are selectable from the front panel or software to accommodate both short and long cable runs.

### **Glitch-free Switching**

Video-follow-sync switching ensures a smooth transition when selecting between non-synchronous sources. Adjustable blanking allows each display device time to lock to the new sync signal before displaying the video image whenever a new source is selected.

### **Sync Detection**

Sync detection on each H and V input measures the sync rates of every RGBHV source and allows their values to be viewed on the front panel display, on the control system touch screen, or through Crestron's Fusion RV<sup>®</sup> software.\*

### **Audio Routing & DSP**

Professional audio signal processing affords enhanced, high-performance audio routing and control, potentially eliminating the need for additional audio components. Each stereo output features real time controllable volume, bass, treble, and mute controls, plus 5-band EQ with customizable presets. Programmable input level compensation helps ensure compatibility with a wide range of pro and semi-pro sources. Automatic blanking achieves a pop-free transition when switching between sources, while audio breakaway capability allows the routing of audio signals to follow video or be switched independently. The entire audio signal path has been designed from the ground up to deliver ultra quiet, distortion-free sound quality — whether feeding sensitive amplifiers, assistive listening devices, or recording and broadcast equipment.

### **Paging Mode**

Built-in page override functionality simplifies system design, employing automatic mixing and ducking for a single audio paging source. When set to *Paging* mode, an audio signal at the last input channel is automatically distributed to every output while the signals currently routed to each output are attenuated or “ducked” to allow the paging signal to be heard. The sensitivity and ducking amount are fully adjustable for smooth paging behavior and a natural transition back to the previous audio state.

### **Full-featured Front Panel**

The CEN-RGBHVHB is fully operable out-of-the-box for use as a standalone switcher. Featuring an informative LCD display, quick-adjust knob, and quick access buttons, the front panel supports essential switcher operation without requiring a computer or control system. Advanced setup is available through Crestron Toolbox™ software. All signal routing, input impedances, and audio settings are stored in non-volatile memory onboard the switcher.

\* Sync detection reports discrete H and V signals only.



Customizable label strips are provided on the front panel for clear designation of its inputs and outputs using Crestron Engraver software or standard 3/8” tape labels. Names may also be entered through software to appear on the LCD display during operation. For security, front panel controls can be password protected or locked out.

**Crestron System Integration**

Via Cresnet or high speed Ethernet, Crestron switchers offer the ultimate in control system integration. Every function is accessible for custom programming through Crestron Studio™, SIMPL Windows or SystemBuilder™ software without deciphering cryptic protocols. Up to 10 routing presets can be saved onboard for instant recall. Integration with a Crestron control system also provides the gateway to Fusion RV and e-Control® remote control and management solutions.

**Specifications**

Specifications for the CEN-RGBHVHB are listed in the following table.

*CEN-RGBHVHB Specifications*

SPECIFICATION	DETAILS
Video/RGB Switcher  Signal Types  Video/HD Formats RGB Formats Horizontal Frequency: Vertical Frequency: Gain Bandwidth Blanking Time Sync Rise/Fall Time:	CEN-RGBHVHB8X4: 8 x 4 (x 5) CEN-RGBHVHB8X8: 8 x 8 (x 5) CEN-RGBHVHB12X4: 12 x 4 (x 5) CEN-RGBHVHB12X8: 12 x 8 (x 5) matrix video-follow-sync switching, adjustable blanking, sync detection, sync regeneration, front panel selectable sync input termination  RGB and composite, S-video or component video (does not transcode)  NTSC or PAL, HD up to 1080i/1080p RGBHV, RGBS <sup>1</sup> , RGsB <sup>1</sup> or YUV <sup>1</sup> 10 kHz to 200 kHz 20 Hz to 200 Hz 0 dB (75 Ω terminated) 800 MHz (-3 dB) Adjustable 0 to 10 seconds, 0.5 second steps 2 ns maximum
Audio Switcher	Stereo matrix switching CEN-RGBHVHB8X4: 8 x 4 CEN-RGBHVHB8X8: 8 x 8 CEN-RGBHVHB12X4: 12 x 4 CEN-RGBHVHB12X8: 12 x 8  Adjustable blanking; audio breakaway; input gain compensation; 4-channel or 8-channel <sup>2</sup> stereo DSP with 5-band graphic EQ, volume, bass, treble, and mute control; <i>Paging</i> mode (signal at last input momentarily mixes with or overrides the current selected input at every output with adjustable sensitivity and ducking behavior)

*(Continued on following page)*

*CEN-RGBHVHB Specifications (Continued)*

SPECIFICATION	DETAILS
Audio (Continued)	
Signal Types	Balanced and unbalanced stereo analog line level
• Typical of Stereo Inputs:	
Analog to Digital Conversion	24-bit 48 kHz
Input Compensation	±10 dB per input
• Last input only, Paging Mode:	
Mix Input Level	0 to 100%
Sensing Threshold	-80 to 0 dB
Sensing Attack Time	1 to 250 ms
Sensing Hold Time:	1 to 2000 ms
Ducking Depth	0 to 80 dB attenuation
Ducking Release Time	1 to 1000 ms per dB of recovery
• Typical of Stereo Outputs:	
Digital-to-Analog Conversion	24-bit 48 kHz
Frequency Response	20 Hz to 20 kHz ±0.5 dB
THD + Noise	0.005%
S/N Ratio	>104 dB @ full output, A-weighted
Stereo Separation	>104 dB
Output Channel Separation	>100 dB
Blanking Time	Adjustable 0 to 10 seconds, 0.5 second steps
Output Volume Level Control	-80.0 to +20.0 dB, adjustable from 0% to 100% plus mute
Bass Control	±15 dB
Treble Control	±15 dB
EQ Mode	5-band graphic EQ
GEQ Center Frequencies	63, 200, 550, 2 kHz, 12 kHz
GEQ Gain	±12 dB per band
Communications	
Ethernet	For control and console, 10/100 Mbps, auto-switching, auto-negotiating, auto-discovery, full/half duplex, TCP/IP, UDP/IP CIP, DHCP
Cresnet	For control and console, Cresnet slave
USB	USB client for computer console
Power Requirements	
Main Power	1 amp maximum @ 100-240 volts ac, 50/60 Hz
Power Consumption	30 watts maximum
Cresnet Power Usage	None
Default Net ID	33

*(Continued on following page)*

*CEN-RGBHVHB Specifications (Continued)*

SPECIFICATION	DETAILS
Environmental Temperature Humidity Heat Dissipation	32° to 104° F (0° to 40° C) 10% to 90% RH (non-condensing) 102 Btu/h maximum
Enclosure Chassis Faceplate Mounting	Metal, matte black finish, convection cooled, vented sides Metal, matte black finish, with polycarbonate label overlay Freestanding or 3U 19-inch rack mountable (adhesive feet and rack ears included)
Dimensions Height Width Depth	5.20 in (132 mm) without feet 17.03 in (433 mm); 19.00 in (483 mm) with ears 13.13 in (334 mm)
Weight	14.5 lb (6.6 kg)

1. Sync detection reports discrete H and V signals only.
2. 4-channel on CEN-RGBHVHB8X4 and CEN-RGBHVHB12X4; 8-channel on CEN-RGBHVHB8X8 and CEN-RGBHVHB12X8.

### Physical Description

This section provides information on the connections, controls and indicators available on the CEN-RGBHVHB.

*CEN-RGBHVHB8X4 Front View*



*CEN-RGBHVHB8X4 Rear View*

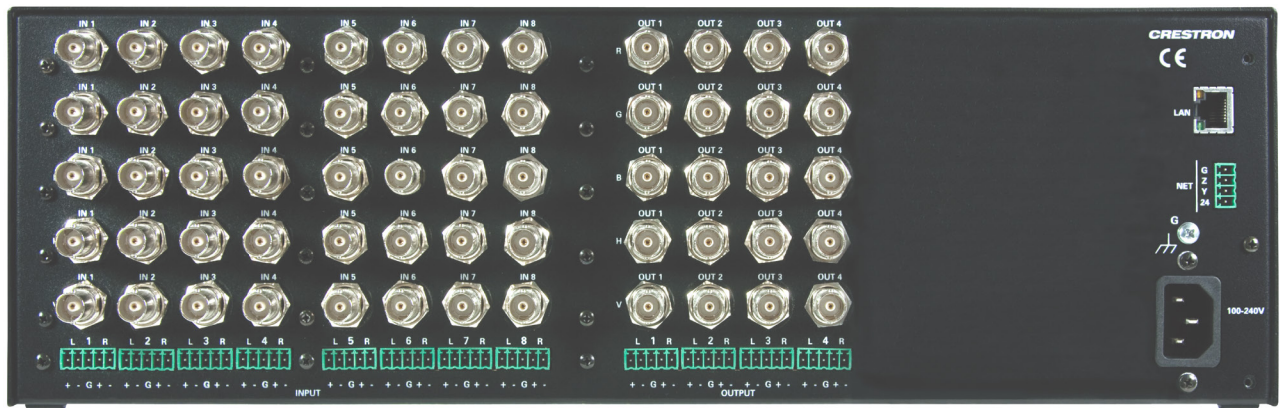

*CEN-RGBHVHB8X8 Front View*



*CEN-RGBHVHB8X8 Rear View*

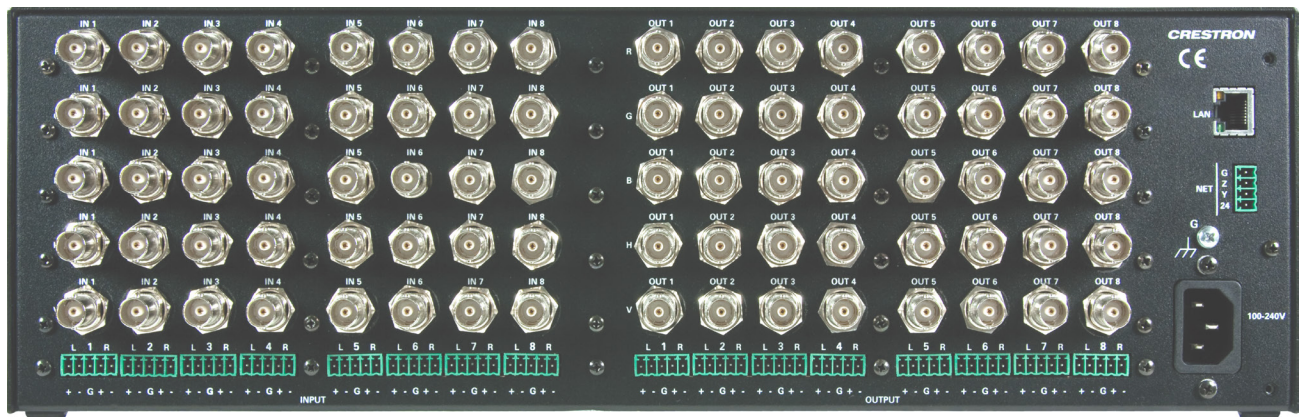

*CEN-RGBHVHB12X4 Front View*



CEN-RGBHVHB12X4 Rear View

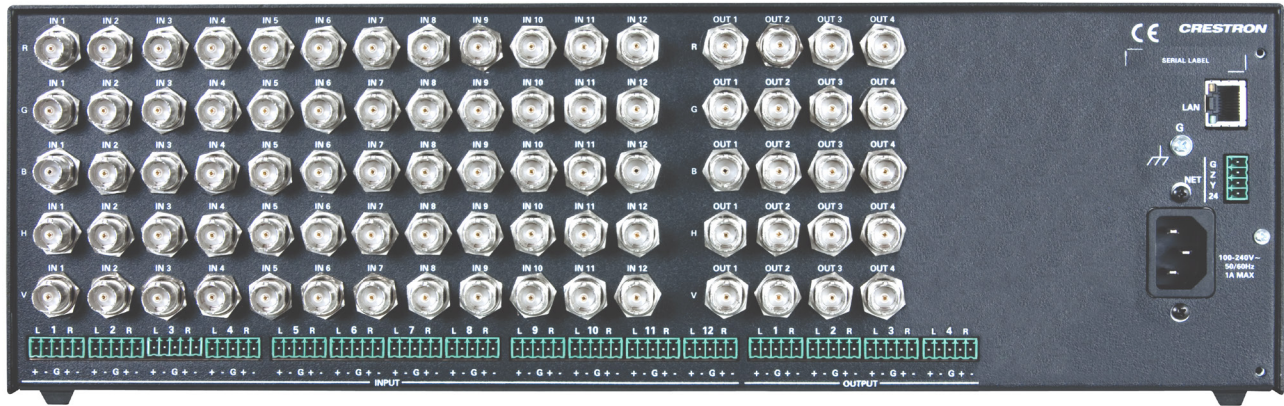

CEN-RGBHVHB12X8 Front View



CEN-RGBHVHB12X8 Rear View

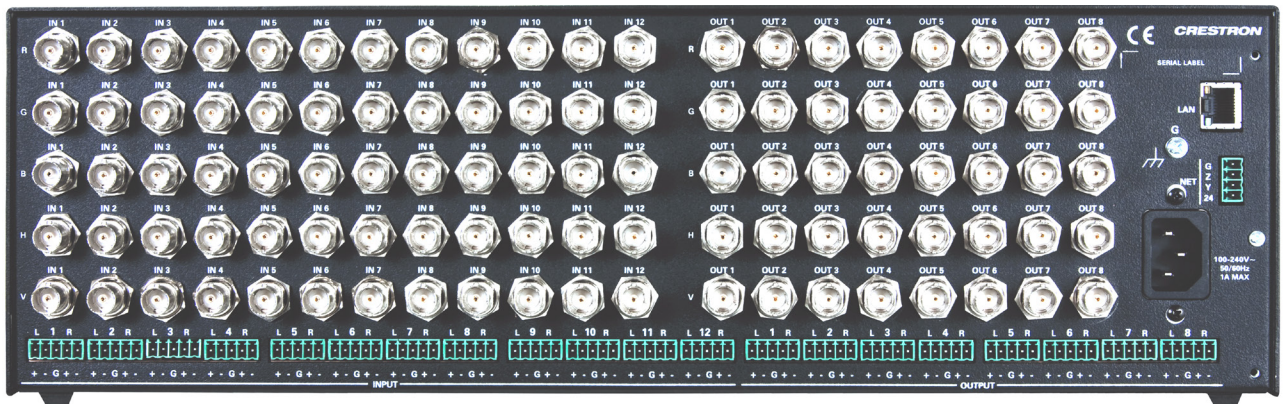

*CEN-RGBHVHB8X4, CEN-RGBHVHB8X8, CEN-RGBHVHB12X4, CEN-RGBHVHB12X8 Overall Dimensions (CEN-RGBHVHB12X8 Shown)*

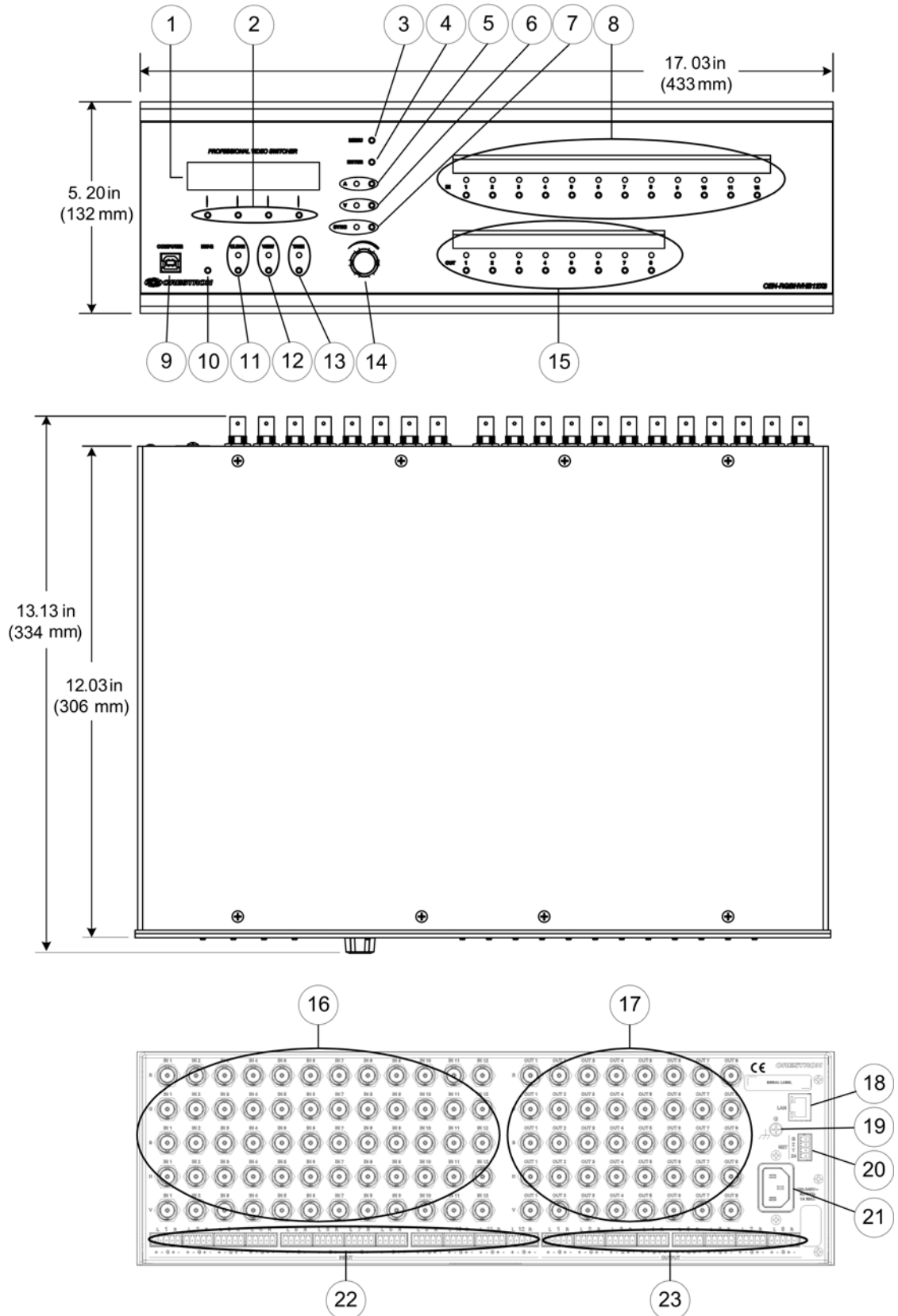



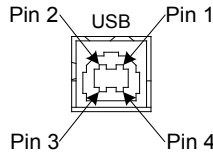

*Connectors, Controls & Indicators*

#	CONNECTORS <sup>1</sup> , CONTROLS & INDICATORS	DESCRIPTION										
1	LCD Display	Green LCD alphanumeric, adjustable backlight, 2 lines x 20 characters per line; Displays inputs/outputs by name, scan rates, audio settings, IP configuration and setup menus										
2	Soft Keys	(4) push buttons for execution of LCD driven functions										
3	MENU	(1) push button, steps menu back one level										
4	ENTER	(1) push button, executes highlighted menu or value										
5	A	(1) push button & red LED, selects audio routing view										
6	V	(1) push button & red LED, selects video routing view										
7	SYNC	(1) push button & red LED, displays input sync rate										
8	IN	(8 or 12) <sup>2</sup> push buttons & red LEDs, select input to be routed										
9	<p>COMPUTER</p> 	<p>(1) USB Type B female; USB computer console port (6 foot cable included)</p> <table border="1" data-bbox="941 1039 1282 1218"> <thead> <tr> <th>PIN</th> <th>DESCRIPTION</th> </tr> </thead> <tbody> <tr> <td>1</td> <td>+5 Vdc</td> </tr> <tr> <td>2</td> <td>Data -</td> </tr> <tr> <td>3</td> <td>Data +</td> </tr> <tr> <td>4</td> <td>Ground</td> </tr> </tbody> </table>	PIN	DESCRIPTION	1	+5 Vdc	2	Data -	3	Data +	4	Ground
PIN	DESCRIPTION											
1	+5 Vdc											
2	Data -											
3	Data +											
4	Ground											
10	HW-R	(1) recessed miniature push button for hardware reset, reboots the switcher										
11	CLEAR	(1) push button & red LED, clears all matrix routing										
12	VIEW	(1) push button & red LED, toggles View mode on/off										
13	TAKE	(1) push button & red LED, executes routing										
14	Quick-Adjust Knob	(1) continuous turn rotary encoder, adjusts menu parameters										
15	OUT	(4 or 8) <sup>3</sup> push buttons & red LEDs, select output destination(s)										

*(Continued on following page)*

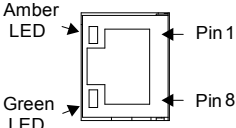

*Connectors, Controls & Indicators (Continued)*

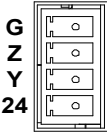
#	CONNECTORS <sup>1</sup> , CONTROLS & INDICATORS	DESCRIPTION																				
16	(VIDEO) IN 	(8 or 12) <sup>2</sup> sets of (5) BNC female; RGB, component, S-video, or composite video inputs; Formats: RGBHV, RGBS, RGsB, YUV, YPbPr, Y/C, NTSC, PAL; RGB input level: 1 Vp-p with ±0.5 Vdc offset maximum; RGB input impedance: 75 Ω nominal; Sync input types: RGBHV, RGBS <sup>4</sup> , RGsB <sup>4</sup> , YPbPr <sup>4</sup> ; Sync input level: 3 to 5 Vp-p; Sync input impedance: 75 or 510 Ω, independently selectable for H and V per input; Sync detection: Reports discrete H and V signal presence and sync rates per input																				
17	(VIDEO) OUT 	(4 or 8) <sup>3</sup> sets of (5) BNC female; RGB, Component, S-video, or composite video outputs; Formats: Same as selected input; RGB output level: Same as selected input; RGB output impedance: 75 Ω nominal; Sync output type: Same as selected input; Sync output level: 5 Vp-p																				
18	LAN 	(1) 8-wire RJ-45 female (8P8C modular jack) with two LED indicators; 10BASE-T/100BASE-TX Ethernet port; Green LED indicates Ethernet link status; Amber LED indicates Ethernet activity; <table border="1" data-bbox="943 1171 1409 1329"> <thead> <tr> <th>PIN</th> <th>SIGNAL</th> <th>PIN</th> <th>SIGNAL</th> </tr> </thead> <tbody> <tr> <td>1</td> <td>TX +</td> <td>5</td> <td>N/C</td> </tr> <tr> <td>2</td> <td>TX -</td> <td>6</td> <td>RC -</td> </tr> <tr> <td>3</td> <td>RC+</td> <td>7</td> <td>N/C</td> </tr> <tr> <td>4</td> <td>N/C</td> <td>8</td> <td>N/C</td> </tr> </tbody> </table>	PIN	SIGNAL	PIN	SIGNAL	1	TX +	5	N/C	2	TX -	6	RC -	3	RC+	7	N/C	4	N/C	8	N/C
PIN	SIGNAL	PIN	SIGNAL																			
1	TX +	5	N/C																			
2	TX -	6	RC -																			
3	RC+	7	N/C																			
4	N/C	8	N/C																			
19	G 	(1) 6-32 screw, chassis ground lug																				
20	NET 	(1) 4-pin 3.5 mm detachable terminal block; Cresnet slave port, connects to Cresnet control network; Does not draw power from the network																				

*(Continued on following page)*

## Connectors, Controls &amp; Indicators (Continued)

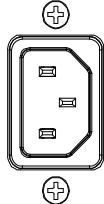
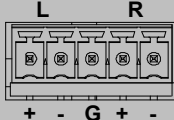
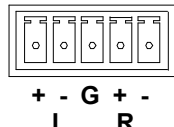
#	CONNECTORS <sup>1</sup> , CONTROLS & INDICATORS	DESCRIPTION
21	100-240V ~50/60Hz 1.0A Max 	(1) IEC C14 male chassis plug, main power input; Mates with removable power cord (included)
22	(AUDIO) IN 	(8 or 12) <sup>2</sup> 5-pin 3.5 mm detachable terminal blocks; Balanced/unbalanced stereo line level inputs; Maximum input level: 4 Vrms balanced, 2 Vrms unbalanced; Input impedance: 24 k $\Omega$ balanced, 12 k $\Omega$ unbalanced <hr/> <b>NOTE:</b> Last input (8 or 12) may be configured for <i>Paging</i> mode
23	AUDIO OUT (L/R) 	(4 or 8) <sup>3</sup> 5-pin 3.5 mm detachable terminal blocks; Balanced/unbalanced stereo line level outputs; Maximum output level: 4 Vrms balanced, 2 Vrms unbalanced; Output impedance: 200 $\Omega$ balanced, 100 $\Omega$ unbalanced.

- Interface connectors for the NET port and the (Audio) INPUT and OUTPUT ports are provided with the unit.
- 1 – 8 on CEN-RGBHVHB8X4 and CEN-RGBHVHB8X8; 1 – 12 on CEN-RGBHVHB12X4 and CEN-RGBHVHB12X8.
- 1 – 4 on CEN-RGBHVHB8X4 and CEN-RGBHVHB12X4; 1 – 8 on CEN-RGBHVHB8X8 and CEN-RGBHVHB12X8.
- Sync detection reports discrete H and V signals only.

---

## Setup

### Network Wiring

When wiring the Cresnet network, consider the following:

- Use Crestron Certified Wire.
- Use Crestron power supplies for Crestron equipment.
- Provide sufficient power to the system.

---

**CAUTION:** Insufficient power can lead to unpredictable results or damage to the equipment. Use the Crestron Power Calculator to help calculate how much power is needed for the system ([www.crestron.com/calculators](http://www.crestron.com/calculators)).

---

For Cresnet networks with 20 or more devices, use a Cresnet Hub/Repeater (CNXHUB) to maintain signal quality.

For more details, refer to “Check Network Wiring” which starts on page 43.

The CEN-RGBHVHB can also use high-speed Ethernet for communications between the device and a control system.

For general information on connecting Ethernet devices in a Crestron system, refer to the latest version of the Crestron e-Control<sup>®</sup> Reference Guide (Doc. 6052), which is available from the Crestron Web site ([www.crestron.com/manuals](http://www.crestron.com/manuals)).

### Identity Code

---

**NOTE:** The latest software can be downloaded from the Crestron Web site ([www.crestron.com/software](http://www.crestron.com/software)).

---

#### Net ID

The Net ID of the CEN-RGBHVHB has been factory set to **33**. The Net IDs of multiple CEN-RGBHVHB devices in the same system must be unique. Net IDs are changed from a personal computer (PC) via Crestron Toolbox (refer to “Establishing Communication” which starts on page 18).

When setting the Net ID, consider the following:

- The Net ID of each unit must match an ID code specified in the Crestron Studio or SIMPL Windows program.
- Each network device must have a unique Net ID.

For more details, refer to the Crestron Toolbox help file.

#### IP ID

The IP ID is set within the CEN-RGBHVHB’s IP table using Crestron Toolbox. For information on setting an IP table, refer to the Crestron Toolbox help file. The IP IDs of multiple CEN-RGBHVHB devices in the same system must be unique.

When setting the IP ID, consider the following:

- The IP ID of each unit must match an IP ID specified in the Crestron Studio or SIMPL Windows program.
- Each device using IP to communicate with a control system must have a unique IP ID.

## Installation

### Ventilation

The CEN-RGBHVHB should be used in a well-ventilated area. The venting holes should not be obstructed under any circumstances.

To prevent overheating, do not operate this product in an area that exceeds the environmental temperature range listed in the table of specifications. Consider using forced air ventilation and/or incrementing the spacing between units to reduce overheating. Contact with thermal insulating materials should be avoided on all sides of the unit.

### Rack Mounting

The CEN-RGBHVHB can be mounted in a rack or stacked with other equipment. Two “ears” and an appropriate number of longer screws are provided with the CEN-RGBHVHB so that the unit can be rack mounted. These ears must be installed prior to mounting. Complete the following procedure to attach the ears to the unit. The only tool required is a #1 or #2 Phillips screwdriver.

---

**WARNING:** To prevent bodily injury when mounting or servicing this unit in a rack, observe the following guidelines:

- When mounting this unit in a partially filled rack, load the rack from the bottom to the top with the heaviest component at the bottom of the rack.
- If the rack is provided with stabilizing devices, install the stabilizers before mounting or servicing the unit in the rack.

**NOTE:** Observe the following guidelines when installing equipment in a rack:

- Elevated Operating Ambient Temperature - If installed in a closed or multi-unit rack assembly, the operating ambient temperature of the rack environment may be greater than room ambient temperature. Therefore, consideration should be given to installing the equipment in an environment compatible with the maximum ambient temperature (T<sub>ma</sub>) specified by the manufacturer.
- Reduced Air Flow - Installation of the equipment in a rack should be such that the amount of airflow required for safe operation of the equipment is not compromised.
- Mechanical Loading - Mounting of the equipment in the rack should be such that a hazardous condition is not achieved due to uneven mechanical loading.
- Circuit Overloading - Consideration should be given to the connection of the equipment to the supply circuit and the effect that overloading of the circuits might have on overcurrent protection and supply wiring. Appropriate consideration of equipment nameplate ratings should be used when addressing this concern.
- Reliable Earthing - Reliable earthing of rack-mounted equipment should be maintained. Particular attention should be given to supply connections other than direct connections to the branch circuit (e.g., use of power strips)

**NOTE:** If rack mounting is not required, rubber feet are provided for tabletop mounting or stacking. Apply the feet near the corner edges on the underside of the unit.

---

To install the ears:

---

**CAUTION:** To prevent equipment damage, use only the rack ears Crestron provides for this device.

---

1. There are screws that secure each side of the CEN-RGBHVHB top cover. Using a #1 or #2 Phillips screwdriver, remove the three screws closest to the front panel from one side of the unit. Refer to the diagram following step 3 for a detailed view.
2. Position a rack ear so that its mounting holes align with the holes vacated by the screws in step 1.
3. Secure the ear to the unit using the longer #6-32 screws that came packed separately with the unit, as shown in the following diagram.

*Ear Attachment for Rack Mounting*

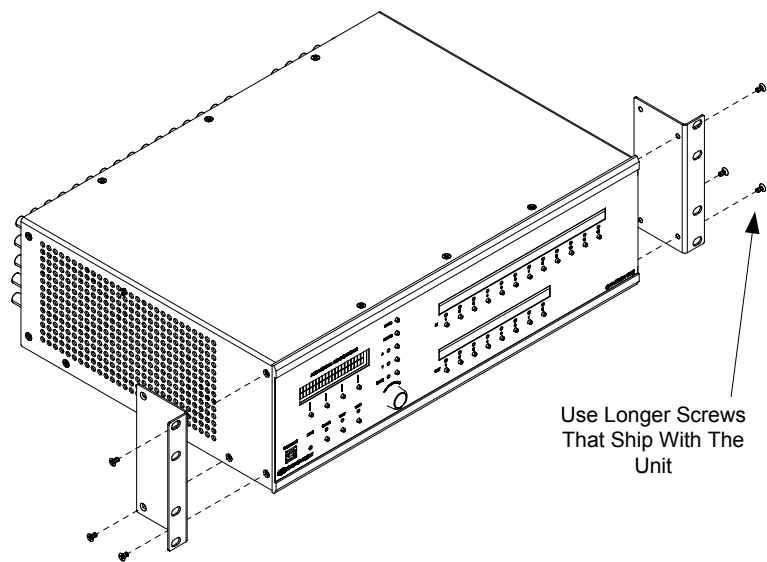

4. Repeat procedure (steps 1 through 3) to attach the remaining ear to the opposite side.

**Stacking**

Four “feet” are provided with the CEN-RGBHVHB so that if the unit is not rack mounted, the rubber feet can provide stability when the unit is placed on a flat surface or stacked. These feet should be attached prior to the hookup procedure. Refer to the following illustration for placement of the feet.

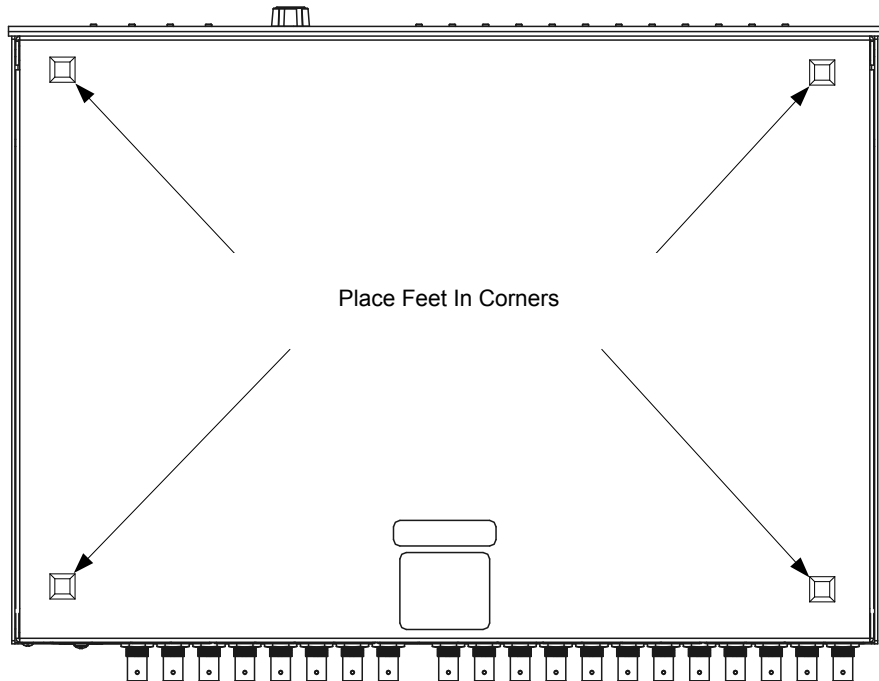
**Foot Placement for the CEN-RGBHVHB**

---

**NOTE:** No more than two CEN-RGBHVHB units should be stacked.

---

## Hardware Hookup

**Connect the Device**

Make the necessary connections as called out in the illustration that follows this paragraph. Refer to “Network Wiring” on page 13 before attaching the 4-position terminal block connector. Apply power after all connections have been made.

When making connections to the CEN-RGBHVHB, note the following:

- Use Crestron power supplies for Crestron equipment.
- The included cable cannot be extended.

*Hardware Connections for the CEN-RGBHVHB*

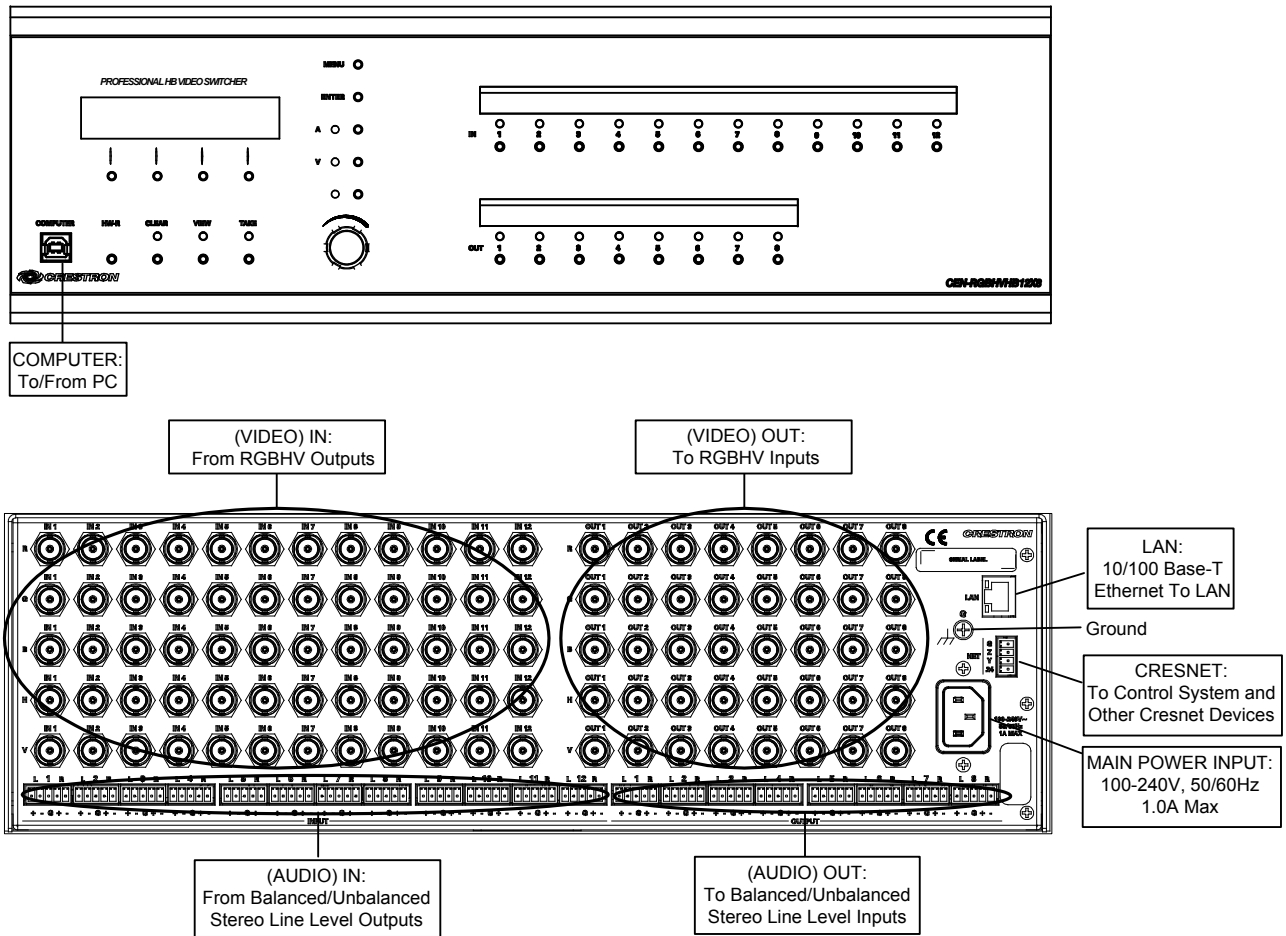

**NOTE:** Ensure the unit is properly grounded by connecting the chassis ground lug to an earth ground (building steel).

**NOTE:** To prevent overheating, do not operate this product in an area that exceeds the environmental temperature range listed in the table of specifications.

**NOTE:** To obtain the best performance from the switcher, Crestron recommends that unused video outputs not be routed to any inputs.

**Label the Buttons**

Use Crestron Engraver software to print custom labels for the CEN-RGBHVHB’s front panel buttons and LEDS. Crestron recommends printing on 100-pound paper. Paper weighing less than 100 pounds tends to crumple while sliding in, while paper weighing more than 100 pounds may not fit.

## Uploading and Upgrading

Crestron recommends using the latest programming software and that each device contains the latest firmware to take advantage of the most recently released features. However, before attempting to upload or upgrade it is necessary to establish communication. Once communication has been established, files (for example, programs or firmware) can be transferred to the control system (and/or device). Finally, program checks can be performed (such as changing the device ID or creating an IP table) to ensure proper functioning.

**NOTE:** Crestron software and any files on the Web site are for authorized Crestron dealers and Crestron Service Providers (CSPs) only. New users may be required to register to obtain access to certain areas of the site (including the FTP site).

### Establishing Communication

Use Crestron Toolbox for communicating with the CEN-RGBHVHB; refer to the Crestron Toolbox help file for details. There are three methods of communication: indirect, USB and TCP/IP.

#### Indirect

##### Indirect Communication

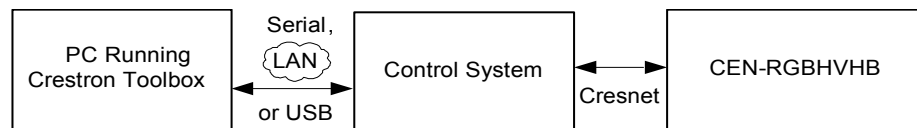

CEN-RGBHVHB connects to control system via Cresnet:

1. Establish communication between the PC and the control system as described in the latest version of the 2-Series Control Systems Reference Guide (Doc. 6256).
2. Use the Address Book in Crestron Toolbox to create an entry for the CEN-RGBHVHB using the expected communication protocol (indirect). Select the Cresnet ID of the CEN-RGBHVHB and the address book entry of the control system that is connected to the CEN-RGBHVHB.
3. Display the CEN-RGBHVHB's "System Info" window (click the **i** icon); communications are confirmed when the device information is displayed.

#### USB

**NOTE:** Required for initial setup of Ethernet parameters.

**NOTE:** Required for loading projects and firmware.

##### USB Communication

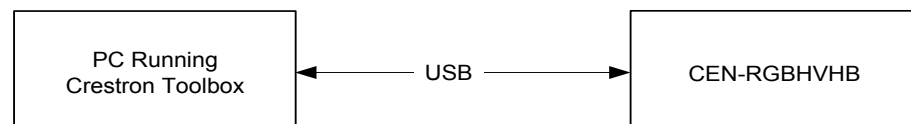



The **COMPUTER** port on the CEN-RGBHVHB connects to the USB port on the PC via the included Type A to Type B USB cable:

1. Use the Address Book in Crestron Toolbox to create an entry using the expected communication protocol (USB). When multiple USB devices are connected, identify the CEN-RGBHVHB by entering “CEN-RGBHVHB” in the *Model* textbox, the unit’s serial number in the *Serial* textbox or the unit’s hostname in the *Hostname* textbox. The hostname can be found in the “System Info” window in the section marked *Ethernet* however, communications must be established in order to see this information in the “System Info” window.
2. Display the CEN-RGBHVHB’s “System Info” window (click the  icon); communications are confirmed when the device information is displayed.

#### TCP/IP

**NOTE:** Required for operation with a Crestron control system.

#### Ethernet Communication

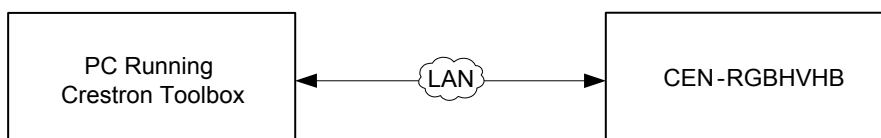

The CEN-RGBHVHB connects to PC via Ethernet:

1. Establish serial communication between CEN-RGBHVHB and PC.
2. Confirm Ethernet connection between CEN-RGBHVHB and PC. If connecting through a hub or router, use CAT5 straight through cables with 8-pin RJ-45 connectors. Alternatively, use a CAT5 crossover cable to connect the two LAN ports directly without using a hub or router.
3. Use the Device Discovery Tool in Crestron Toolbox to detect all Ethernet devices on the network and their IP configuration. The tool is available in Toolbox version 1.15.143 or later.
4. Use the Address Book in Crestron Toolbox to create an entry for the CEN-RGBHVHB with the CEN-RGBHVHB’s TCP/IP communication parameters.
5. Display the “System Info” window (click the  icon) and select the CEN-RGBHVHB entry from the Address Book or the Address Book drop-down list.

## Programs and Firmware

Program or firmware files may be distributed from programmers to installers or from Crestron to dealers. Firmware upgrades are available from the Crestron Web site as new features are developed after product releases. One has the option to upload programs via the programming software or to upload and upgrade via the Crestron Toolbox. For details on uploading and upgrading, refer to the Crestron Studio help file, the SIMPL Windows help file or the Crestron Toolbox help file.

#### Crestron Studio / SIMPL Windows

If a Crestron Studio or SIMPL Windows program is provided, it can be uploaded to the control system using Crestron Studio, SIMPL Windows or Crestron Toolbox.

#### Firmware

Check the Crestron Web site to find the latest firmware. (New users must register to obtain access to certain areas of the site, including the FTP site.)

Upgrade CEN-RGBHVHB firmware via Crestron Toolbox.

1. Establish communication with the CEN-RGBHVHB and display the “System Info” window.
2. Select **Functions | Firmware...** to upgrade the CEN-RGBHVHB firmware.

## Program Checks

Actions that can be performed on the CEN-RGBHVHB vary depending on whether it is connected via Cresnet or Ethernet.

### *Cresnet Connections*

For Cresnet connections, using Crestron Toolbox, display the network device tree (**Tools | Network Device Tree View**) to show all network devices connected to the control system. Right-click on the CEN-RGBHVHB to display actions that can be performed on the CEN-RGBHVHB.

### *Ethernet Connections*

For Ethernet connections, using Crestron Toolbox, display the “System Info” window (click the  icon) and select the **Functions** menu to display actions that can be performed on the CEN-RGBHVHB.

Be sure to use Crestron Toolbox to create the CEN-RGBHVHB IP table.

1. Select **Functions | IP Table Setup**.
2. Add, modify or delete entries in the IP table. The CEN-RGBHVHB can have only one IP table entry.
3. A defined IP table can be saved to a file or sent to the device.

Edit the control system’s IP table to include an entry for the CEN-RGBHVHB. The entry should list the CEN-RGBHVHB’s IP ID (specified on the CEN-RGBHVHB’s IP table) and the internal gateway IP address 127.0.0.1.

# Operation

## Menu Structure

The overall front panel menu structure of the CEN-RGBHVHB is shown in the following illustration. Subsequent paragraphs describe the individual pages and their functions.

*CEN-RGBHVHB Menu Structure*

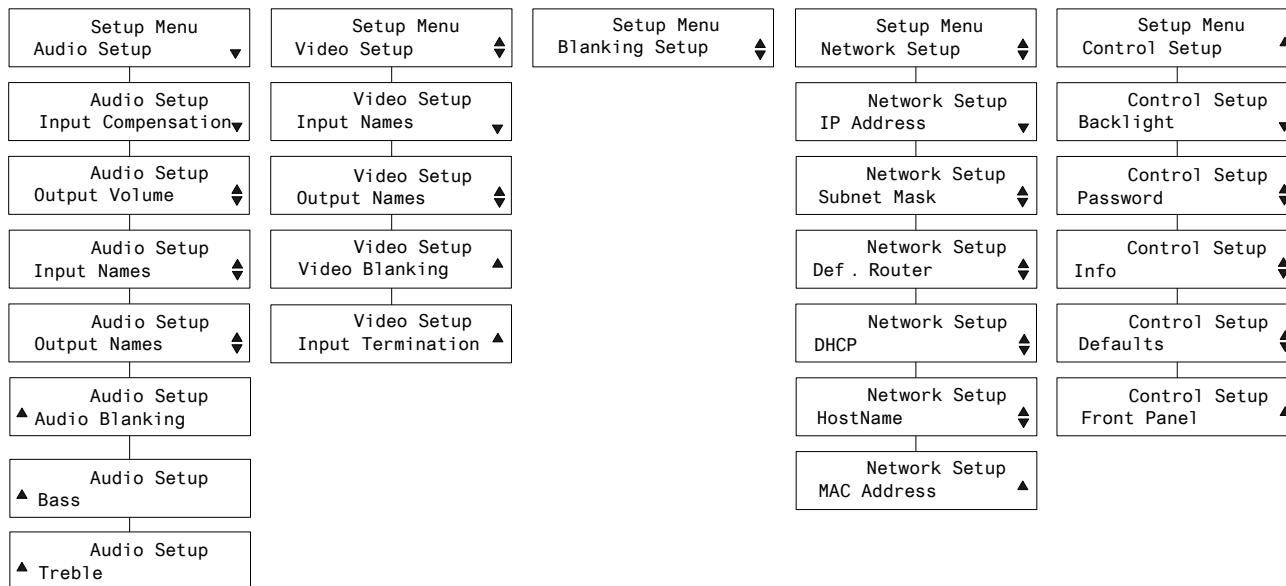

## Setup and Informational Screens

The following paragraphs describe the various setup and informational screens that are available with the CEN-RGBHVHB. These are accessed using the **MENU** button on the front panel.

There are five categories within the menu structure:

- Audio Setup
- Video Setup
- Blanking Setup
- Network Setup
- Control Setup

When the **MENU** button is pressed, the system requests a password, as shown in the two illustrations that follow.

*“Enter Password” Screen*

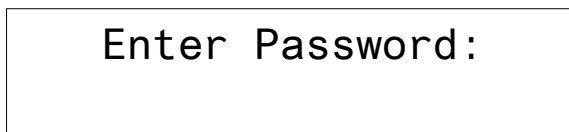

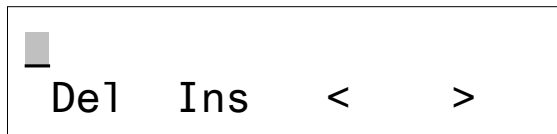
*Password Entry Screen*

The default password for the CEN-RGBHVHB is 12345. You can change the password using the Control Setup / Password screen (refer to “Control: Password” on page 40).

Use the buttons below the < and > symbols on the display to navigate to a digit to set. Use the buttons below **Del** and **Ins** to delete and/or insert digits. Change a digit by rotating the quick-adjust knob. When the password is entered, press **ENTER** to go to the setup menus.

When the setup menus are used for the first time, after password entry, the system displays the main “Audio Setup” screen. If the setup menus have previously been used, the system displays the first screen in the last used category. From any of the top level menus, a different category can be selected by using the rotary quick-adjust knob on the front panel.

---

**NOTE:** The ▲ and ▼ symbols in the lower right corner of the display show whether there are screens available above and/or below the presently displayed screen.

---

To exit the Setup Menu screens, press the **MENU** button repeatedly until the **Exit Setup Menu** screen appears, as shown below. (The number of presses required varies depending on the current location in the menu structure.) Then press the button below **Yes**.

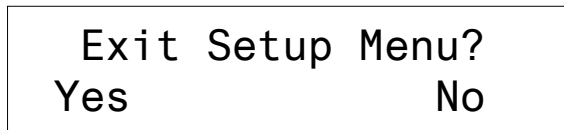
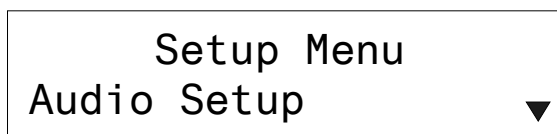
*“Exit Setup Menu” Screen***Audio Setup***“Audio Setup” Screen*

Press the **ENTER** button to select a parameter of the “Audio Setup” menu to view. From any of the parameter level menus, a different parameter can be selected by using the rotary quick-adjust knob on the front panel.

For example, pressing the **ENTER** button from the Audio Setup menu displays one of the following parameters:

- Input Compensation
- Output Volume
- Input Names

- Output Names
- Audio Blanking
- Bass
- Treble

Change to any of the other parameters of the “Audio Setup” menu using the quick-adjust knob. Press the **ENTER** button when the desired parameter appears on the screen.

*Audio:  
Input Compensation*

*“Input Compensation” Screen*



Input Compensation allows adjustment of the gain for the selected input. To adjust input gain, press the **ENTER** button.

*Input Compensation Screen 2*

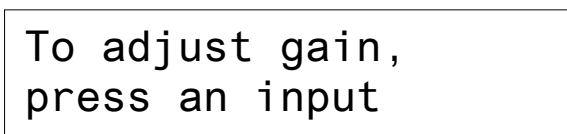

Press a front panel **IN** button to select an input to adjust.

For example, to raise the input level for the source connected to input number **1**, press the **IN** button below **1** on the front panel. The LED above **IN 1** lights and the current gain setting for input 1 is displayed.

*“Input 1 Comp.” Screen*

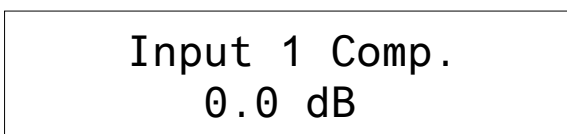

Use the quick-adjust knob to change the gain. In this example, the gain is raised 0.5 dB. The display shows the change in gain along with a bar graph.

*“Gain” Screen*

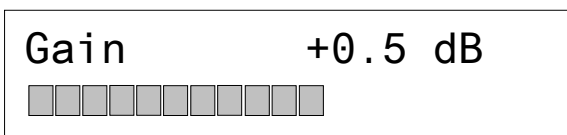

Press **ENTER** to return the display to the “Input Compensation” screen. Press **ENTER** to select another input or use the quick-adjust knob to select another Audio Setup parameter. The next parameter is Output Volume.

Audio:  
Output Volume

*“Output Volume” Screen*

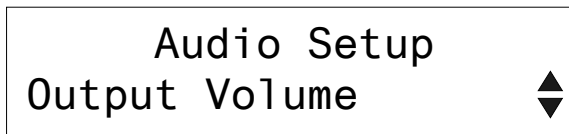

To adjust output volume, press the **ENTER** button.

*Output Volume Screen 2*



Press a front panel **OUT** button to select an output to adjust.

For example, to lower the output level for output number **1**, press the **OUT** button below **1** on the front panel. The LED above **OUT 1** lights and the current output level setting for output 1 is displayed.

*“Output 1 Vol.” Screen*

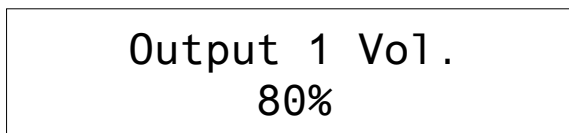

Use the quick-adjust knob to change the output level. In this example, the output level is lowered by 1%. The display shows the change in output level along with a bar graph.

*“Volume” Screen*

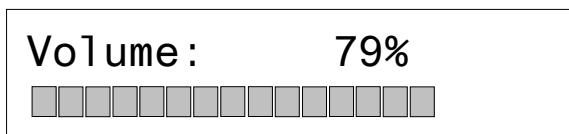

Press **ENTER** to return the display to the “Output Volume” screen. Press **ENTER** to select another input or use the quick-adjust knob to select another Audio Setup parameter. The next parameter is Input Names.

Audio:  
Input Names

*“Input Names” Screen*

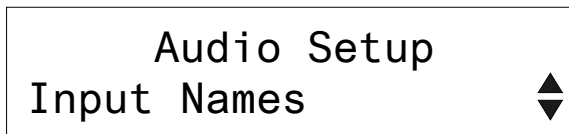

To set up an input name, press the **ENTER** button.

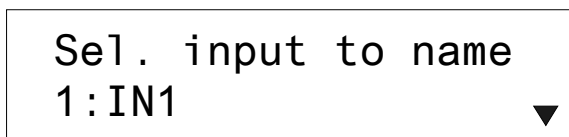
*“Sel. input to name” Screen*

Use the quick-adjust knob to select the input being named. Then press **ENTER**.

*Input Name Setup Screen*

Use the buttons below the < and > symbols on the display to navigate to a digit to set. Use the buttons below **Del** and **Ins** to delete and/or insert digits. Change a digit by rotating the quick-adjust knob.

Press **ENTER** to save the new setting. The display returns to the “Sel. input to name” screen. Use the quick-adjust knob to select another input or press **MENU** to return to the “Input Names” screen. From the “Input Names” screen, use the quick-adjust knob to select another Audio Setup parameter. The next parameter is Output Names.

*Audio:*  
Output Names

*“Output Names” Screen*

To set up an output name, press the **ENTER** button.

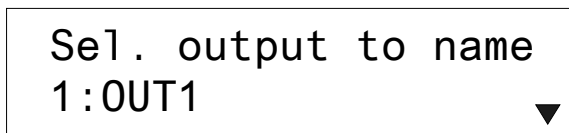
*“Sel. output to name” Screen*

Use the quick-adjust knob to select the output being named. Then press **ENTER**.

*Output Name Setup Screen*

Use the buttons below the < and > symbols on the display to navigate to a digit to set. Use the buttons below **Del** and **Ins** to delete and/or insert digits. Change a digit by rotating the quick-adjust knob.

Press **ENTER** to save the new setting. The display returns to the “Sel. output to name” screen. Use the quick-adjust knob to select another output or press **MENU** to return to the “Output Names” screen. From the “Output Names” screen, use the

quick-adjust knob to select another Audio Setup parameter. The next parameter is Audio Blanking.

---

**NOTE:** Blanking may be enabled/disabled separately for audio and video. Blanking is used to ensure that no flickering occurs on the video output as the new sync signals are sent to the display. Audio blanking may be used to mute the audio signal during video blanking

---

Audio:  
Audio Blanking

*“Audio Blanking” Screen*



To set audio blanking, press **ENTER**. Use the quick-adjust knob to turn audio blanking on or off.

*Audio Blanking Screen 2*

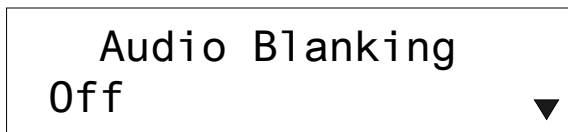

An asterisk to the left of the blanking option shows the current setting.

*Audio Blanking Screen 2 (Showing Blanking Set to On)*

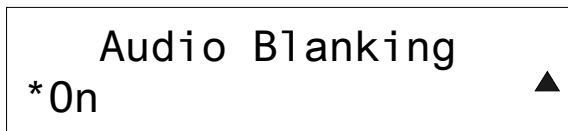

Press **ENTER** to save the new setting. The display returns to the “Audio Blanking” screen. Use the quick-adjust knob to select another Audio Setup parameter or press **MENU** to return to the “Audio Setup” category screen.

Use the quick-adjust knob to select another parameter. The next parameter is Audio Setup Bass.

Audio:  
Bass

*“Audio Setup -- Bass” Screen*

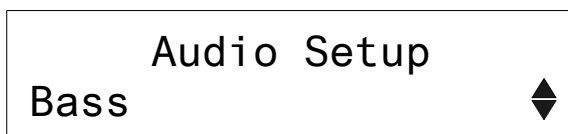

Press **ENTER** to adjust bass settings.

*Adjust Bass Screen*

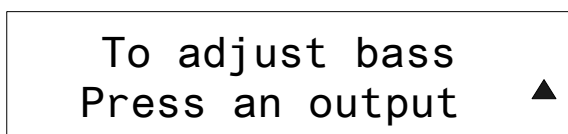



Press an appropriate **OUT** button. The display shows the current bass setting for that output.

*Bass Setting Screen*

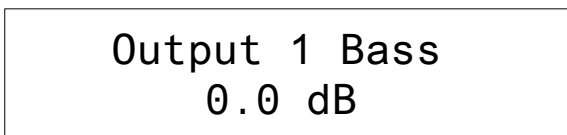

To adjust the setting, use the quick-adjust knob to set bass gain between -15.0 dB and +15.0 dB

*Bass Gain Setting Screen*

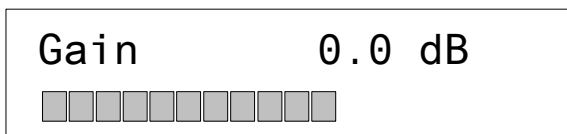

Press **ENTER** to accept the setting. Press **ENTER** again to adjust the bass gain for another output; or press **MENU** to return to the "Audio Setup" category screen.

Use the quick-adjust knob to select another parameter. The next parameter is Audio Setup Treble.

Audio:  
Treble

*"Audio Setup -- Treble" Screen*

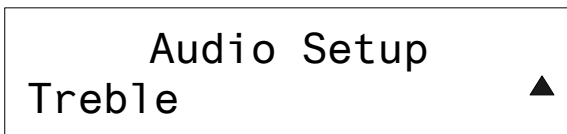

Press **ENTER** to adjust treble settings.

*Audio Treble Screen*

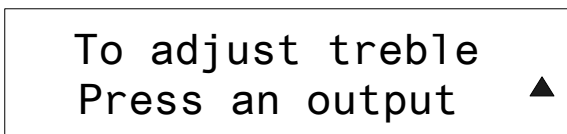

Press an appropriate **OUT** button. The display shows the current treble setting for that output.

*Treble Setting Screen*

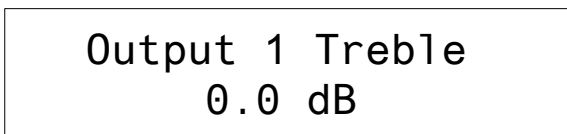

To adjust the setting, use the quick-adjust knob to set treble gain between -15.0 dB and +15.0 dB

*Treble Gain Setting Screen*

Gain	0.0 dB

Press **ENTER** to accept the setting. Press **ENTER** again to adjust the treble gain for another output; or press **MENU** to return to the “Audio Setup” category screen.

Use the quick-adjust knob to select another category. The next category is Video Setup.

**Video Setup***“Video Setup” Screen*

Setup Menu	
Video Setup	

Press the **ENTER** button to select a parameter of the “Video Setup” menu to view. From any of the parameter level menus, select a different parameter by using the rotary quick-adjust knob on the front panel.

For example, pressing the **ENTER** button from the Video Setup menu displays one of the following parameters:

- Input Names
- Output Names
- Video Blanking

Any of the other parameters of the Video Setup menu can be changed using the quick-adjust knob. Press the **ENTER** button when the desired parameter appears on the screen.

*Video:*  
*Input Names*

*“Input Names” Screen*

Video Setup	
Input Names	

To set up an input name, press the **ENTER** button.

*“Sel. input to name” Screen*

Sel. input to name	
1:IN1	

Use the quick-adjust knob to select the input being named. Then press **ENTER**.

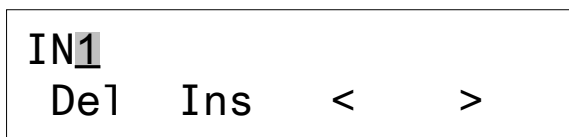
*Input Name Setup Screen*

Use the buttons below the < and > symbols on the display to navigate to the being set. Use the buttons below **Del** and **Ins** to delete and/or insert digits. Change a digit by rotating the quick-adjust knob.

Press **ENTER** to save the new setting. The display returns to the “Sel. input to name” screen. Use the quick-adjust knob to select another input or press **MENU** to return to the “Input Names” screen. From the “Input Names” screen, use the quick-adjust knob to select another Video Setup parameter. The next parameter is Output Names.

Video:  
Output Names

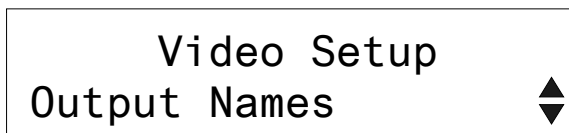
*“Output Names” Screen*

To set up an output name, press the **ENTER** button.

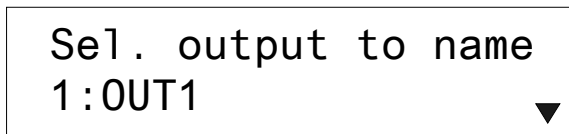
*“Sel. output to name” Screen*

Use the quick-adjust knob to select the output being named. Then press **ENTER**.

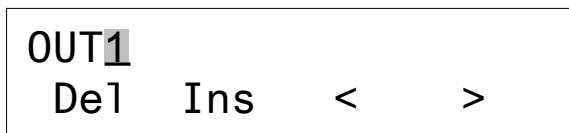
*Output Name Setup Screen*

Use the buttons below the < and > symbols on the display to navigate to a digit to set. Use the buttons below **Del** and **Ins** to delete and/or insert digits. Change a digit by rotating the quick-adjust knob.

Press **ENTER** to save the new setting. The display returns to the “Sel. output to name” screen. Use the quick-adjust knob to select another output or press **MENU** to return to the “Output Names” screen. From the “Output Names” screen, use the quick-adjust knob to select another Video Setup parameter. The next parameter is Video Blanking.

---

**NOTE:** Blanking may be enabled/disabled separately for audio and video. Blanking is used to ensure that no flickering occurs on the video output as the new sync signals are sent to the display. Audio blanking may be used to mute the audio signal during video blanking.

---

Video:  
Video Blanking

*“Video Blanking” Screen*

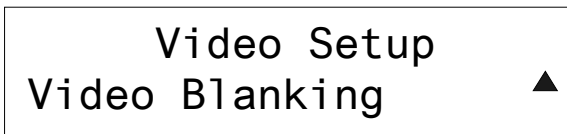

To set video blanking, press **ENTER**. Use the quick-adjust knob to turn audio blanking on or off.

*Video Blanking Screen 2*



An asterisk to the left of the blanking option shows the current setting.

*Video Blanking Screen 2 (Showing Blanking Set to On)*

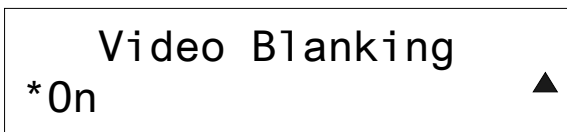

Press **ENTER** to save the new setting. The display returns to the “Video Blanking” screen.

Use the quick-adjust knob to select another Video Setup parameter. The next parameter is Input Termination.

Video:  
Input Termination

*“Input Termination” Screen*

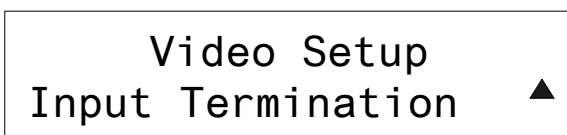

To set input termination, press **ENTER**.

*“Input Termination” Screen 2*

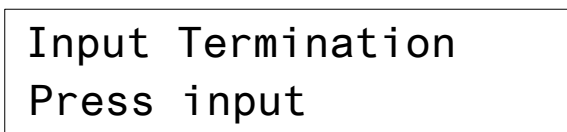

Input termination can be set to 75 or 510 Ω. Press an appropriate **IN** button to verify or change the current setting.

*“Input Termination” Selection Screen*



---

**NOTE:** Input termination impedance settings are applied to the H and V sync connections for the selected input.

---

Press **ENTER** to select between the two values; press **MENU** to accept the desired value and return to the “Video Setup” category screen. Use the quick-adjust knob to select another category. The next category is Blanking Setup.

### **Blanking Setup**

#### *“Blanking Setup” Screen*



To set up blanking, press the **ENTER** button

#### *Blanking Setup Screen 2*



Press a front panel **OUT** button to select an output to adjust.

For example, to set blanking for output number **1**, press the **OUT** button below **1** on the front panel. The LED above **OUT 1** lights and the current blanking setting for output 1 is displayed.

#### *“Out 1 Blanking” Screen*

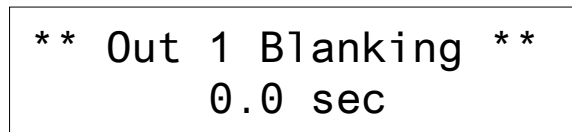

Use the quick-adjust knob to change the blanking time. In this example, the blanking for output 1 is changed from 0 to 0.5 seconds. The display shows the change in blanking time along with a bar graph.

#### *“Blanking” Screen*

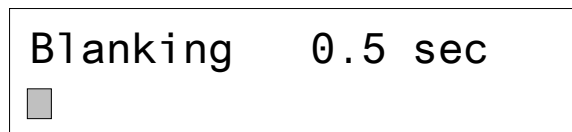

Press **ENTER** to save the new setting. The display returns to the “Blanking Setup” screen. Press **ENTER** to select another output.

Use the quick-adjust knob to select another category. The next category is Network Setup.

## Network Setup

*“Network Setup” Screen*



Press the **ENTER** button to select a parameter of the “Network Setup” menu to view. From any of the parameter level menus, select a different parameter by using the rotary quick-adjust knob on the front panel.

For example, pressing the **ENTER** button from the Network Setup menu displays one of the following parameters:

- IP Address
- Subnet Mask
- Def. Router
- DHCP
- HostName
- MAC Address

Any of the other parameters of the Network Setup menu can be changed using the quick-adjust knob. Press the **ENTER** button when the desired parameter appears on the screen.

*Network:  
IP Address*

*“IP Address” Screen*



To set the IP address, press the **ENTER** button.

*IP Address Screen 2*

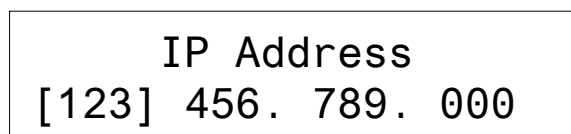

Use the quick adjust knob to set the values for the first three digits in the IP address. Then press **ENTER** to move the brackets to the next three digits and use the quick-adjust knob to set the values for these. Use the **ENTER** button and quick-adjust knob to set the values for next two groups of three digits.

Press **ENTER** to save the IP address. The display returns to the “IP Address” screen. Use the quick-adjust knob to select another Network Setup parameter. The next parameter is Subnet Mask.

Network:  
Subnet Mask

*“Subnet Mask” Screen*

Network Setup  
Subnet Mask 

To set the subnet mask, press the **ENTER** button.

*Subnet Mask Screen 2*

Subnet Mask  
[255] 255. 255. 000

Use the quick adjust knob to set the values for the first three digits in the subnet mask. Then press **ENTER** to move the brackets to the next three digits and use the quick-adjust knob to set the values for these. Use the **ENTER** button and quick-adjust knob to set the values for next two groups of three digits.

Press **ENTER** to save the subnet mask. The display returns to the “Subnet Mask” screen. Use the quick-adjust knob to select another Network Setup parameter. The next parameter is Def. Router.

Network:  
Def. Router

*“Def. Router” Screen*

Network Setup  
Def. Router 

To set the default router, press the **ENTER** button.

*Def. Router Screen 2*

Def. Router  
[123] 456. 789. 000

Use the quick adjust knob to set the values for the first three digits in the default router. Then press **ENTER** to move the brackets to the next three digits and use the quick-adjust knob to set the values for these. Use the **ENTER** button and quick-adjust knob to set the values for next two groups of three digits.

Press **ENTER** to save the default router. The display returns to the “Def. Router” screen. Use the quick-adjust knob to select another Network Setup parameter. The next parameter is DHCP.

Network:  
DHCP

*“DHCP” Screen*

Network Setup  
DHCP 

To set DHCP, press **ENTER**. Use the quick-adjust knob to turn DHCP on or off.

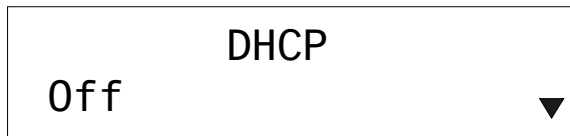
*DHCP Screen 2*

An asterisk to the left of the DHCP option shows the current setting.

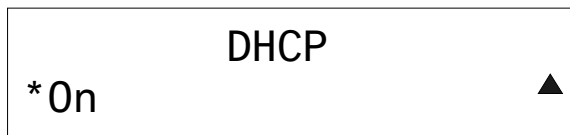
*DHCP Screen 2 (Showing DHCP Set to On)*

Press **ENTER** to save the new setting. The display returns to the “DHCP” screen. Use the quick-adjust knob to select another Network Setup parameter. The next parameter is HostName.

Network:  
HostName

*“HostName” Screen*

To view the host name, press **ENTER**. The display shows the existing host name.

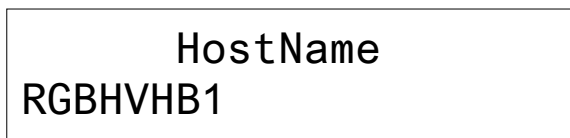
*HostName Screen 2*

To set up the hostname, press **ENTER**.

*HostName Setup Screen*

Use the buttons below the < and > symbols on the display to navigate to a digit to set. Use the buttons below **Del** and **Ins** to delete and/or insert digits. Change a digit by rotating the quick-adjust knob.

Press **ENTER** to save the new setting. The display returns to the “HostName” screen. Use the quick-adjust knob to select another Network Setup parameter. The next parameter is MAC Address.



Network:  
MAC Address

*“MAC Address” Screen*



To display the MAC Address, press **ENTER**.

*Mac Address Screen 2*

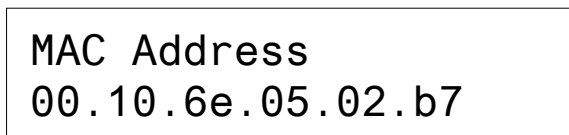

Press **MENU** to return to the “MAC Address” screen.

Use the quick-adjust knob to select another category. The next category is Control Setup.

**Control Setup**

*“Control Setup” Screen*



Press the **ENTER** button to select a parameter of the “Control Setup” menu to view. From any of the parameter level menus, select a different parameter by using the rotary quick-adjust knob on the front panel.

For example, pressing the **ENTER** button from the Control Setup menu displays one of the following parameters:

- Backlight
- Password
- Info
- Defaults
- Front Panel

Any of the other parameters of the “Control Setup” menu can be changed using the quick-adjust knob. Press the **ENTER** button when the desired parameter appears on the screen.

Control:  
Backlight

*“Backlight” Screen*

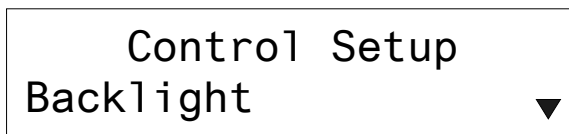

To set the backlight level, press **ENTER**. Use the quick-adjust knob to set the backlight level to low, medium or high.

*Backlight Screen 2*

An asterisk to the left of the backlight option shows the current setting.

*Backlight Screen 2 (Showing Backlight Set to High)*

---

**NOTE:** The backlight setting is in effect while the unit is on. It is not saved across reboots.

---

Press **ENTER** to return the display to the “Backlight” screen. Use the quick-adjust knob to select another Control Setup parameter. The next parameter is Password.

Control:  
Password

*“Password” Screen*

To set a password, press **ENTER**.

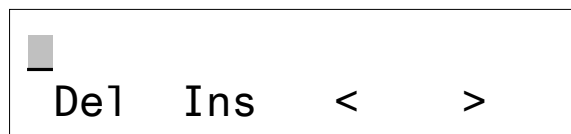
*Password Screen 2*

Use the buttons below the < and > symbols on the display to navigate to a digit to set. Use the buttons below **Del** and **Ins** to delete and/or insert digits. Change a digit by rotating the quick-adjust knob.

Press **ENTER** to save the new setting. The display returns to the “Password” screen. Use the quick-adjust knob to select another Control Setup parameter. The next parameter is Info.

Control:  
Info

*“Info” Screen*

To view information about the CEN-RGBHVHB, press **ENTER**.

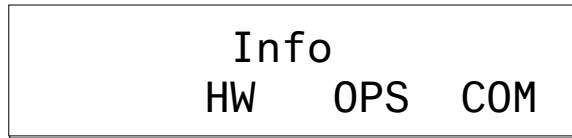
*“Info” Menu*

The Info submenu is divided into **HW** (hardware) **OPS** (operation), and **COM** (communications) sections.

To view information about the CEN-RGBHVHB hardware, press the button below **HW**.

*“Hardware Version” Screen*

---

**NOTE:** Use the buttons below << and >> to scroll through the information on each screen. In the illustration above and several of those that follow, the text has been made smaller to fit all of the information. The actual screen displays require scrolling to see all the information.

---

Use the quick-adjust knob to view other hardware information parameters or press **MENU** to return to the “Info” screen.

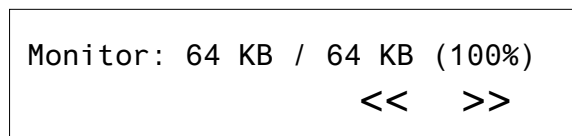
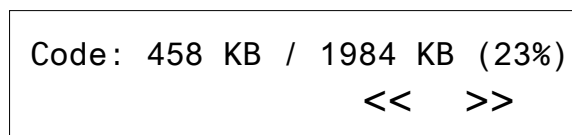
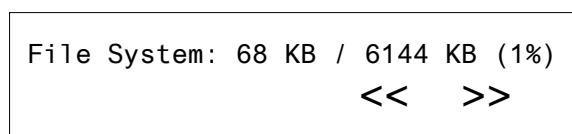
*“FLASH” Screen**Flash “Monitor” Screen**Flash “Code” Screen**Flash “File System” Screen*

*“TOTAL FLASH” Screen*

```
TOTAL FLASH: 8192 KB
                <<  >>
```

*“FLASH unique id” Screen*

```
FLASH unique id: 09b4 2e22 859a 52af
                <<  >>
```

*“RAM” Screen*

```
RAM:
                <<  >>
```

*RAM “Code” Screen*

```
Code: 458 KB / 2153 KB (21%)
                <<  >>
```

*RAM “Initialized Data” Screen*

```
Initialized Data: 6 KB / 2153 KB (0%)
                <<  >>
```

*RAM “Uninitialized Data” Screen*

```
Uninitialized Data: 1684 KB / 2153 KB (0%)
                <<  >>
```

*RAM “Heap” Screen*

```
Heap: 534 KB / 28566 KB (1%)
                <<  >>
```

*RAM “File System” Screen*

```
File System: 0 KB / 2048 KB (0%)
                <<  >>
```

*“TOTAL RAM” Screen*

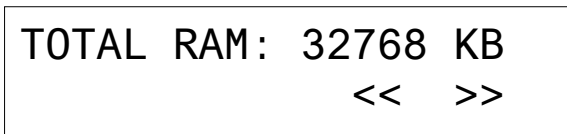

To view the firmware version and serial number of the CEN-RGBHVHB, press **MENU** to return to the “Info” screen then press the button below **OPS**.

*CEN-RGBHVHB Firmware and Serial Number Screen*

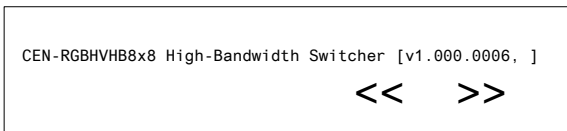

Use the buttons below << and >> to scroll through the information. Press **MENU** to return to the “Info” screen, and press the button below **COM**.

The COM screen displays the communication settings for the CEN-RGBHVHB.

Press **MENU** to return to the “Info” screen. Press **MENU** again to return to the Control Setup menu and use the quick-adjust knob to select another Control Setup parameter. The next parameter is Defaults.

**Control:  
Defaults**

*“Defaults” Screen*



To reset factory defaults, press **ENTER**. Use the quick adjust knob to select whether to restore defaults for Audio settings only, Video setting only, All settings or select Abort to maintain the current settings.

*Defaults Screen 2 (Showing “Audio only” Option)*



An asterisk to the left of the restore defaults option shows the current setting.

*Defaults Screen 2 (Showing “Video only” Option)*

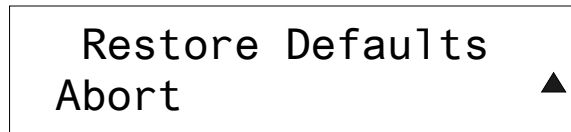

*Defaults Screen 2 (Showing “All settings” Option)**Defaults Screen 2 (Showing “Abort” Option)*

Press **ENTER** to select the new setting. The display asks *Are you sure?* to confirm that default settings should be restored.

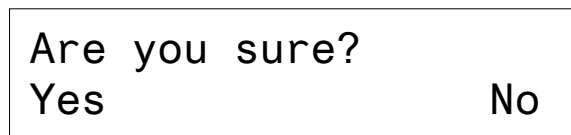
*“Are you sure?” Screen*

To restore defaults, press the button below **Yes**. After a short pause, the screen briefly displays a “Restored defaults” message (if any defaults are reset), then returns to the “Defaults” screen. Use the quick-adjust knob to select another Control Setup parameter. The next parameter is Front Panel.

Control:  
Front Panel

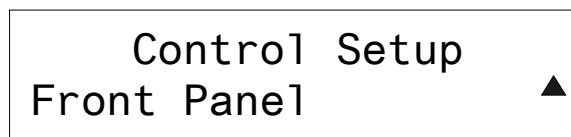
*“Front Panel” Screen*

To turn the front panel lock on or off, press **ENTER**. Use the quick-adjust knob to set the front panel lock on or off.

*Front Panel Screen 2*

An asterisk to the left of the front panel lock option shows the current setting.

Press **ENTER** to save the new setting. The display returns to the “Front Panel” screen. Use the quick-adjust knob to select another Control Setup parameter or press **MENU** to return to the “Control Setup” category screen.

You can then use the quick-adjust knob to select another category or press **MENU** again to display the “Exit Setup Menu” screen.

## Routing Signals

The **VIEW** button causes the display to show which input signals are routed to which outputs. Pressing the **VIEW** button causes the LED above the button to light. The display shows the “View Mode” screen.

---

**NOTE:** At initial startup, default signal routing is input 1 to output 1, input 2 to output 2, etc.

---

### “View Mode” Screen



A rectangular box representing the View Mode screen. Inside the box, the text "IN 1" is positioned above "OUT 1".

In *View* mode, pressing any of the numbered **IN** or **OUT** buttons causes the corresponding LEDs to light, showing the input to output routing.

For example, if the **IN** button **1** is pressed, the LED above **IN 1** lights and the LEDs above any outputs input 1 is routed to also lights. Or, if the **OUT 2** button is pressed, the LED above **OUT 2** lights and the light and the LED above the input that is routed to **OUT 2** also light.

If the **A** button is pressed while in *View* mode, its LED lights and the unit displays the audio routing. If the **V** button is pressed while in *View* mode, its LED lights and the unit displays the video routing.

Pressing the **TAKE** button toggles the unit to *Route* mode. In *Route* mode, the LED above the **VIEW** button is not lit. The display shows the “Route Mode” screen.

### “Route Mode” Screen



A rectangular box representing the Route Mode screen. Inside the box, the text "Route Mode" is positioned above "Press input/outputs".

If the **A** button is pressed, its LED lights and audio signals can be routed. If the **V** button is pressed, its LED lights and video signals can be routed. If both buttons are pressed, both LEDs light and both audio and video signals can be routed simultaneously.

To route signals, select **A**, **V** or both, then press the button for the input signal to route, followed by the **OUT** buttons corresponding to the outputs to route that signal to. Audio and video signals can be routed independently.

The LED below **TAKE** blinks on and off. Press the **TAKE** button to execute the routing that has been selected. The **TAKE** LED stops blinking when routing changes have been executed.

To exit *View* or *Route* mode, press the **MENU** button.

## Sync Mode

To enter *Sync* mode, press the **SYNC** button. The display shows the “Sync Mode” screen.

### “Sync Mode” Screen

A rectangular display box with a black border containing the text "Sync Mode" on the top line and "Press input" on the bottom line, both centered.

Sync Mode  
Press input

To view the horizontal and vertical sync rates of any input, press the numbered **IN** button for the input to view. The display shows the horizontal and vertical sync rates for that input.

For example, to view the sync rates for input number **1**, press the **IN** button below **1** on the front panel. The sync rates for input number 1 is displayed.

### Sync Screen (Showing Horizontal and Vertical Sync Rates for Input 1)

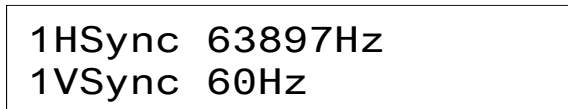
A rectangular display box with a black border containing two lines of text: "1HSync 63897Hz" on the top line and "1VSync 60Hz" on the bottom line, both centered.

1HSync 63897Hz  
1VSync 60Hz

To refresh the current rate, press the numbered **IN** button below the selected input again. A displayed sync rate of 0 Hz indicates that no sync has been detected.

To view the sync rates for a different input, press the numbered **IN** button for the input to view.

To exit *Sync* mode, press the **SYNC** button or press another button such as **VIEW** or **MENU**.

## Paging Mode

The *Paging* mode feature allows an audio signal at the last audio input channel to be distributed to every output, automatically attenuating or “ducking” the signals currently routed, to allow the paging signal to be heard. This feature is enabled/disabled and its parameters are set in firmware. The recommended initial values for each parameter are as follows:

- Mix Input Level: 0
- Threshold: -30
- Depth: -20
- Attack Time: 1
- Hold Time: 1
- Release Time: 150



---

## Problem Solving

### Troubleshooting

The following table provides corrective action for possible trouble situations. If further assistance is required, please contact a Crestron customer service representative.

#### *CEN-RGBHVHB Troubleshooting*

TROUBLE	POSSIBLE CAUSE(S)	CORRECTIVE ACTION
Device does not function.	Device is not communicating with the network.	Use Crestron Toolbox to poll the network. Verify network connection to the device.
	Improper Net ID used.	Verify that device ID matches Net ID in the program.
Poor picture or sound quality.	Cables improperly connected.	Verify all cables are secure.

### Check Network Wiring

#### *Use the Right Wire*

In order to ensure optimum performance over the full range of the installation topology, use Crestron Certified Wire only. Failure to do so may incur additional charges if support is required to identify performance deficiencies because of using improper wire.

#### *Strip and Tin Wire*

When daisy chaining Cresnet units, strip the ends of the wires carefully to avoid nicking the conductors. Twist together the ends of the wires that share a pin on the network connector and tin the twisted connection. Apply solder only to the ends of the twisted wires. Avoid tinning too far up the wires or the end becomes brittle. Insert the tinned connection into the Cresnet connector and tighten the retaining screw. Repeat the procedure for the other three conductors.

#### *Calculate Power*

**CAUTION:** Use only Crestron power supplies for Crestron equipment. Failure to do so could cause equipment damage or void the Crestron warranty.

**CAUTION:** Provide sufficient power to the system. Insufficient power can lead to unpredictable results or damage to the equipment. Use the Crestron Power Calculator to help calculate how much power is needed for the system ([www.crestron.com/calculators](http://www.crestron.com/calculators)).

When calculating the length of wire for a particular Cresnet run, the wire gauge and the Cresnet power usage of each network unit to be connected must be taken into consideration. Use Crestron Certified Wire only. If Cresnet units are to be daisy chained on the run, the Cresnet power usage of each network unit to be daisy chained must be added together to determine the Cresnet power usage of the entire chain. If the unit is run from a Crestron system power supply network port, the Cresnet power usage of that unit is the Cresnet power usage of the entire run. The wire gauge and the Cresnet power usage of the run should be used in the following equation to calculate the cable length value on the equation's left side.

**Cable Length Equation**

$$L < \frac{40,000}{R \times P}$$

Where: L = Length of run (or chain) in feet  
 R = 6 Ohms (Crestron Certified Wire: 18 AWG (0.75 mm<sup>2</sup>))  
 or 1.6 Ohms (Cresnet HP: 12 AWG (4 mm<sup>2</sup>))  
 P = Cresnet power usage of entire run (or chain)

Make sure the cable length value is less than the value calculated on the right side of the equation. For example, a Cresnet run using 18 AWG Crestron Certified Wire and drawing 20 watts should not have a length of run more than 333 feet (101 meters). If Cresnet HP is used for the same run, its length could extend to 1250 feet (381 meters).

---

**NOTE:** All Crestron certified Cresnet wiring must consist of two twisted pairs. One twisted pair is the +24V conductor and the GND conductor and the other twisted pair is the Y conductor and the Z conductor.

---

**Add Hubs**

For larger networks (i.e., greater than 28 network devices), it may become necessary to add a Cresnet Hub/Repeater (CNXHUB) to maintain signal quality throughout the network. Also, for networks with lengthy cable runs it may be necessary to add a Hub/Repeater after only 20 devices.

**Reference Documents**

The latest version of all documents mentioned within the guide can be obtained from the Crestron Web site ([www.crestron.com/manuals](http://www.crestron.com/manuals)).

**List of Related Reference Documents**

DOCUMENT TITLE
2-Series Control Systems Reference Guide
Crestron e-Control Reference Guide

**Further Inquiries**

To locate specific information or to resolve questions after reviewing this guide, contact Crestron's True Blue Support at 1-888-CRESTRON [1-888-273-7876] or refer to the listing of Crestron worldwide offices on the Crestron Web site ([www.crestron.com/offices](http://www.crestron.com/offices)) for assistance within a particular geographic region.

To post a question about Crestron products, log onto the Online Help section of the Crestron Web site ([www.crestron.com/onlinehelp](http://www.crestron.com/onlinehelp)). First-time users must establish a user account to fully benefit from all available features.

**Future Updates**

As Crestron improves functions, adds new features and extends the capabilities of the CEN-RGBHVHB, additional information may be made available as manual updates. These updates are solely electronic and serve as intermediary supplements prior to the release of a complete technical documentation revision.

Check the Crestron Web site periodically for manual update availability and its relevance. Updates are identified as an "Addendum" in the Download column.

---

## Return and Warranty Policies

### Merchandise Returns / Repair Service

1. No merchandise may be returned for credit, exchange or service without prior authorization from Crestron. To obtain warranty service for Crestron products, contact an authorized Crestron dealer. Only authorized Crestron dealers may contact the factory and request an RMA (Return Merchandise Authorization) number. Enclose a note specifying the nature of the problem, name and phone number of contact person, RMA number and return address.
2. Products may be returned for credit, exchange or service with a Crestron Return Merchandise Authorization (RMA) number. Authorized returns must be shipped freight prepaid to Crestron, 6 Volvo Drive, Rockleigh, N.J. or its authorized subsidiaries, with RMA number clearly marked on the outside of all cartons. Shipments arriving freight collect or without an RMA number shall be subject to refusal. Crestron reserves the right in its sole and absolute discretion to charge a 15% restocking fee plus shipping costs on any products returned with an RMA.
3. Return freight charges following repair of items under warranty shall be paid by Crestron, shipping by standard ground carrier. In the event repairs are found to be non-warranty, return freight costs shall be paid by the purchaser.

### Crestron Limited Warranty

Crestron Electronics, Inc. warrants its products to be free from manufacturing defects in materials and workmanship under normal use for a period of three (3) years from the date of purchase from Crestron, with the following exceptions: disk drives and any other moving or rotating mechanical parts, pan/tilt heads and power supplies are covered for a period of one (1) year; touch screen display and overlay components are covered for 90 days; batteries and incandescent lamps are not covered.

This warranty extends to products purchased directly from Crestron or an authorized Crestron dealer. Purchasers should inquire of the dealer regarding the nature and extent of the dealer's warranty, if any.

Crestron shall not be liable to honor the terms of this warranty if the product has been used in any application other than that for which it was intended or if it has been subjected to misuse, accidental damage, modification or improper installation procedures. Furthermore, this warranty does not cover any product that has had the serial number altered, defaced or removed.

This warranty shall be the sole and exclusive remedy to the original purchaser. In no event shall Crestron be liable for incidental or consequential damages of any kind (property or economic damages inclusive) arising from the sale or use of this equipment. Crestron is not liable for any claim made by a third party or made by the purchaser for a third party.

Crestron shall, at its option, repair or replace any product found defective, without charge for parts or labor. Repaired or replaced equipment and parts supplied under this warranty shall be covered only by the unexpired portion of the warranty.

Except as expressly set forth in this warranty, Crestron makes no other warranties, expressed or implied, nor authorizes any other party to offer any warranty, including any implied warranties of merchantability or fitness for a particular purpose. Any implied warranties that may be imposed by law are limited to the terms of this limited warranty. This warranty statement supersedes all previous warranties.



**Crestron Electronics, Inc.**  
15 Volvo Drive Rockleigh, NJ 07647  
Tel: 888.CRESTRON  
Fax: 201.767.7576  
[www.crestron.com](http://www.crestron.com)



**Operations Guide – DOC. 7157C  
(2030038)**

**03.13**

Specifications subject to  
change without notice.