

Crestron Flex UC Video Conference System Integrator Solution for Microsoft Teams® Rooms

The Crestron Flex UC Video Conference System Integrator Solution for Microsoft Teams Rooms ([UC-C160-T](#)) delivers a powerful, professional solution for knowledge workers who want the Microsoft Teams software experience in small to midsize meeting and conference rooms.

The UC-C160-T allows the installer to select audio and camera hardware dictated by the room while offering optional direct or network connection methods between the included system components.

Minimum Requirements

- A video display, connected to the UC-ENGINE. The system supports a second display if desired.
- A Microsoft Teams or Skype® for Business software account

NOTE: The account should be prepared two to three weeks in advance of hardware installation.

- An environment running Microsoft Exchange Server® software (2013 SP1 or later for on-premises installation or Microsoft 365™ software for Cloud) for scheduling and/or Skype for Business 2015 (on-premises installation or Microsoft 365 software for Cloud)
- USB Camera
- AEC-enabled USB speakerphone or DSP device

View the [Crestron Flex Pre-Deployment Checklist](#) to help plan your Crestron Flex installation.



In the Box

UC Engine Bracket Assembly

- 1 UC-BRKT-100-ASSY (6510636)
- 1 Power cord
- 1 Mounting Hardware

Tabletop Touch Screen Device

- 1 TS-1070-B-S-T-V (6511748)

Accessories

- 1 PWE-4803RU, PoE Injector (6502429)
- 2 CBL-CAT5E-7, CAT5e cable, RJ-45-to-RJ-45, Black, 7 ft (2.1 m) (6509924)
- 1 CBL-HD-THIN-HS-6, Thin HDMI® cable, 6 ft (1.8 m) (6510946)
- 1 CBL-HD-20, HDMI cable, 20 ft (6.1 m) (6503567)
- 1 CBL-USBC-HD-9, USB 3.0 to HDMI Converter cable, 9 ft (2.7 m) (6510718)
- 1 DM-CBL-ULTRA-PC-20, DigitalMedia™ Ultra Patch cable, 20 ft (6.1 m) (6507640)

Crestron Flex UC Video Conference System Integrator Solution for Microsoft Teams® Rooms



Overview

The following diagram illustrates standard system connections. Two optional connection methods are available — direct or network connection. Both the direct connection and network connection methods are shown below to help determine the appropriate method for your solution. The room display(s), camera, audio devices, and laptop are not included with this solution. See pages [4](#) and [5](#) for more information.

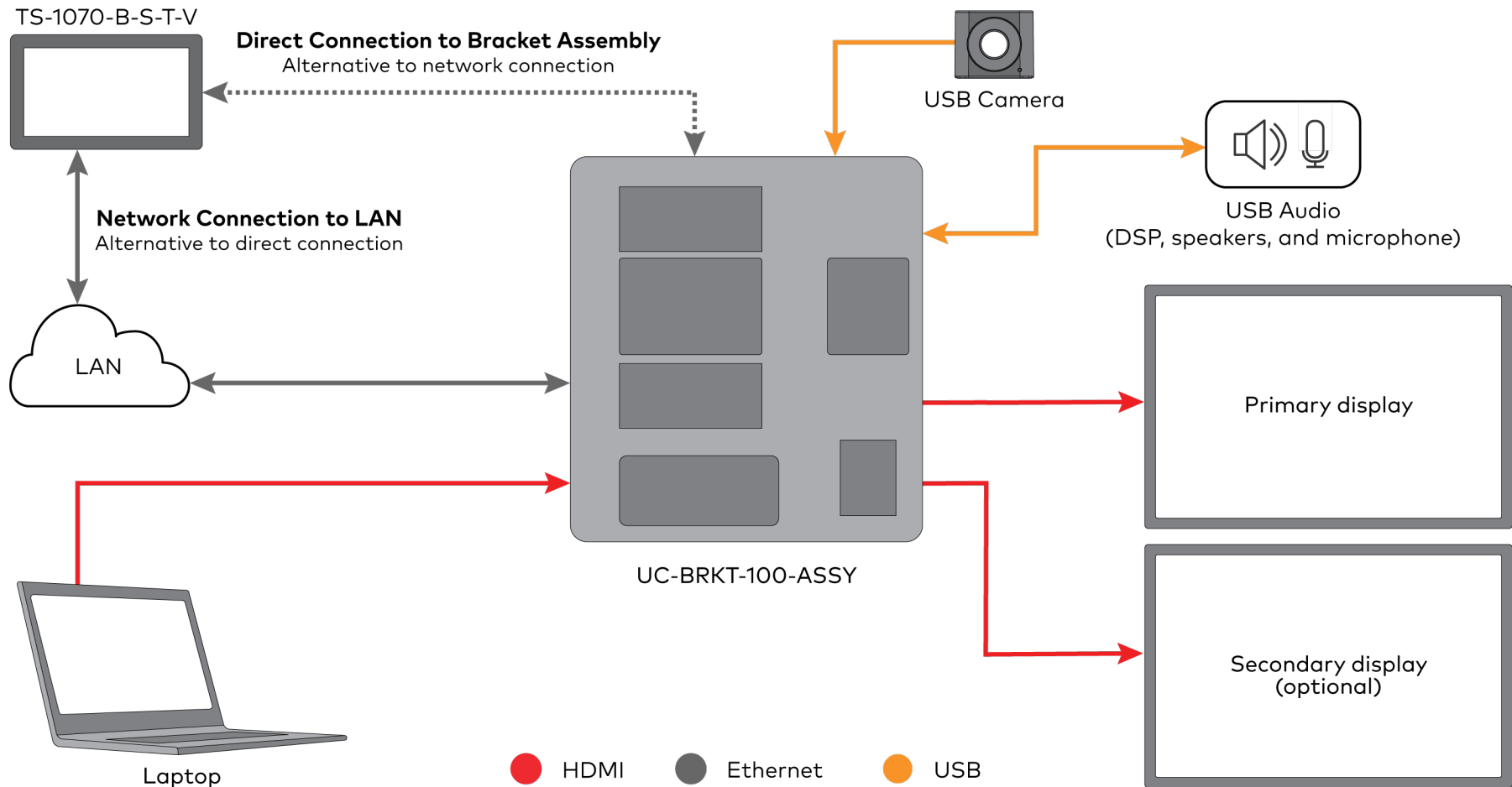

Crestron Flex UC Video Conference System Integrator Solution for Microsoft Teams® Rooms



Connect

1. Remove the connector covers prior to making UC-ENGINE connections on the UC-BRKT-100-ASSY bracket assembly.

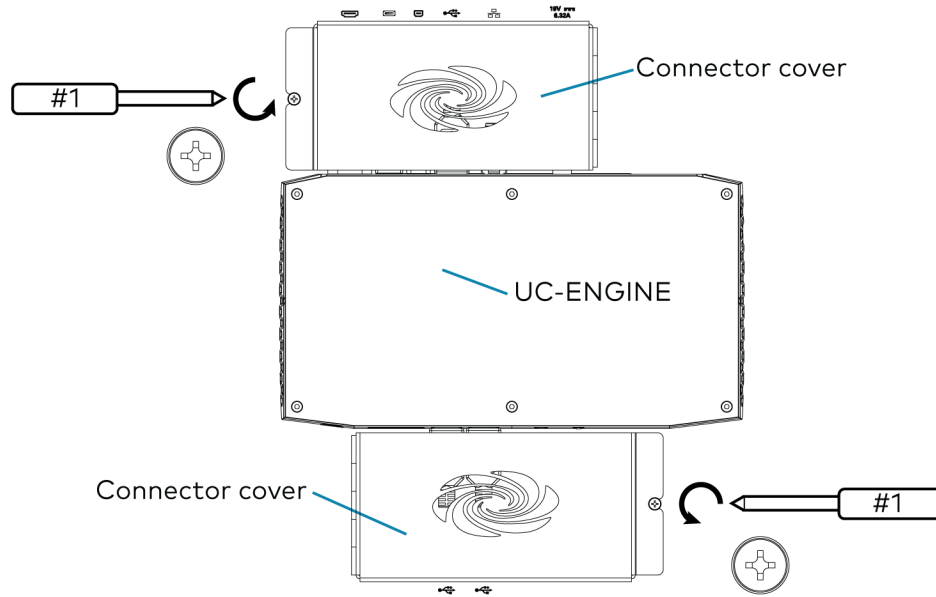

1. Make connections to the TS-1070-B-S-T-V touch screen and UC-BRKT-100-ASSY bracket assembly as shown in the following illustrations.

The TS-1070-B-S-T-V touch screen can communicate with the UC-ENGINE over a direct connection or a network connection.

Choose a direct connection to the UC-ENGINE for simple installation and setup, or a network connection if the TS-1070-B-S-T-V must be installed on the network and managed by the Crestron XiO Cloud™ service.

Crestron Flex UC Video Conference System Integrator Solution for Microsoft Teams® Rooms

Direct Connection

For simplified installation and configuration, use a direct Ethernet connection between the TS-1070-B-S-T-V touch screen's PWE-4803-RU PoE injector and the USB-to-RJ-45 Ethernet Adapter on the bottom of the UC-ENGINE.

NOTE: Direct Connection does not allow Crestron XiO Cloud management of the TS-1070-B-S-T-V. A network connection must be made as shown on the following page.

- **HDMI**
20 ft CBL-HD-20 HDMI cable
- **USB**
Audio
(DSP, speakers, and microphone)
- **Power**
- **Ethernet**
5 ft CAT5e cable
(supplied with PWE-4803RU)
7 ft CBL-CAT5E-7 cable (x 2)
20 ft DM-CBL-ULTRA-PC-20 cable

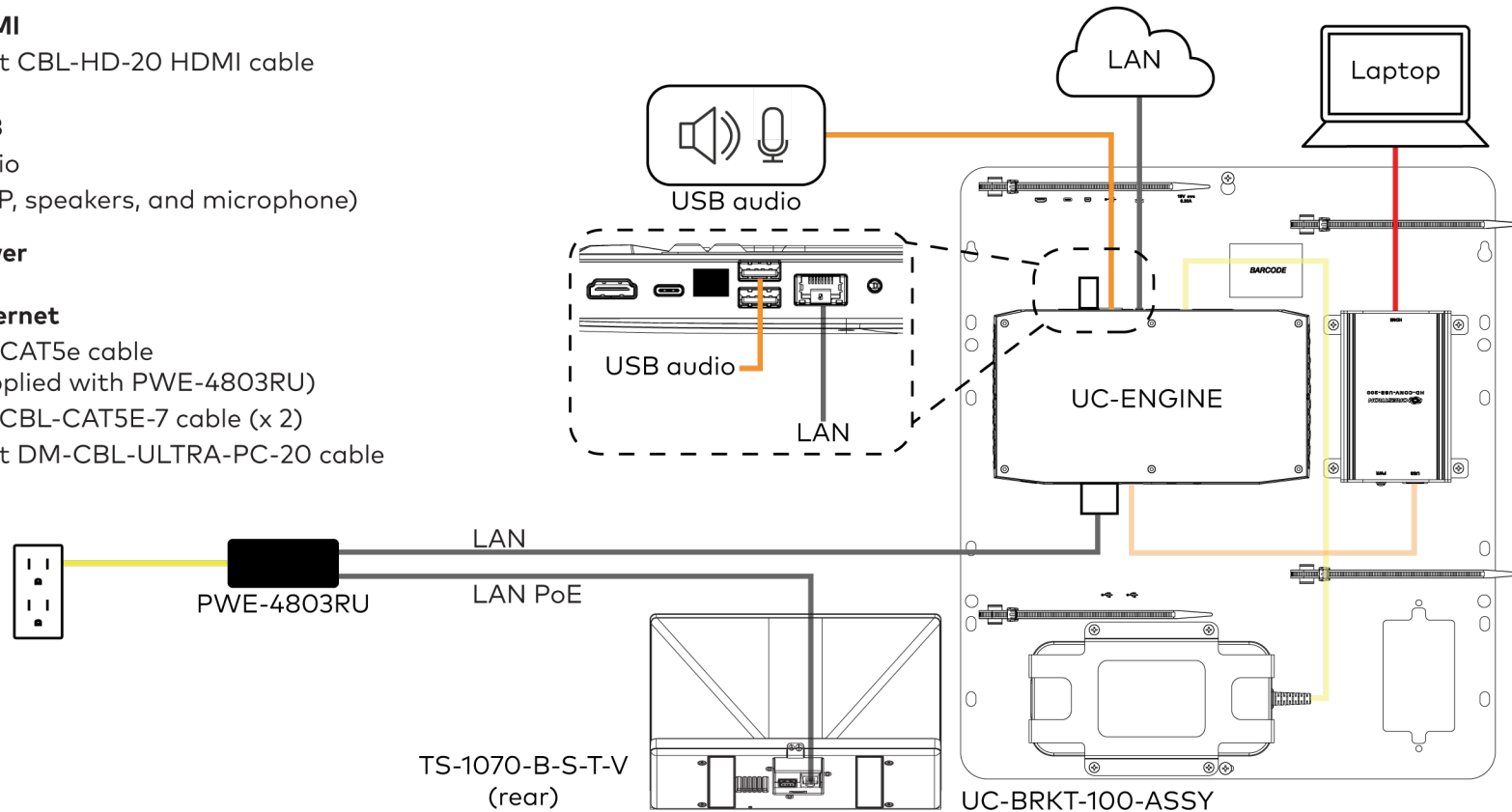

Crestron Flex UC Video Conference System Integrator Solution for Microsoft Teams® Rooms

Network Connection

Use the network connection for full network control of the TS-1070-B-S-T-V touch screen with the Crestron XiO Cloud service. The LAN port on the TS-1070-B-S-T-V touch screen's PoE injector connects to the UC-ENGINE over the VLAN.

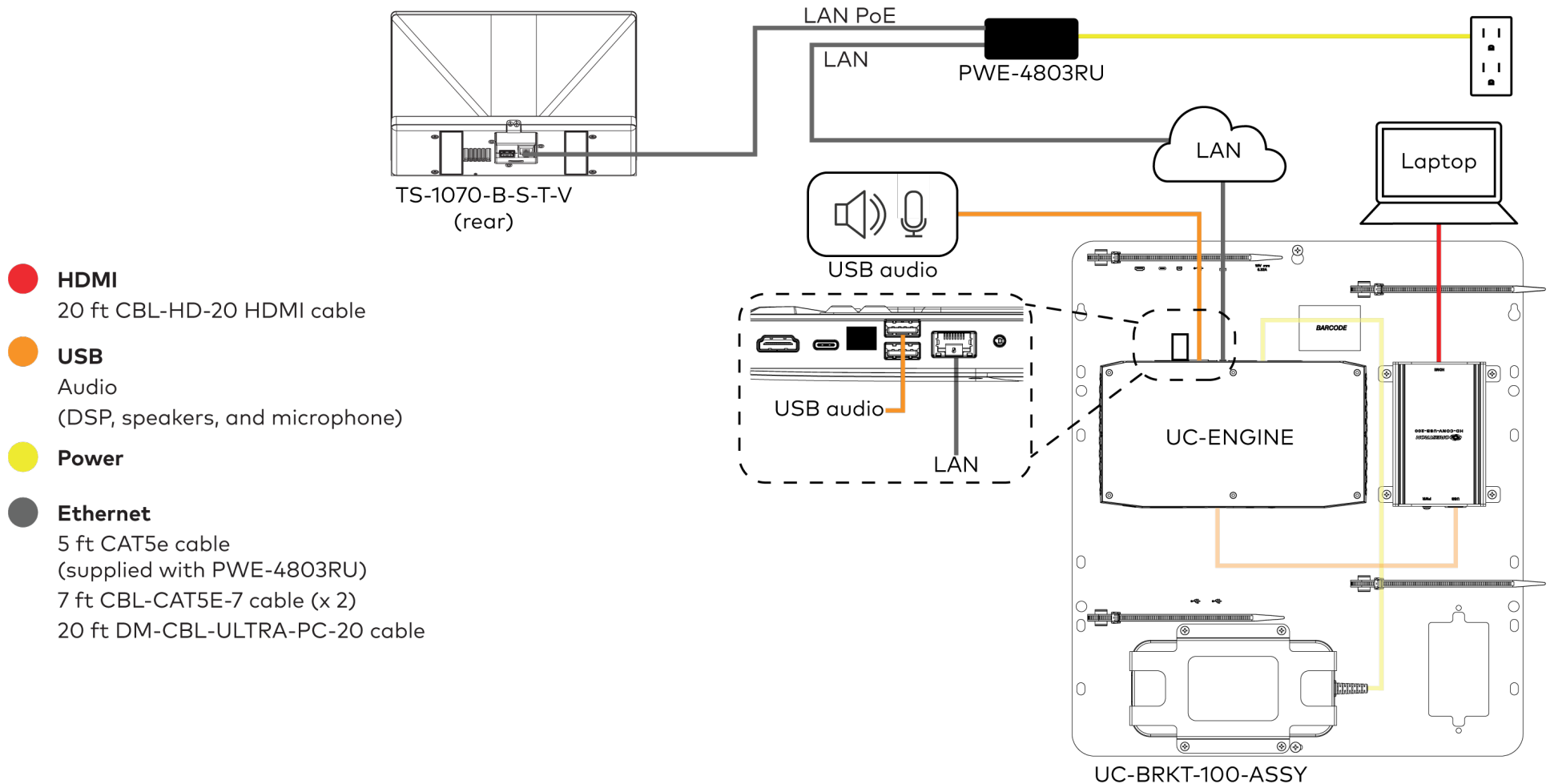

Crestron Flex UC Video Conference System Integrator Solution for Microsoft Teams® Rooms

3. Connect the display devices and camera to the UC-ENGINE as shown below.

- HDMI**
Primary: CBL-HD-THIN-HS-6 cable
Secondary: CBL-USBC-HD-9 cable
- USB**
USB camera
- Power**
Power cord
(supplied with UC-BRKT-100-ASSY)

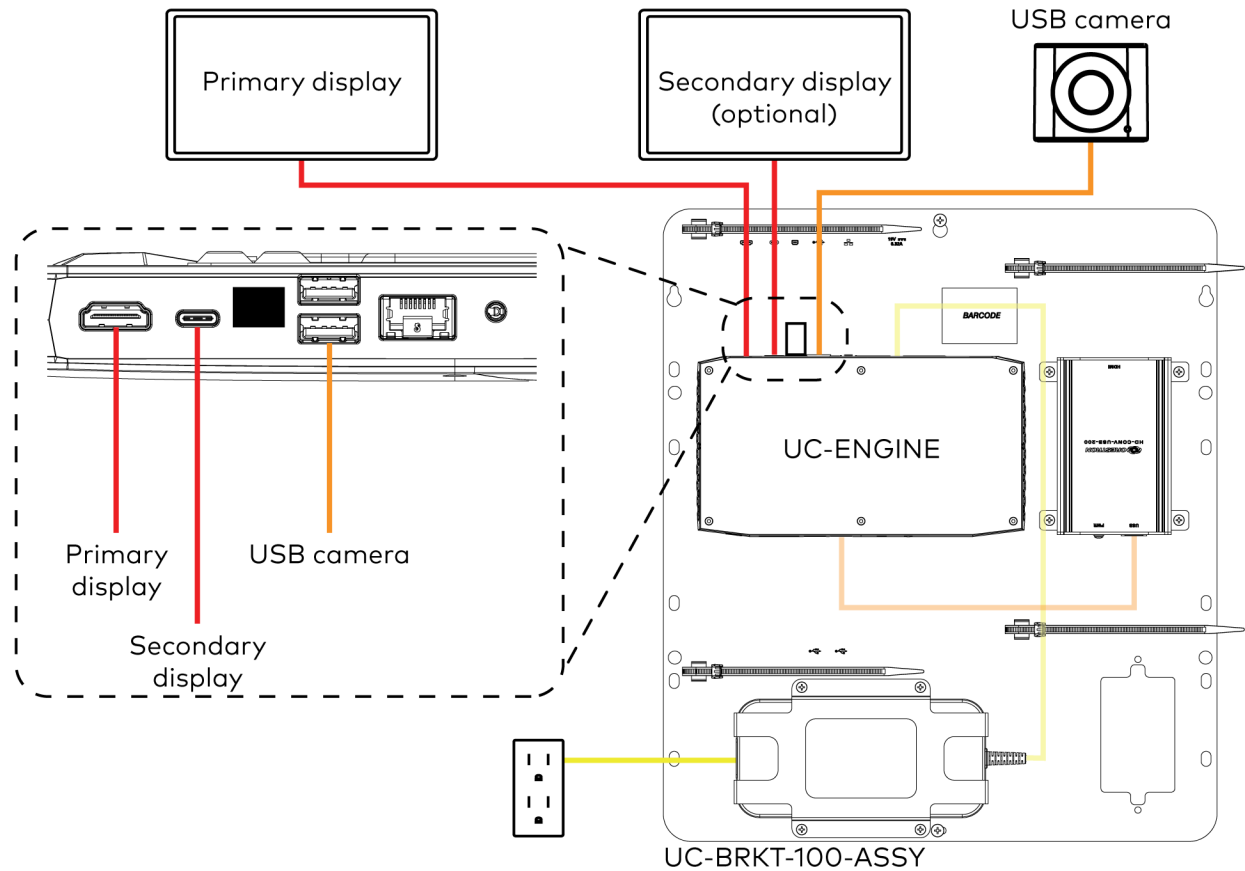

Crestron Flex UC Video Conference System Integrator Solution for Microsoft Teams® Rooms

- Bundle the cables with the integrated cable tie wraps. The cable tie wraps are reusable.

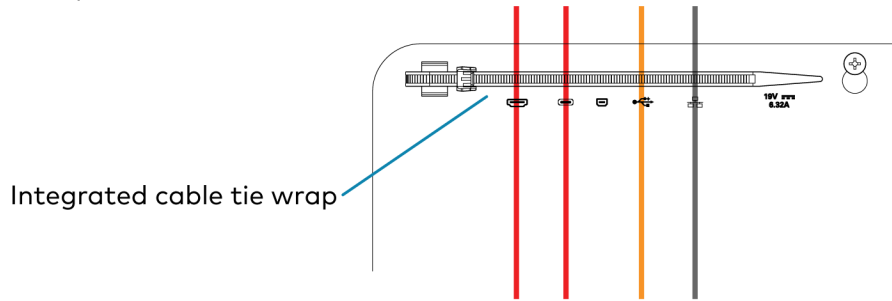

Complete the Installation

After completing UC-ENGINE connections, secure the connector covers using a #1 Phillips head screwdriver to replace the screws.

NOTE: For additional security, replace the screws with the spanner screws included with the bracket assembly. A 1/4 in. bit is also supplied with the bracket assembly to install the spanner screws.

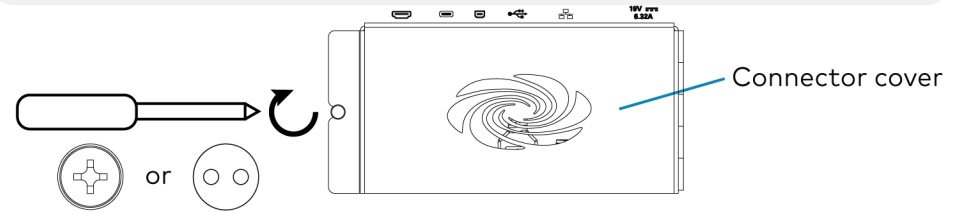

Crestron Flex UC Video Conference System Integrator Solution for Microsoft Teams® Rooms



Configure

Apply Power

Press the power button on the bottom of the UC-ENGINE and apply power to all of the other devices in the system.

Configure the Touch Screen

NOTE: If the TS-1070-B-S-T-V touch screen is directly connected to the UC-ENGINE via the PWE-4803-RU, perform steps 1 and 2 below, and skip to "Configure the System." Otherwise, continue below.

1. Tap **Touch Here to Enable a Specific Application** on the bottom of the TS-1070-B-S-T-V touch screen. A list of applications is displayed.
2. Tap **Teams Video**, and then tap **Confirm**. The TS-1070-B-S-T-V touch screen will reboot.
3. On a computer, open a web browser to the IP address of the TS-1070-B-S-T-V touch screen. Log in and navigate to **Settings > Applications**.

NOTES:

- The TS-1070-B-S-T-V touch screen (via the PW-4803RU) and computer must be on the same network switch and VLAN.
- A login with administrative rights for the TS-1070-B-S-T-V touch screen is required.

4. Enter the following information in the appropriate fields:

- **Teams Video PC Address:** Enter the IP address or hostname of the UC-ENGINE.

NOTE: The hostname is printed on a label affixed to the UC-ENGINE (mounted on the UC-BRKT-100-ASSY bracket assembly).

- **Teams Video PC Port:** By default, port number 49500 is used. If a different port number has been configured on the UC-ENGINE, enter that port number instead.
- **Teams Video Username:** Enter the login username for the UC-ENGINE. (The default username is "admin".)
- **Teams Video Password:** Enter the login password for the UC-ENGINE. (The default password is "sfb".)

5. Click **Save Changes**.

For more information, refer to the [TS-770 and TS-1070 Product Manual](#) (Doc. 8555).

Configure the System

Use the TS-1070-B-S-T-V and your Microsoft Teams or Skype account credentials to configure the UC-ENGINE. Refer to the [Crestron Flex UC Video Conference Systems Supplemental Guide](#) (Doc. 8360).

Crestron Flex UC Video Conference System Integrator Solution for Microsoft Teams® Rooms



Visit the Product Page

Scan the QR code to visit the product page.

UC-C160-T



www.crestron.com/model/6510684

Additional Information

Original Instructions

The U.S. English version of this document is the original instructions.
All other languages are a translation of the original instructions.

Crestron product development software is licensed to Crestron dealers and Crestron Service Providers (CSPs) under a limited nonexclusive, nontransferable Software Development Tools License Agreement. Crestron product operating system software is licensed to Crestron dealers, CSPs, and end-users under a separate End-User License Agreement. Both of these Agreements can be found on the Crestron website at www.crestron.com/legal/software_license_agreement.

The product warranty can be found at www.crestron.com/warranty.

The specific patents that cover Crestron products are listed at www.crestron.com/legal/patents.

Certain Crestron products contain open source software. For specific information, visit www.crestron.com/opensource.

Crestron, the Crestron logo, DigitalMedia, and Crestron XiO Cloud are either trademarks or registered trademarks of Crestron Electronics, Inc. in the United States and/or other countries. HDMI and the HDMI logo are either trademarks or registered trademarks of HDMI Licensing LLC in the United States and/or other countries. Microsoft 365, Microsoft Exchange Server, Microsoft Teams, and Skype are either trademarks or registered trademarks of Microsoft Corporation in the United States and/or other countries. Other trademarks, registered trademarks, and trade names may be used in this document to refer to either the entities claiming the marks and names or their products. Crestron disclaims any proprietary interest in the marks and names of others. Crestron is not responsible for errors in typography or photography.

HDMI

©2021 Crestron Electronics, Inc.

Doc ID 8395F

09/20/21