



ASHRAE 2019 Zūm[®] Wireless Solutions Education Applications

Crestron Electronics, Inc.

Original Instructions

The U.S. English version of this document is the original instructions.
All other languages are a translation of the original instructions.

Crestron product development software is licensed to Crestron dealers and Crestron Service Providers (CSPs) under a limited nonexclusive, nontransferable Software Development Tools License Agreement. Crestron product operating system software is licensed to Crestron dealers, CSPs, and end-users under a separate End-User License Agreement. Both of these Agreements can be found on the Crestron website at www.crestron.com/legal/software_license_agreement.

The product warranty can be found at www.crestron.com/warranty.

The specific patents that cover Crestron products are listed at www.crestron.com/legal/patents.

Certain Crestron products contain open source software. For specific information, visit www.crestron.com/opensource.





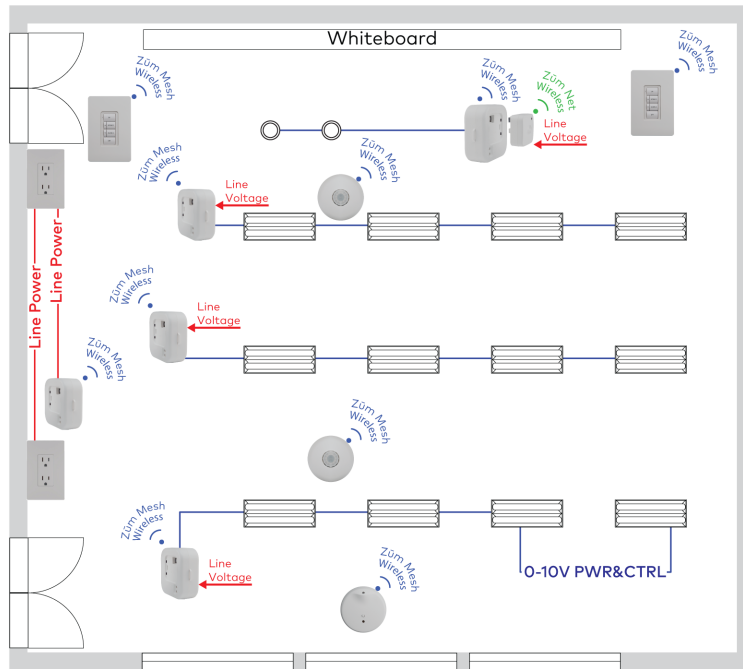

Crestron, the Crestron logo, and Zūm are either trademarks or registered trademarks of Crestron Electronics, Inc. in the United States and/or other countries. DALI is either a trademark or registered trademark of IEEE Industry Standards and Technology Organization, Inc. in the United States and/or other countries. Other trademarks, registered trademarks, and trade names may be used in this document to refer to either the entities claiming the marks and names or their products. Crestron disclaims any proprietary interest in the marks and names of others. Crestron is not responsible for errors in typography or photography.

©2021 Crestron Electronics, Inc.

Zūm® Wireless: 0 - 10V Drivers



Bill of Materials

Item	Product	Qty
	ZUMMESH-JBOX-20A-PLUG Zūm Mesh, Plug, 100-240V, 20A	1
	ZUMMESH-JBOX-16A-LV Zūm Mesh, Dimmer, 0-10V, 16A	3
	ZUMMESH-JBOX-16A-LV + NETBRIDGE Zūm Mesh, Dimmer, 0-10V, 16A + Network Bridge	1
	ZUMMESH-KP10CBATT Zūm Mesh, Battery-Powered Keypad	2
	ZUMMESH-OL-PHOTOCELL-BATT Zūm Mesh, Battery-Powered Daylight Sensor	1
	ZUMMESH-PIR-VACANCY-BATT Zūm Mesh, Battery-Powered Vacancy Sensor	2
	Receptacle	2

Code

- Manual Control Device**
9.4.1.1(a)
Physical control interface for occupant

- Vacancy Sensor**
9.4.1.1(b), 9.4.1.1(h)
Motion detection: Manual On, Automatic Off





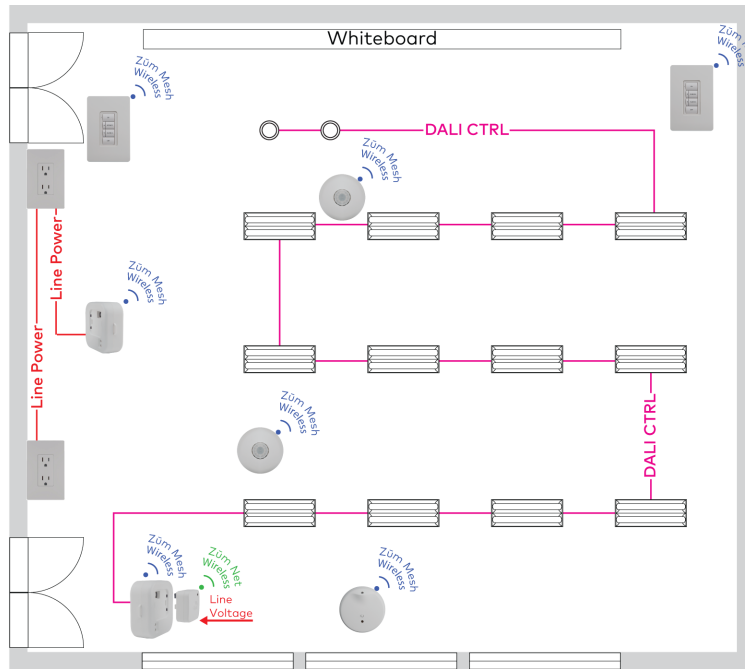

- Daylight Response**
9.4.1.1(e), 9.4.1.4(a)
Light level control based on daylighting

- Controlled Receptacles**
C405.2.4
Control of receptacle power

Zūm® Wireless: DALI® Drivers



Bill of Materials

Item	Product	Qty
	ZUMMESH-JBOX-20A-PLUG Zūm Mesh, Plug, 100-240V, 20A	1
	ZUMMESH-JBOX-16A-LV Zūm Mesh, Dimmer, 0-10V, 16A	2
	ZUMMESH-JBOX-DALI + NETBRIDGE Zūm Mesh, DALI, + Network Bridge	1
	ZUMMESH-OL-PHOTOCELL-BATT Zūm Mesh, Battery-Powered Daylight Sensor	1
	ZUMMESH-PIR-VACANCY-BATT Zūm Mesh, Battery-Powered Vacancy Sensor	2
	Receptacle	2



Code

- Manual Control Device**
9.4.1.1(a)
Physical control interface for occupant
- Vacancy Sensor**
9.4.1.1(b), 9.4.1.1(h)
Motion detection: Manual On, Automatic Off
- Daylight Response**
9.4.1.1(e), 9.4.1.4(a)
Light level control based on daylighting
- Controlled Receptacles**
8.4.2(a), 8.4.2(b), 8.4.2(c)
Control of receptacle power

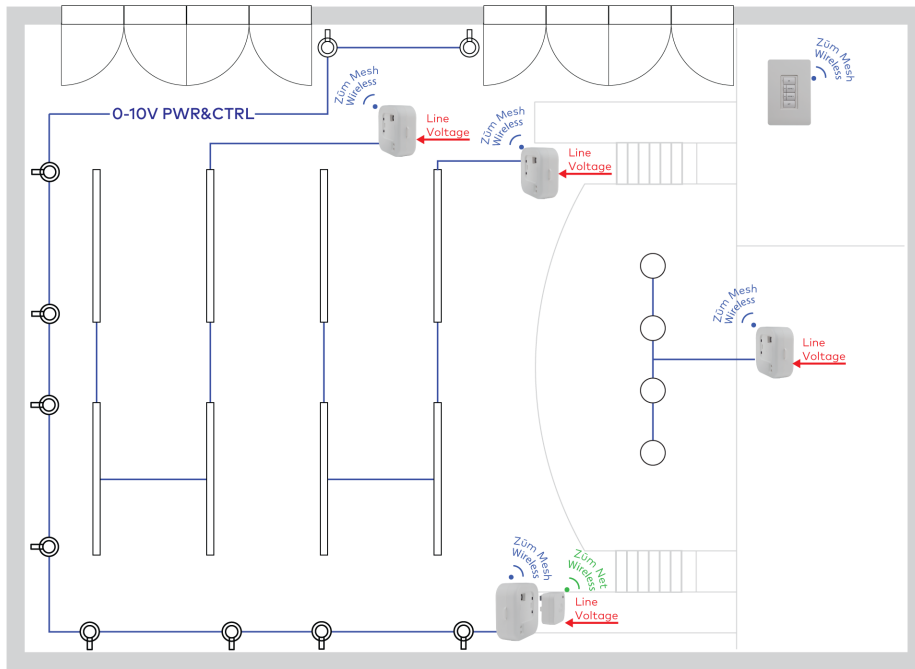
Zūm® Wireless: 0 - 10V Drivers



Bill of Materials

Item	Product	Qty
	ZUMMESH-JBOX-16A-LV Zūm Mesh, Dimmer, 0-10V, 16A	2
	ZUMMESH-JBOX-16A-LV + NETBRIDGE Zūm Mesh, Dimmer, 0-10V, 16A + Network Bridge	1
	ZUMMESH-KP10CBATT Zūm Mesh, Battery-Powered Keypad	1

Code

- Manual Control Device**
9.4.1.1(a)
Physical control interface for occupant



- Programmable Timeclock**
9.4.1.1(c), 9.4.1.1(i)
Programmed time Auto On, Auto Off

- Daylight Response**
9.4.1.1(e), 9.4.1.4(a)
Light level control based on daylighting

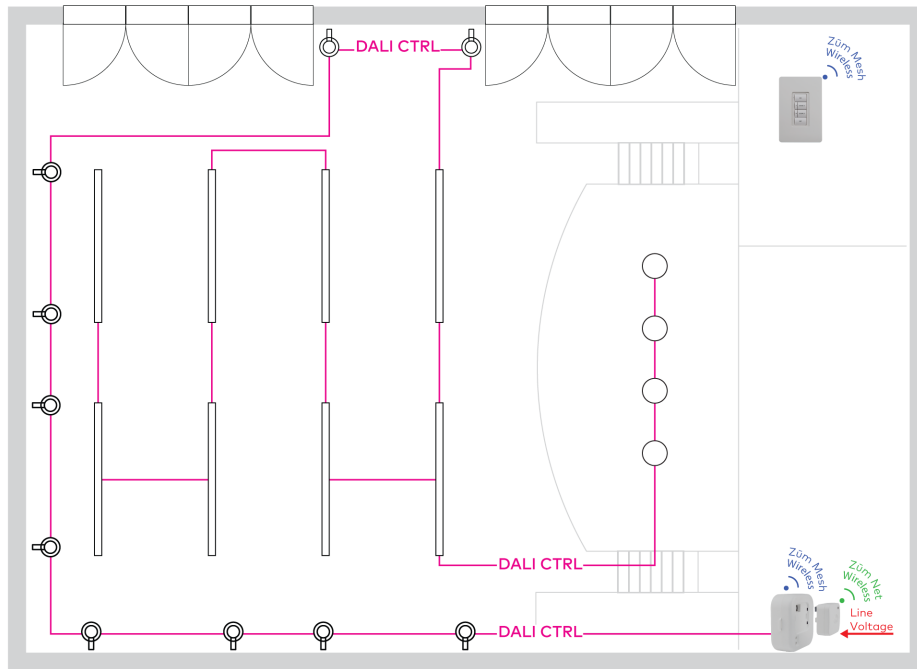
Zūm® Wireless: DALI® Drivers



Bill of Materials

Item	Product	Qty
	ZUMMESH-JBOX-DALI + NETBRIDGE Zūm Mesh, DALI, + Network Bridge	1
	ZUMMESH-KP10CBATT Zūm Mesh, Battery-Powered Keypad	1



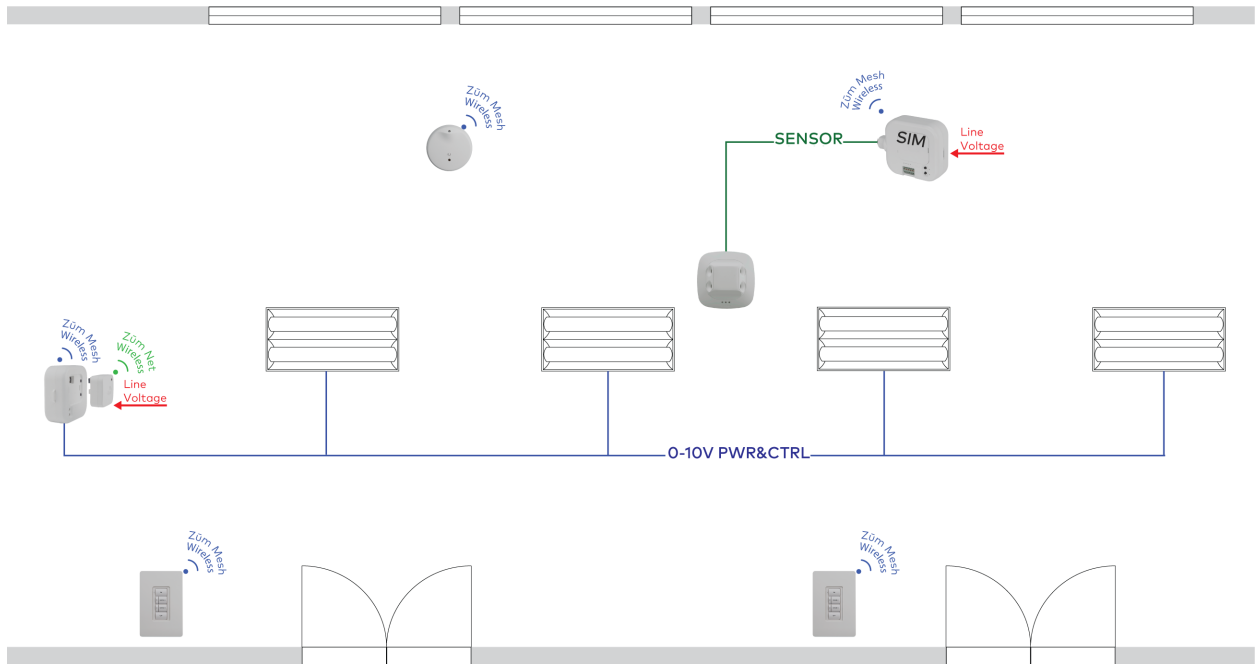

Code

- Manual Control Device**
9.4.1.1(a)
Physical control interface for occupant
- Programmable Timeclock**
9.4.1.1(c), 9.4.1.1(i)
Programmed time Auto On, Auto Off
- Daylight Response**
9.4.1.1(e), 9.4.1.4(a)
Light level control based on daylighting

Zūm® Wireless: 0 - 10V Drivers



Bill of Materials

Item	Product	Qty
	ZUMMESH-JBOX-16A-LV + NETBRIDGE Zūm Mesh, Dimmer, 0-10V, 16A + Network Bridge	1
	ZUMMESH-JBOX-SIM Zūm Mesh JBox Sensor	1
	ZUMMESH-KP10CBATT Zūm Mesh, Battery-Powered Keypad	2
	ZUMMESH-OL-PHOTOCELL-BATT Zūm Mesh, Battery-Powered Daylight Sensor	1
	GLA-US-HALLWAY-COM1-24 Occupancy Sensor	1

Code

- Manual Control Device**
9.4.1.1(a)
Physical control interface for occupant



- Occupancy Sensor**
9.4.1.1(c), 9.4.1.1(h)
Motion detection: Automatic On, Automatic Off

- Daylight Response**
9.4.1.1(e), 9.4.1.4(a)
Light level control based on daylighting

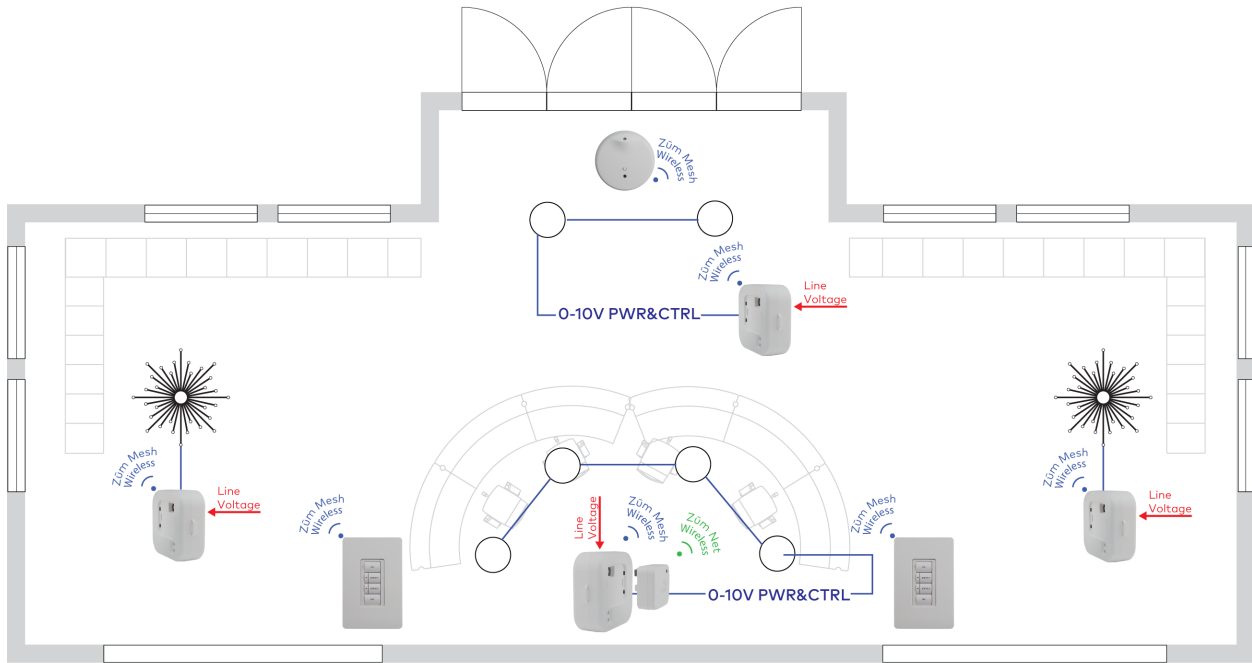
Zūm® Wireless: 0 - 10V Drivers



Bill of Materials

Item	Product	Qty
	ZUMMESH-JBOX-16A-LV Zūm Mesh, Dimmer, 0-10V, 16A	1
	ZUMMESH-KP10CBATT Zūm Mesh, Battery-Powered Keypad	2
	ZUMMESH-OL-PHOTOCELL-BATT Zūm Mesh, Battery-Powered Daylight Sensor	1

Code

- Manual Control Device**
9.4.1.1(a)
Physical control interface for occupant



- Programmable Timeclock**
9.4.1.1(c), 9.4.1.1(i)
Programmed time Auto On, Auto Off

- Daylight Response**
9.4.1.1(e), 9.4.1.4(a)
Light level control based on daylighting

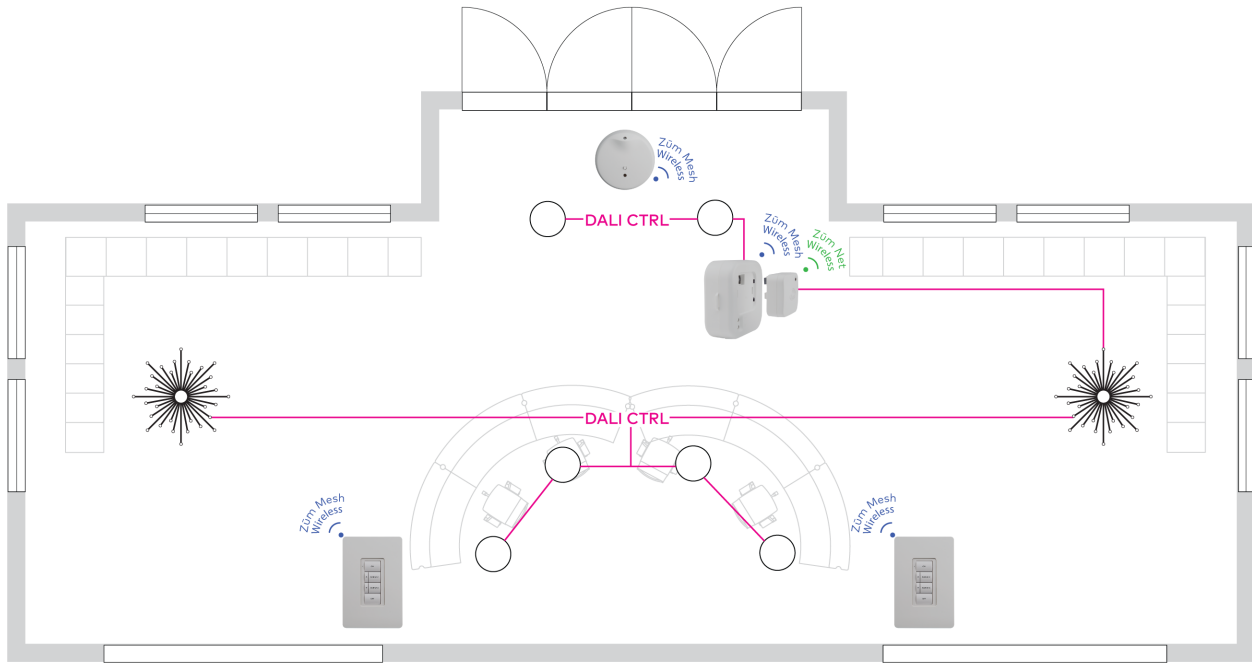
Zūm® Wireless: DALI® Drivers



Bill of Materials

Item	Product	Qty
	ZUMMESH-JBOX-DALI + NETBRIDGE Zūm Mesh, DALI, + Network Bridge	1
	ZUMMESH-KP10CBATT Zūm Mesh, Battery-Powered Keypad	2
	ZUMMESH-OL-PHOTOCELL-BATT Zūm Mesh, Battery-Powered Daylight Sensor	1

Code

- Manual Control Device**
9.4.1.1(a)
Physical control interface for occupant





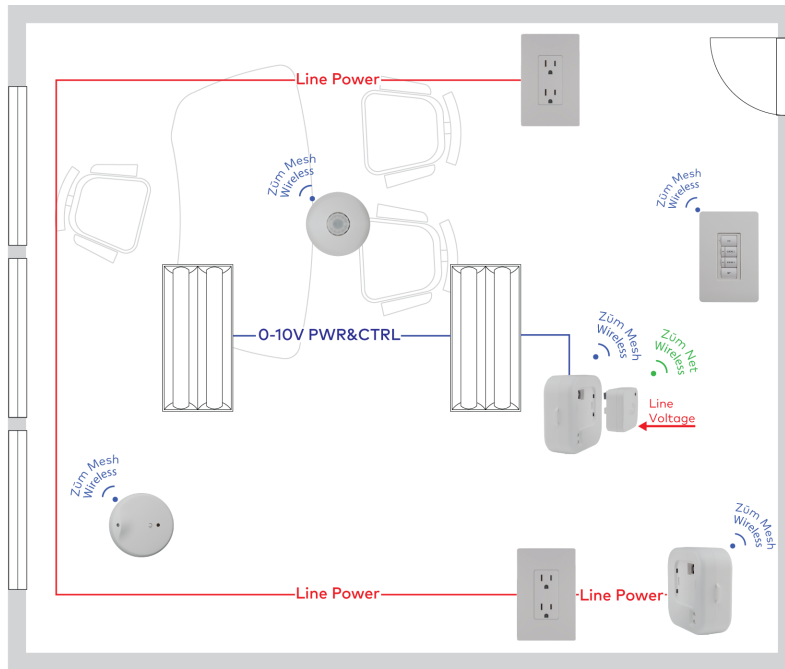

- Programmable Timeclock**
9.4.1.1(c), 9.4.1.1(i)
Programmed time Auto On, Auto Off

- Daylight Response**
9.4.1.1(e), 9.4.1.4(a)
Light level control based on daylighting

Zūm® Wireless: 0 - 10V Drivers



Bill of Materials

Item	Product	Qty
	ZUMMESH-JBOX-20A-PLUG Zūm Mesh, Plug, 100-240V, 20A	1
	ZUMMESH-JBOX-16A-LV + NETBRIDGE Zūm Mesh, Dimmer, 0-10V, 16A + Network Bridge	1
	ZUMMESH-KP10CBATT Zūm Mesh, Battery-Powered Keypad	1
	ZUMMESH-OL-PHOTOCELL-BATT Zūm Mesh, Battery-Powered Daylight Sensor	1
	ZUMMESH-PIR-VACANCY-BATT Zūm Mesh, Battery-Powered Vacancy Sensor	1
	Receptacle	2



Code

- Manual Control Device**
9.4.1.1(a)
Physical control interface for occupant
- Vacancy Sensor**
9.4.1.1(b), 9.4.1.1(h)
Motion detection: Manual On, Automatic Off
- Daylight Response**
9.4.1.1(e), 9.4.1.4(a)
Light level control based on daylighting
- Controlled Receptacles**
8.4.2(a), 8.4.2(b), 8.4.2(c)
Control of receptacle power

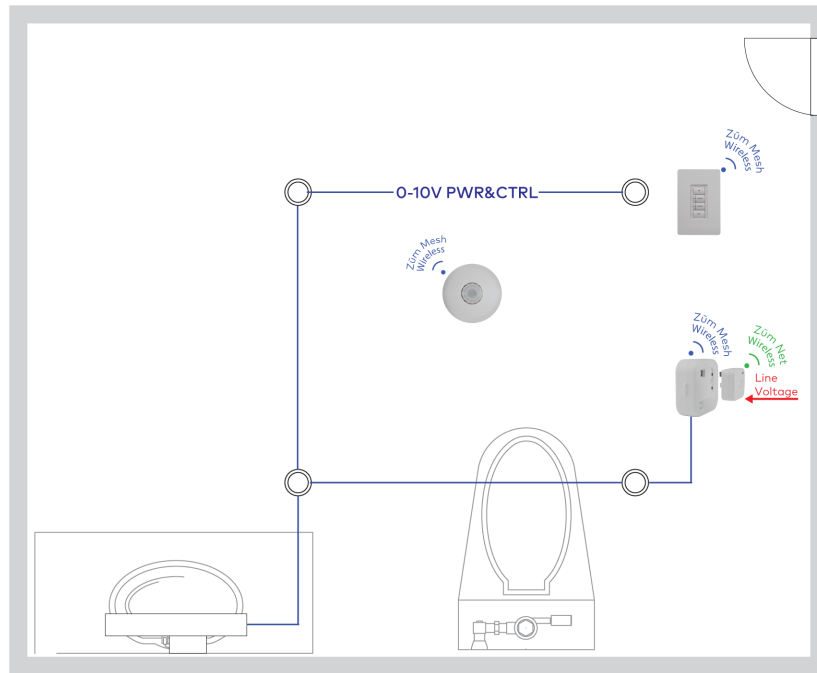
Zūm® Wireless: 0 - 10V Drivers



Bill of Materials

Item	Product	Qty
	ZUMMESH-JBOX-16A-LV + NETBRIDGE Zūm Mesh, Dimmer, 0-10V, 16A + Network Bridge	1
	ZUMMESH-PIR-OCCUPANCY-BATT Zūm Mesh, Battery-Powered Sensor	1

Code



Occupancy Sensor
9.4.1.1(c), 9.4.1.1(h)
Motion detection: Automatic On, Automatic Off

Daylight Response
9.4.1.1(e), 9.4.1.4(a)
Light level control based on daylighting

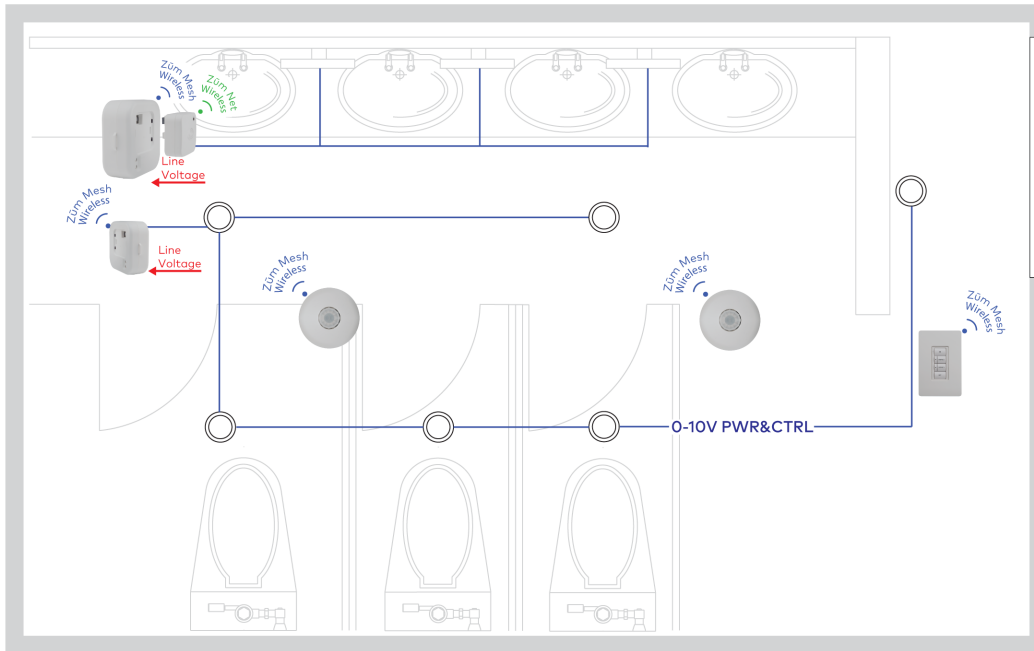
Zūm® Wireless: 0 - 10V Drivers



Bill of Materials

Item	Product	Qty
	ZUMMESH-JBOX-16A-LV Zūm Mesh, Dimmer, 0-10V, 16A	1
	ZUMMESH-JBOX-16A-LV + NETBRIDGE Zūm Mesh, Dimmer, 0-10V, 16A + Network Bridge	1
	ZUMMESH-PIR-OCCUPANCY-BATT Zūm Mesh, Battery-Powered Sensor	2

Code



Occupancy Sensor
9.4.1.1(c), 9.4.1.1(h)
Motion detection: Automatic On, Automatic Off

Daylight Response
9.4.1.1(e), 9.4.1.4(a)
Light level control based on daylighting

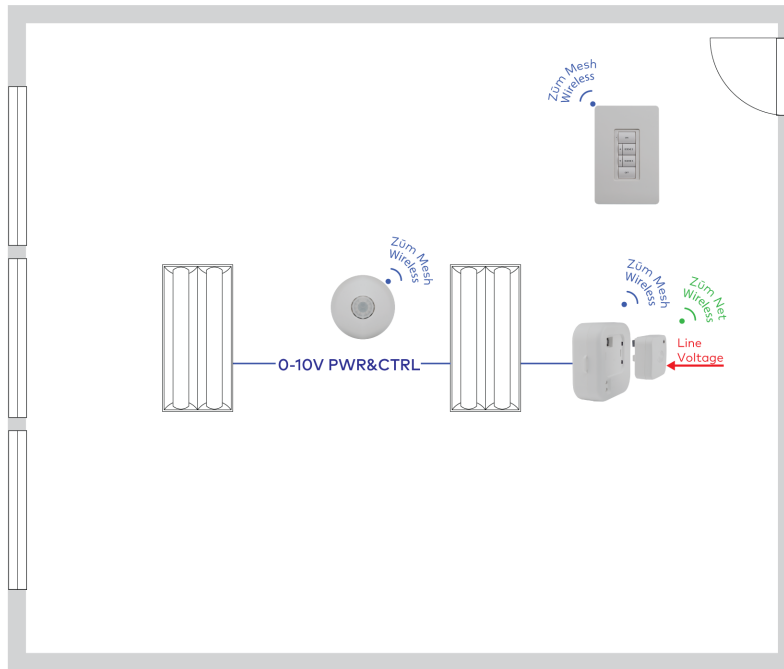
Zūm® Wireless: 0 - 10V Drivers



Bill of Materials

Item	Product	Qty
	ZUMMESH-JBOX-16A-LV + NETBRIDGE Zūm Mesh, Dimmer, 0-10V, 16A + Network Bridge	1
	ZUMMESH-KP10CBATT Zūm Mesh, Battery-Powered Keypad	1
	ZUMMESH-PIR-VACANCY-BATT Zūm Mesh, Battery-Powered Vacancy Sensor	1

Code

Manual Control Device

9.4.1.1(a)
Physical control interface for occupant

Vacancy Sensor

9.4.1.1(b), 9.4.1.1(h)
Motion detection: Manual On, Automatic Off

Daylight Response

9.4.1.1(e), 9.4.1.4(a)
Light level control based on daylighting

Contact Info

Name

Company

Address 1

Address 2

City, State, Zip

Phone

Email

Website

Project Notes

Square Footage	Cost/Sq. Ft.