



IECC 2018 Zūm[®] Wireless Solutions Education Applications

Crestron Electronics, Inc.

Original Instructions

The U.S. English version of this document is the original instructions.
All other languages are a translation of the original instructions.

Crestron product development software is licensed to Crestron dealers and Crestron Service Providers (CSPs) under a limited nonexclusive, nontransferable Software Development Tools License Agreement. Crestron product operating system software is licensed to Crestron dealers, CSPs, and end-users under a separate End-User License Agreement. Both of these Agreements can be found on the Crestron website at www.crestron.com/legal/software_license_agreement.

The product warranty can be found at www.crestron.com/warranty.

The specific patents that cover Crestron products are listed at www.crestron.com/legal/patents.

Certain Crestron products contain open source software. For specific information, visit www.crestron.com/opensource.



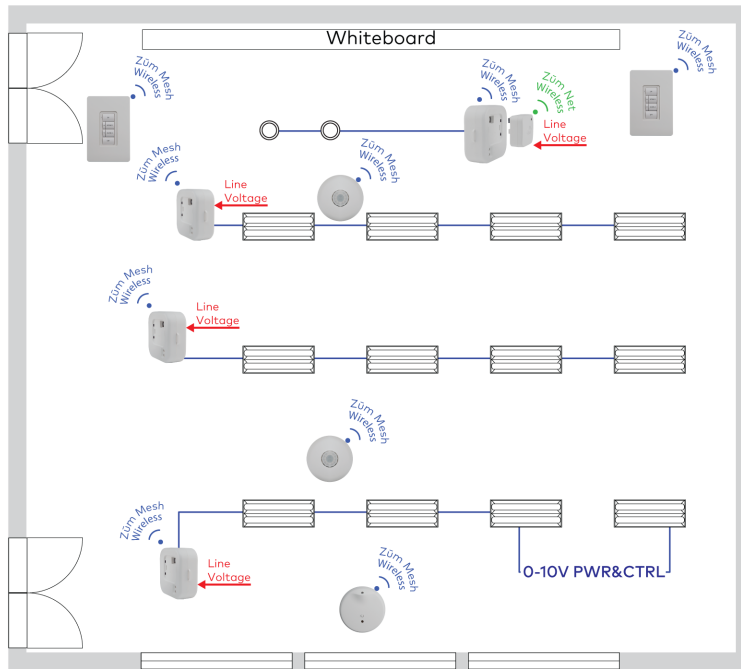

Crestron, the Crestron logo, and Zūm are either trademarks or registered trademarks of Crestron Electronics, Inc. in the United States and/or other countries. DALI is either a trademark or registered trademark of IEEE Industry Standards and Technology Organization, Inc. in the United States and/or other countries. Other trademarks, registered trademarks, and trade names may be used in this document to refer to either the entities claiming the marks and names or their products. Crestron disclaims any proprietary interest in the marks and names of others. Crestron is not responsible for errors in typography or photography.

©2021 Crestron Electronics, Inc.

Zūm® Wireless: 0 - 10V Drivers



Bill of Materials

Item	Product	Qty
	ZUMMESH-JBOX-16A-LV Zūm Mesh, Dimmer, 0-10V, 16A	3
	ZUMMESH-JBOX-16A-LV + NETBRIDGE Zūm Mesh, Dimmer, 0-10V, 16A + Network Bridge	1
	ZUMMESH-KP10CBATT Zūm Mesh, Battery-Powered Keypad	2
	ZUMMESH-PIR-OCUPANCY-BATT Zūm Mesh, Battery-Powered Sensor	2
	ZUMMESH-OL-PHOTOCELL-BATT Zūm Mesh, Battery-Powered Daylight Sensor	1

Code

- Manual Control Device**
C405.2.5, C405.2.2.2
Physical control interface for occupant

- Vacancy Sensor Manual On**
C405.2.1.1
Physical control interface for occupant, Auto Off during vacancy



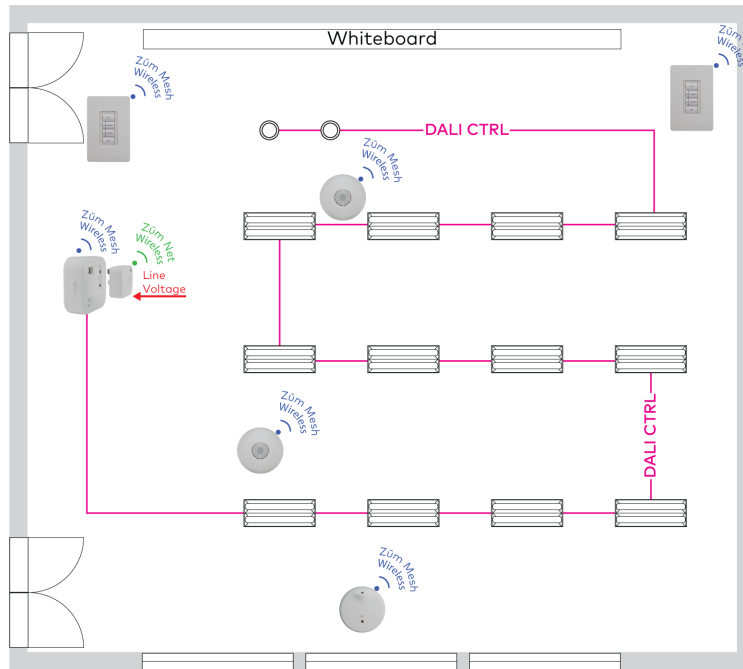

- Occupancy Sensor Full Off**
C405.2.1
Auto Off during vacancy

- Daylight Response**
C405.2, C405.2.61
Exception C405.2.3.1
Adjust lights based on available daylight

Zūm® Wireless: DALI® Drivers



Bill of Materials

Item	Product	Qty
	ZUMMESH-JBOX-DALI + NETBRIDGE Zūm Mesh, DALI, + Network Bridge	1
	ZUMMESH-KP10CBATT Zūm Mesh, Battery-Powered Keypad	2
	ZUMMESH-PIR-OCCUPANCY-BATT Zūm Mesh, Battery-Powered Sensor	2
	ZUMMESH-OL-PHOTOCELL-BATT Zūm Mesh, Battery-Powered Daylight Sensor	1

Code

- Manual Control Device**
C405.2.5, C405.2.2.2
Physical control interface for occupant

- Vacancy Sensor Manual On**
C405.2.1.1
Physical control interface for occupant, Auto Off during vacancy



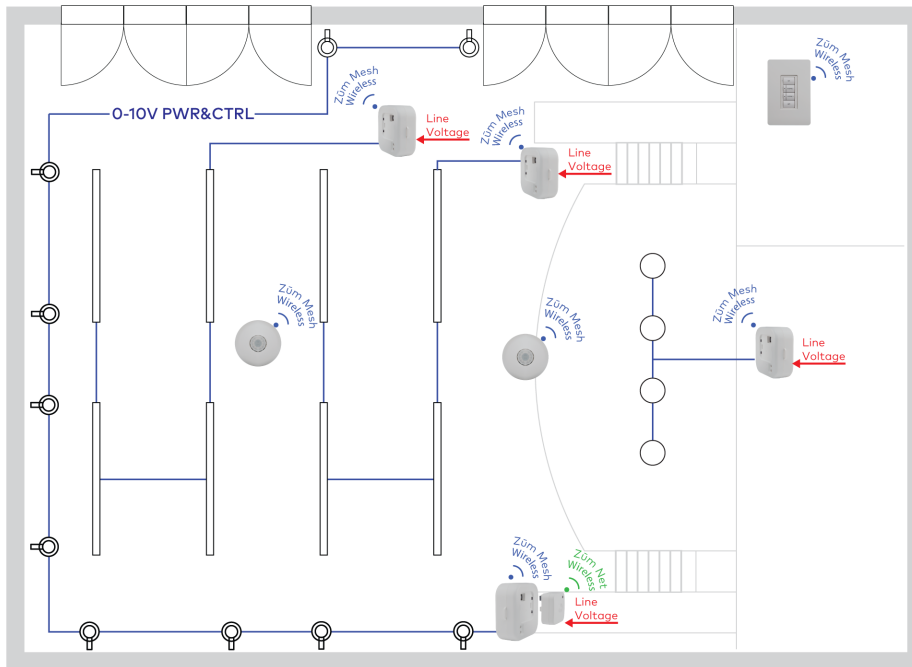

- Occupancy Sensor Full Off**
C405.2.1
Auto Off during vacancy

- Daylight Response**
C405.2, C405.2.61
Exception C405.2.3.1
Adjust lights based on available daylight

Zūm® Wireless: 0 - 10V Drivers



Bill of Materials

Item	Product	Qty
	ZUMMESH-JBOX-16A-LV Zūm Mesh, Dimmer, 0-10V, 16A	3
	ZUMMESH-JBOX-16A-LV + NETBRIDGE Zūm Mesh, Dimmer, 0-10V, 16A + Network Bridge	1
	ZUMMESH-KP10CBATT Zūm Mesh, Battery-Powered Keypad	1
	ZUMMESH-PIR-OCCUPANCY-BATT Zūm Mesh, Battery-Powered Sensor	2



Code

- Manual Control Device**
C405.2.5, C405.2.2.2
Physical control interface for occupant
- Occupancy Sensor Partial On**
C405.2.1.1
Partial On during occupancy
- Occupancy Sensor Full Off**
C405.2.1
Auto Off during vacancy
- Daylight Response**
C405.2, C405.2.61
Exception C405.2.3.1
Adjust lights based on available daylight

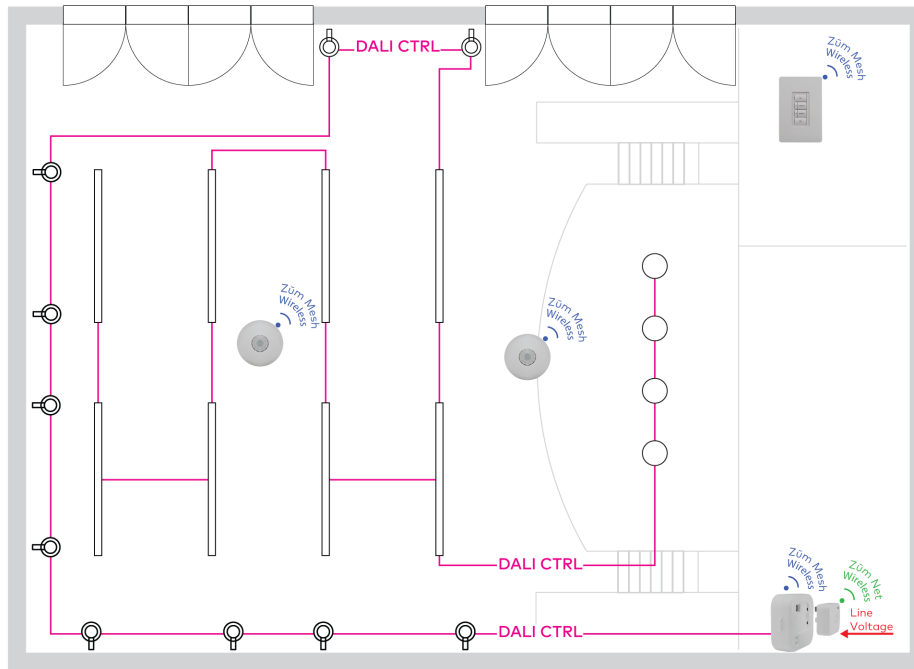
Zūm® Wireless: DALI® Drivers



Bill of Materials

Item	Product	Qty
	ZUMMESH-JBOX-DALI + NETBRIDGE Zūm Mesh, DALI, + Network Bridge	1
	ZUMMESH-KP10CBATT Zūm Mesh, Battery-Powered Keypad	1
	ZUMMESH-PIR-OCCUPANCY-BATT Zūm Mesh, Battery-Powered Sensor	2

Code

- Manual Control Device**
C405.2.5, C405.2.2.2
Physical control interface for occupant

- Occupancy Sensor Partial On**
C405.2.1.1
Partial On during occupancy

- Occupancy Sensor Full Off**
C405.2.1
Auto Off during vacancy



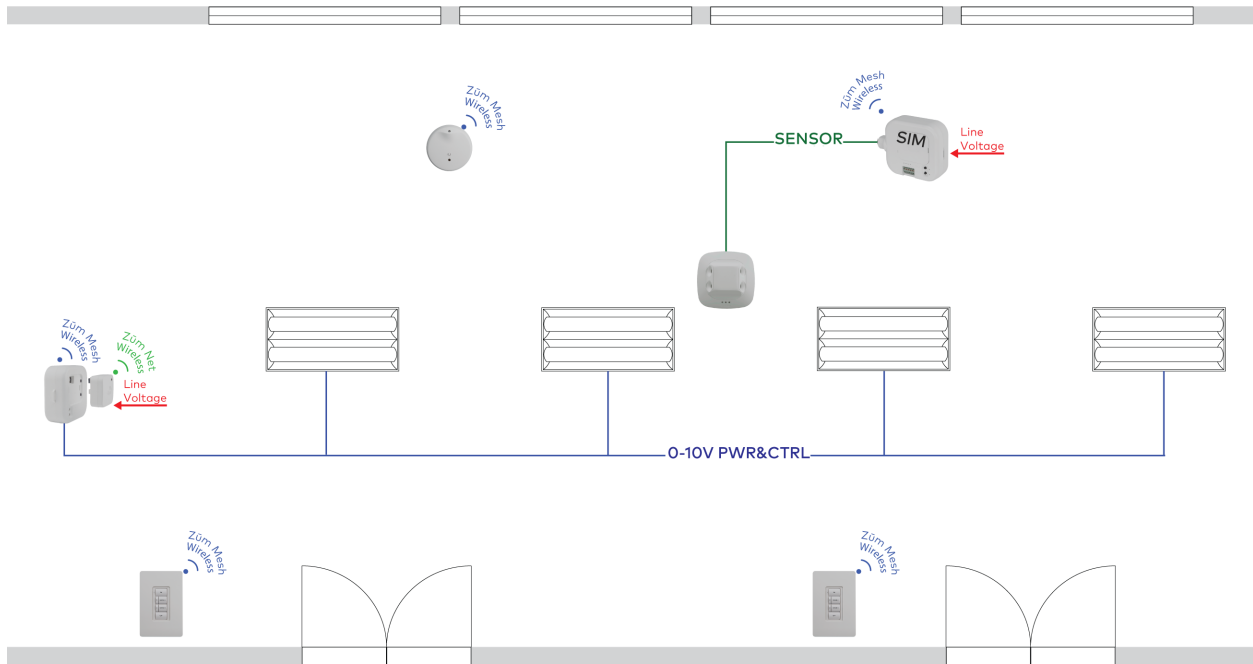

- Occupancy Sensor Partial Off**
C405.2.1
Partial Off during vacancy

- Daylight Response**
C405.2, C405.2.61
Exception C405.2.3.1
Adjust lights based on available daylight

Zūm® Wireless: 0 - 10V Drivers



Bill of Materials

Item	Product	Qty
	ZUMMESH-JBOX-16A-LV + NETBRIDGE Zūm Mesh, Dimmer, 0-10V, 16A + Network Bridge	1
	ZUMMESH-JBOX-SIM Zūm Mesh JBox Sensor	1
	ZUMMESH-KP10CBATT Zūm Mesh, Battery-Powered Keypad	2
	ZUMMESH-OL-PHOTOCELL-BATT Zūm Mesh, Battery-Powered Daylight Sensor	1
	GLA-US-HALLWAY-COM1-24 Occupancy Sensor	1





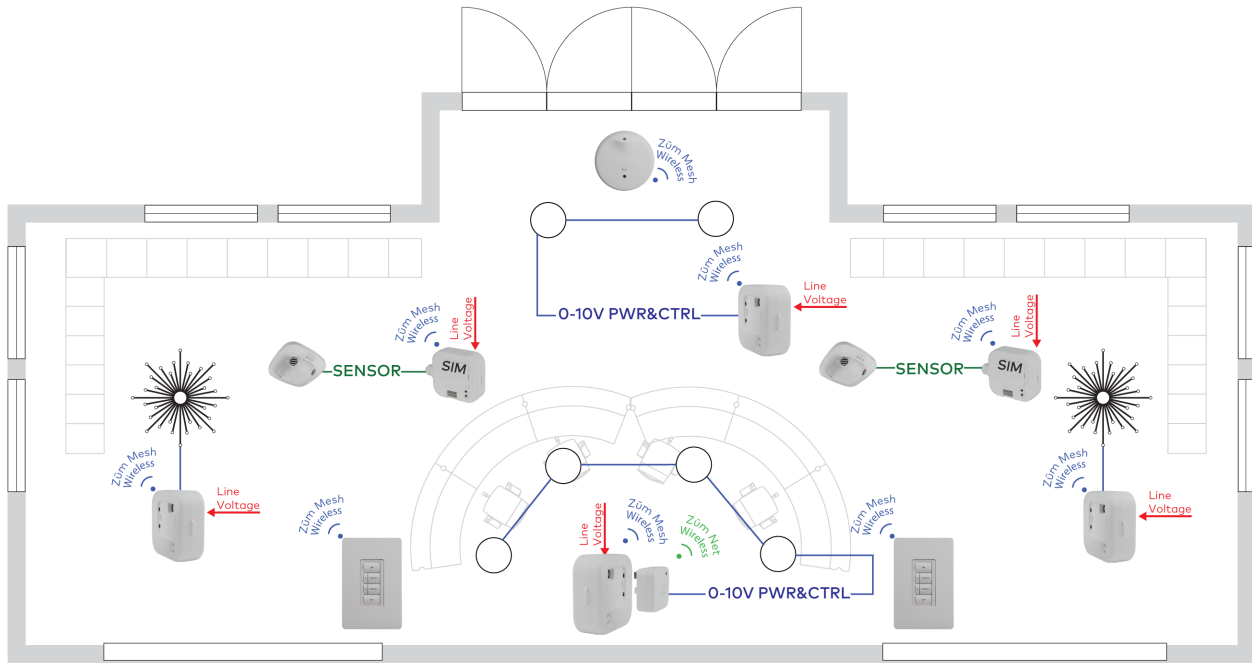

Code

Manual Control Device C405.2.5, C405.2.2.2 Physical control interface for occupant
Occupancy Sensor Full On C405.2.1, C405.2.1.1 Full ON during occupancy
Occupancy Sensor Partial Off C405.2.1 Partial Off during vacancy
Daylight Response C405.2, C405.2.61 Exception C405.2.3.1 Adjust lights based on available daylight

Zūm® Wireless: 0 - 10V Drivers



Bill of Materials

Item	Product	Qty
	ZUMMESH-JBOX-16A-LV Zūm Mesh, Dimmer, 0-10V, 16A	3
	ZUMMESH-JBOX-16A-LV + NETBRIDGE Zūm Mesh, Dimmer, 0-10V, 16A + Network Bridge	1
	ZUMMESH-JBOX-SIM Zūm Mesh JBox Sensor	2
	ZUMMESH-KP10CBATT Zūm Mesh, Battery-Powered Keypad	2
	ZUMMESH-OL-PHOTOCELL-BATT Zūm Mesh, Battery-Powered Daylight Sensor	1
	GLA-DT-QUATTRO-COM1-24 Presence Detector	2

Code

- Manual Control Device**
C405.2.5, C405.2.2.2
Physical control interface for occupant

- Programmable Timeclock**
C405.2.2.1, C405.2.6.2,
C405.2.6.3, C405.2.6.4
Programmable partial On

- Occupancy Sensor Full On**
C405.2.1, C405.2.1.1
Full ON during occupancy



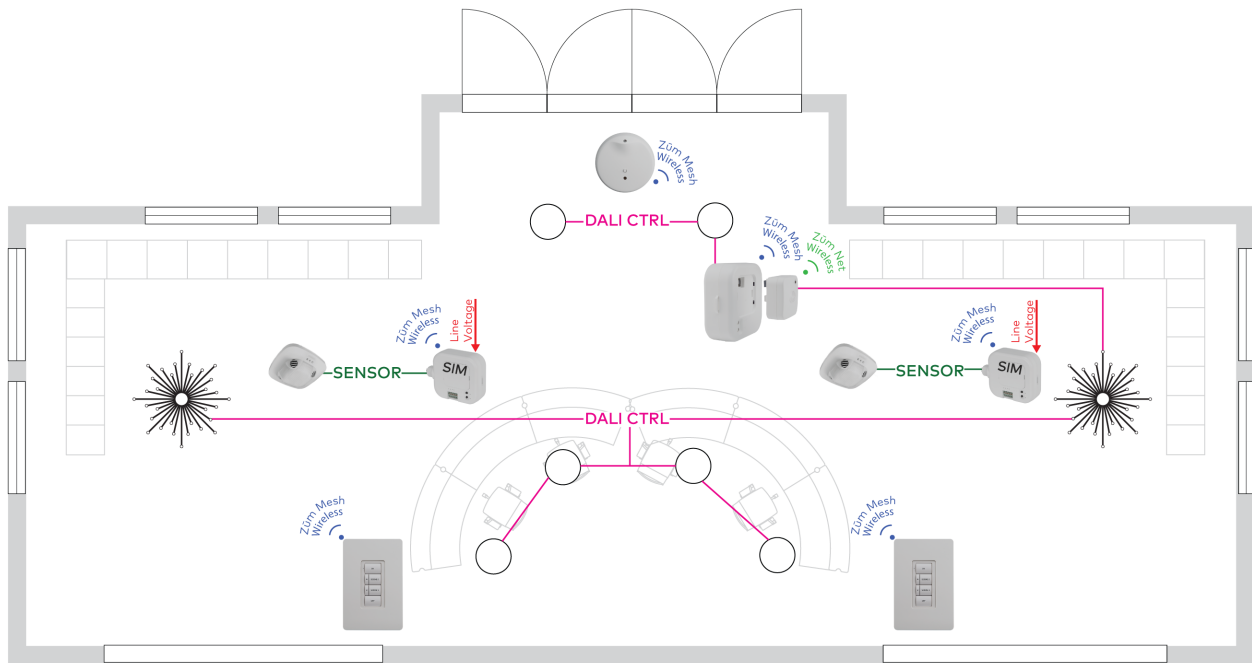

- Occupancy Sensor Full Off**
C405.2.1
Auto Off during vacancy

- Daylight Response**
C405.2, C405.2.61
Exception C405.2.3.1
Adjust lights based on available daylight

Züm® Wireless: DALI® Drivers



Bill of Materials

Item	Product	Qty
	ZUMMESH-JBOX-DALI + NETBRIDGE Züm Mesh, DALI, + Network Bridge	1
	ZUMMESH-JBOX-SIM Züm Mesh JBox Sensor	2
	ZUMMESH-KP10CBATT Züm Mesh, Battery-Powered Keypad	2
	ZUMMESH-OL-PHOTOCELL-BATT Züm Mesh, Battery-Powered Daylight Sensor	1
	GLA-DT-QUATTRO-COM1-24 Presence Detector	2

Code

- Manual Control Device**
C405.2.5, C405.2.2.2
Physical control interface for occupant

- Programmable Timeclock**
C405.2.2.1, C405.2.6.2, C405.2.6.3, C405.2.6.4
Programmable partial On

- Occupancy Sensor Full On**
C405.2.1, C405.2.1.1
Full ON during occupancy



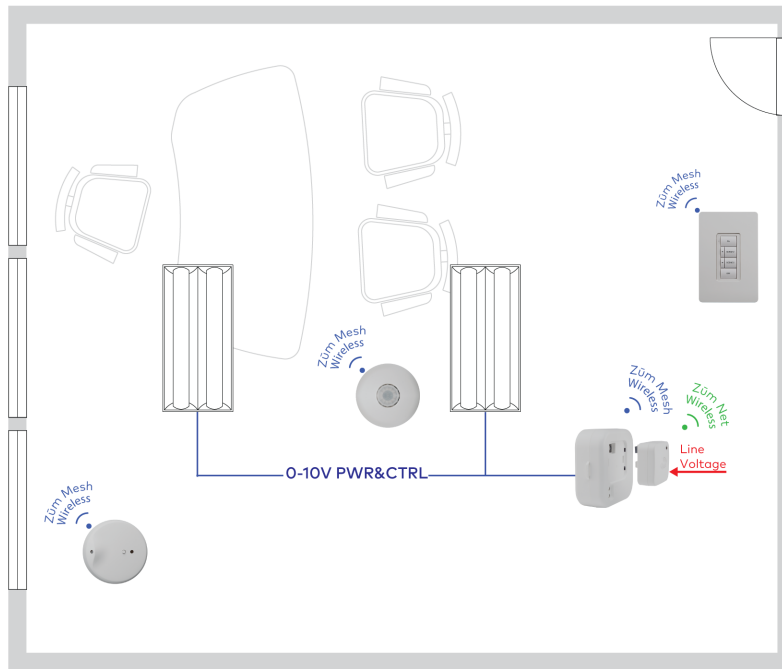

- Occupancy Sensor Full Off**
C405.2.1
Auto Off during vacancy

- Daylight Response**
C405.2, C405.2.61
Exception C405.2.3.1
Adjust lights based on available daylight

Zūm® Wireless: 0 - 10V Drivers



Bill of Materials

Item	Product	Qty
	ZUMMESH-JBOX-16A-LV + NETBRIDGE Zūm Mesh, Dimmer, 0-10V, 16A + Network Bridge	1
	ZUMMESH-KP10CBATT Zūm Mesh, Battery-Powered Keypad	1
	ZUMMESH-OL-PHOTOCELL-BATT Zūm Mesh, Battery-Powered Daylight Sensor	1
	ZUMMESH-PIR-VACANCY-BATT Zūm Mesh, Battery-Powered Vacancy Sensor	1

Code

Manual Control Device
C405.2.5, C405.2.2.2
Physical control interface for occupant

Vacancy Sensor Manual On
C405.2.1.1
Physical control interface for occupant, Auto Off during vacancy



Occupancy Sensor Full Off
C405.2.1
Auto Off during vacancy

Daylight Response
C405.2, C405.2.61
Exception C405.2.3.1
Adjust lights based on available daylight

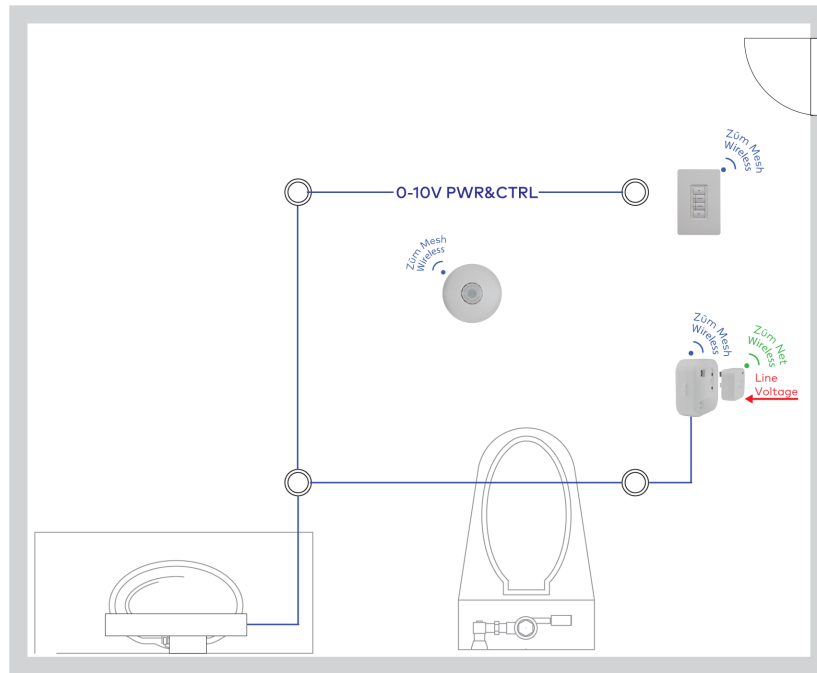
Zūm® Wireless: 0 - 10V Drivers



Bill of Materials

Item	Product	Qty
	ZUMMESH-JBOX-16A-LV + NETBRIDGE Zūm Mesh, Dimmer, 0-10V, 16A + Network Bridge	1
	ZUMMESH-KP10CBATT Zūm Mesh, Battery-Powered Keypad	1
	ZUMMESH-PIR-OCCUPANCY-BATT Zūm Mesh, Battery-Powered Sensor	1



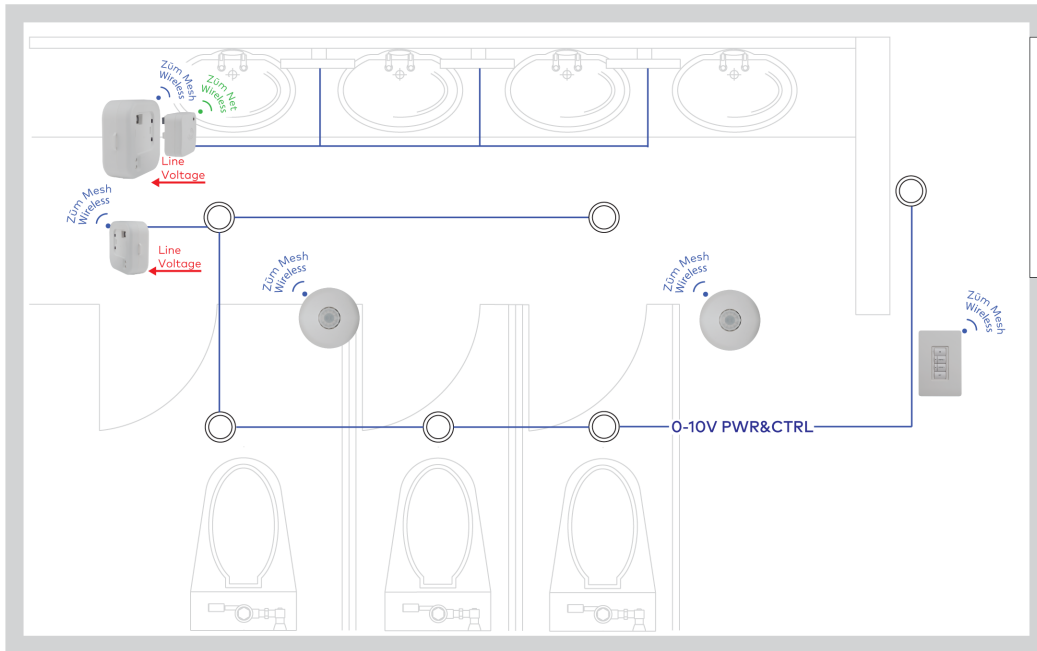

Code

- Manual Control Device**
C405.2.5, C405.2.2.2
Physical control interface for occupant
- Occupancy Sensor Full On**
C405.2.1, C405.2.1.1
Full ON during occupancy
- Occupancy Sensor Full Off**
C405.2.1
Auto Off during vacancy
- Daylight Response**
C405.2, C405.2.61
Exception C405.2.3.1
Adjust lights based on available daylight

Zūm® Wireless: 0 - 10V Drivers



Bill of Materials

Item	Product	Qty
	ZUMMESH-JBOX-16A-LV Zūm Mesh, Dimmer, 0-10V, 16A	1
	ZUMMESH-JBOX-16A-LV + NETBRIDGE Zūm Mesh, Dimmer, 0-10V, 16A + Network Bridge	1
	ZUMMESH-KP10CBATT Zūm Mesh, Battery-Powered Keypad	1
	ZUMMESH-PIR-OCCUPANCY-BATT Zūm Mesh, Battery-Powered Sensor	2

Code

- Manual Control Device**
C405.2.5, C405.2.2.2
Physical control interface for occupant

- Occupancy Sensor Full On**
C405.2.1, C405.2.1.1
Full ON during occupancy



- Occupancy Sensor Full Off**
C405.2.1
Auto Off during vacancy

- Daylight Response**
C405.2, C405.2.61
Exception C405.2.3.1
Adjust lights based on available daylight

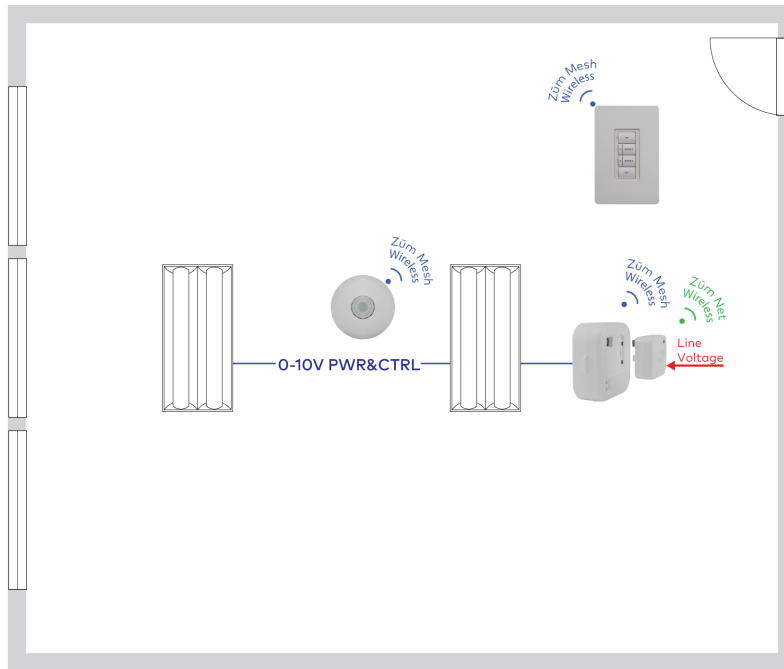
Zūm® Wireless: 0 - 10V Drivers



Bill of Materials

Item	Product	Qty
	ZUMMESH-JBOX-16A-LV + NETBRIDGE Zūm Mesh, Dimmer, 0-10V, 16A + Network Bridge	1
	ZUMMESH-KP10CBATT Zūm Mesh, Battery-Powered Keypad	1
	ZUMMESH-PIR-VACANCY-BATT Zūm Mesh, Battery-Powered Vacancy Sensor	1

Code

Manual Control Device

C405.2.5, C405.2.2.2
Physical control interface for occupant

Vacancy Sensor Manual On

C405.2.1.1
Physical control interface for occupant, Auto Off during vacancy

Occupancy Sensor Full Off

C405.2.1
Auto Off during vacancy

Daylight Response

C405.2, C405.2.61
Exception C405.2.3.1
Adjust lights based on available daylight

Contact Info

Name

Company

Address 1

Address 2

City, State, Zip

Phone

Email

Website

Project Notes

Square Footage

Cost/Sq. Ft.

--	--