

Crestron **DTT-15V2**
DualTouch™ Technology Touchpanel
Operations Guide



This document was prepared and written by the Technical Documentation department at:



Crestron Electronics, Inc.
15 Volvo Drive
Rockleigh, NJ 07647
1-888-CRESTRON

Contents

DualTouch™ Technology Touchpanel: DTT-15V2	1
Introduction	1
Features and Functions	1
Specifications	3
Physical Description	4
Industry Compliance.....	9
Setup.....	9
Hardware Hookup.....	9
Display Settings.....	11
The Kensington® Security Slot.....	15
Using the Pen.....	15
Cleaning.....	16
Alternative Mounting	16
Problem Solving	17
Troubleshooting.....	17
Further Inquiries	18
Future Updates.....	18
Return and Warranty Policies.....	19
Merchandise Returns / Repair Service.....	19
CRESTRON Limited Warranty.....	19

DualTouch™ Technology Touchpanel: DTT-15V2

Introduction

Features and Functions

The DTT-15V2 is a 15-inch touchpanel designed for use with the UPX-2 Universal Presentation System. The Crestron® exclusive DualTouch™ Technology (patent pending) allows the DTT-15V2 to function both as a touchpanel and a pen-based annotation device to produce an amazingly flexible presentation solution.

The Crestron DualTouch Technology touchpanel employs a combination of analog resistive touch sensing for fingertip-operated touchpanel control and the exclusive Wacom® pen-based technology for precise drawing and annotation. Switching between modes is automatic and instantaneous, disabling the analog membrane whenever the pen is sensed, allowing users to rest the palm of their hand naturally on the screen while drawing. The DTT-15V2 includes a tabletop stand with versatile tilt adjustment.

Functional Summary

- Provides the primary user interface for the Crestron UPX-2 Universal Presentation Processor
- Displays high-resolution RGB video from the UPX-2
- Features a bright 15-inch color display with 1024 x 768 native resolution
- Employs DualTouch Technology to support touchpanel control and pen-based annotation as part of a complete UPX-2 system
- Provides VESA mount location
- Provides a Kensington® security slot (refer to page 15)
- Includes a pen tether
- Includes a tabletop stand with versatile tilt adjustment

NOTE: The DTT-15V2 can only be used with the UPX-2.

DTT-15V2 DualTouch Technology Touchpanel and UPX-2 Universal Presentation Processor Typical Application

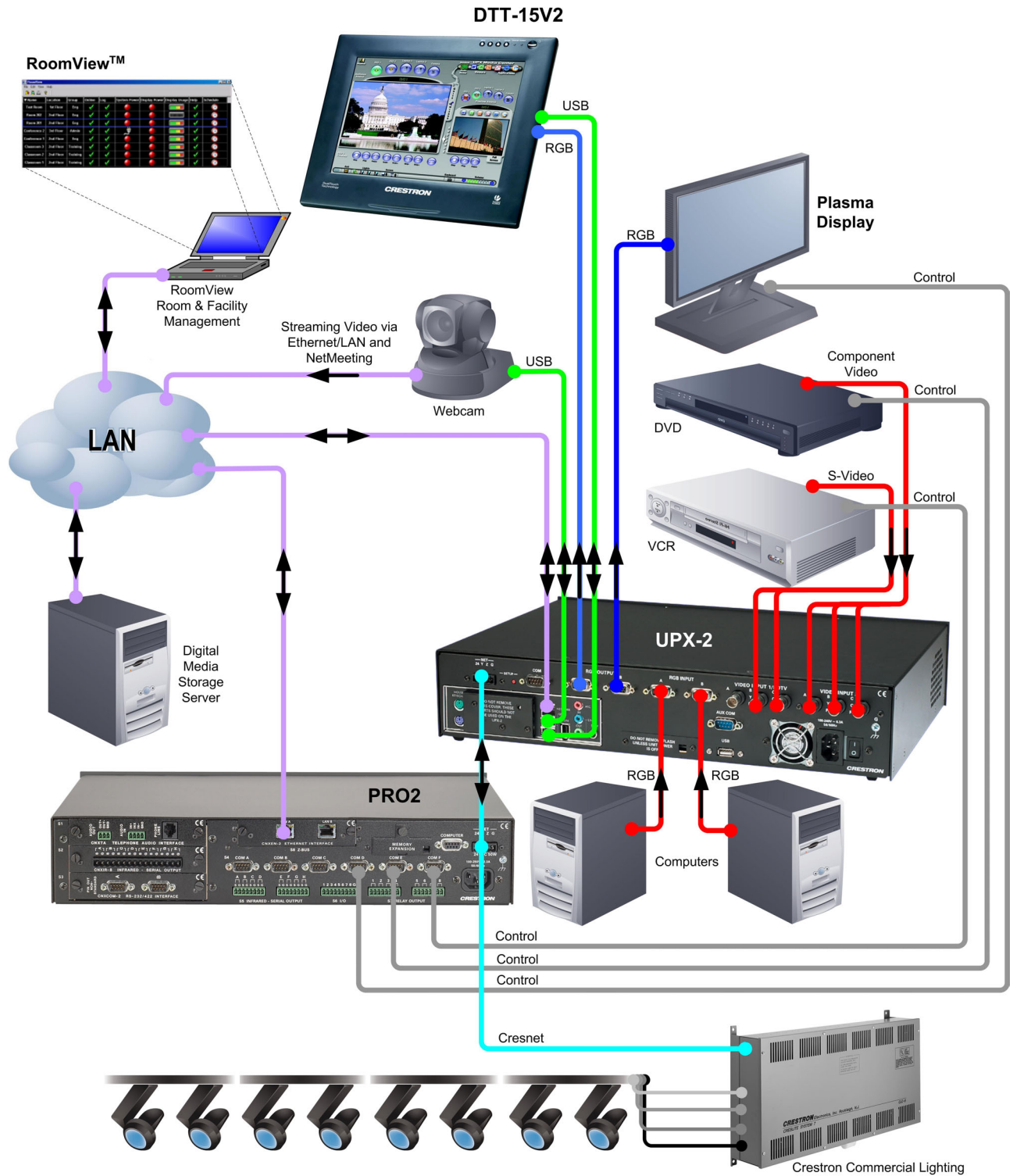

Specifications

The following table provides a summary of specifications for the DTT-15V2.

DTT-15V2 Specifications

SPECIFICATION	DETAILS
Power Requirements	24 Watts (2.0 Amps @ 12 Volts DC Power Supply Included)
Connectors	
Power	One connector for the power supply (included)
RGB Video In	One RGB D15HD Female Connector
RGB Video Out	One RGB D15HD Female Connector
USB	One USB Port (Type "B" Female Connector)
Controls and Indicators	Display Controls – Four Pushbuttons for Setup Controls Power – One Pushbutton to turn On/Off PWR LED – Indicates power status and presence of video signal Status LED - Indicates sensing of Annotation Pen
Annotation Pen	
Pen Pressure	512 levels
Pen Switches	One side switch (rocker type)
Accuracy	± 1 pixel
Maximum Reading Height	0.2 in (5 mm)
Report Rate	93 points/second
Reading Technology	Electro-Magnetic Resonance
Display	
Display Type	Amorphous-Silicon Thin-Film Transistor (a-Si TFT) Active Matrix Color LCD
Screen Size	15 inch (38.1 cm) diagonal
Active Area	11.98 inch x 8.99 inch (30.41 cm x 22.80 cm)
Resolution	1024 x 768 pixels (XGA), 800 x 600 pixels (SGA), 640 x 480 pixels (VGA)
Color Depth	16,777,216 (24 bit), 256 levels
Contrast Ratio	250:1
Brightness	200 cd/m ²
Viewing Angle	± 80 degrees horizontal, ± 80 degrees vertical
Touchscreen	Resistive Membrane
Screen Tilt	Adjustable from 15 to 72 degrees
Operating Environment	Temperature: 41° to 95°F (5° to 35°C) Humidity: 20% to 80% RH (non-condensing)
Dimensions and Weight	Height: 12.90 in (32.77 cm) at maximum stand elevation 4.82 in (12.24 cm) at minimum stand elevation Width: 15.76 in (40.03 cm) Depth: 7.88 in (20.02 cm) at maximum stand elevation 12.59 in (31.98 cm) at minimum stand elevation Weight: 10.8 lbs (4.9 kg)

Physical Description

The electronic hardware is housed in a black molded plastic enclosure, shown in the following illustration. This touchpanel is designed for placement on a counter. It possesses an adjustable stand, which can tilt from 15 to 72 degrees. All video and power connections are made at the rear of the unit.



Each DTT-15V2 LCD panel is produced under very stringent quality control standards. Because production techniques cannot guarantee an absolutely perfect TFT display, some panels may exhibit a small number of pixels that display an incorrect color. This does not qualify the device as defective.

The quality control standards are based on internationally accepted standards for LCD monitors. Of the 786,432 pixels on each DTT-15V2, 99.999% are required to function perfectly, and no pixels are allowed to be always white or always black. A small number of pixels (10 or less) may acceptably display an incorrect color for some portion of the color spectrum.

DTT-15V2 Physical View – Front

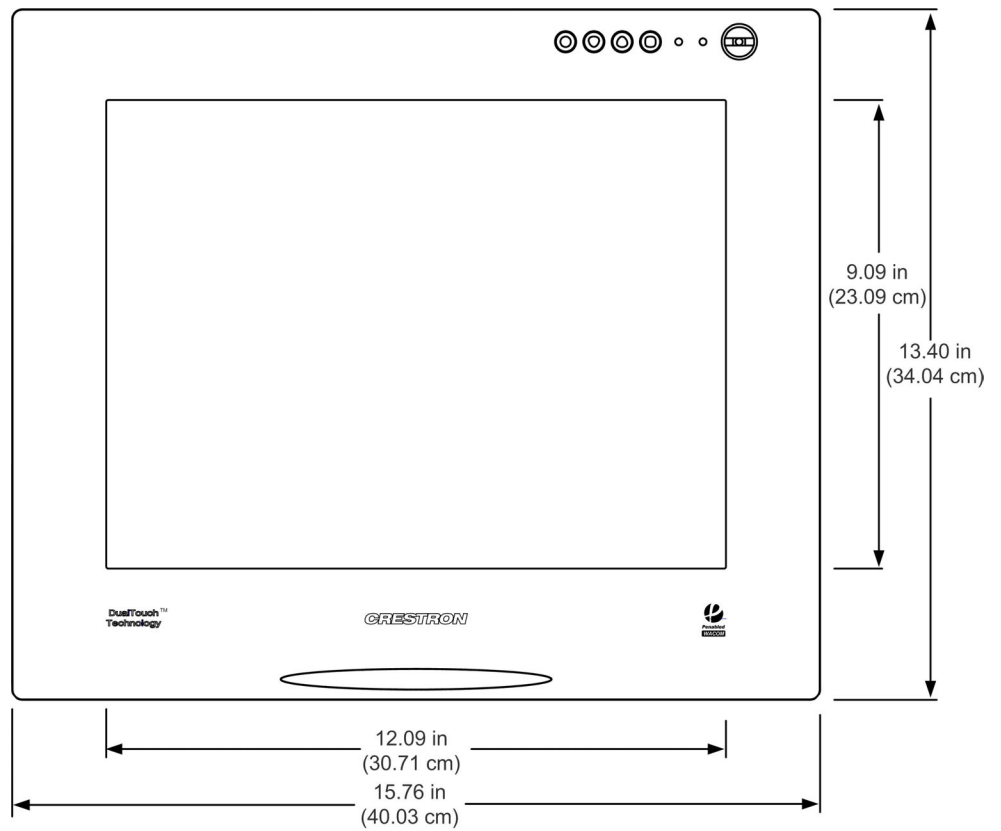

DTT-15V2 Physical View – Side (Maximum and Minimum Height)

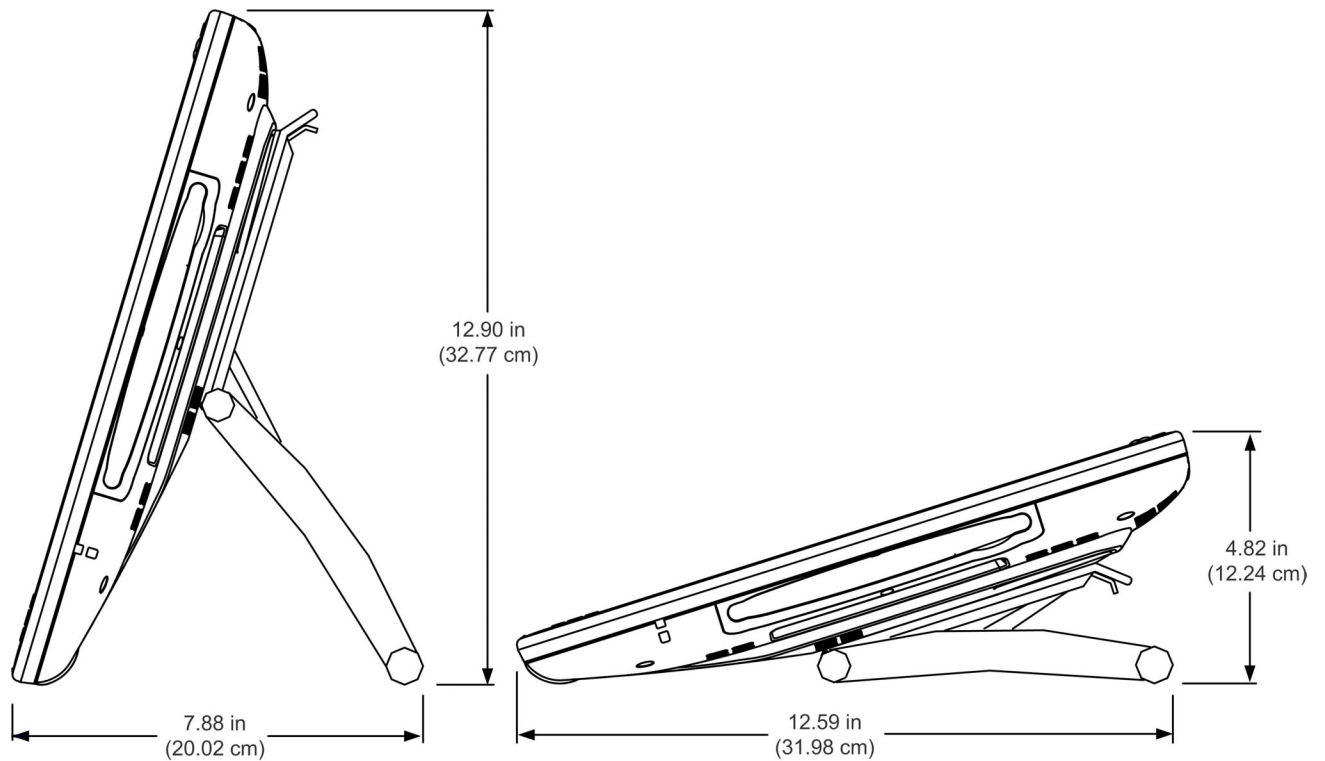

DTT-15V2 Physical View – Rear (Stand Not Shown)

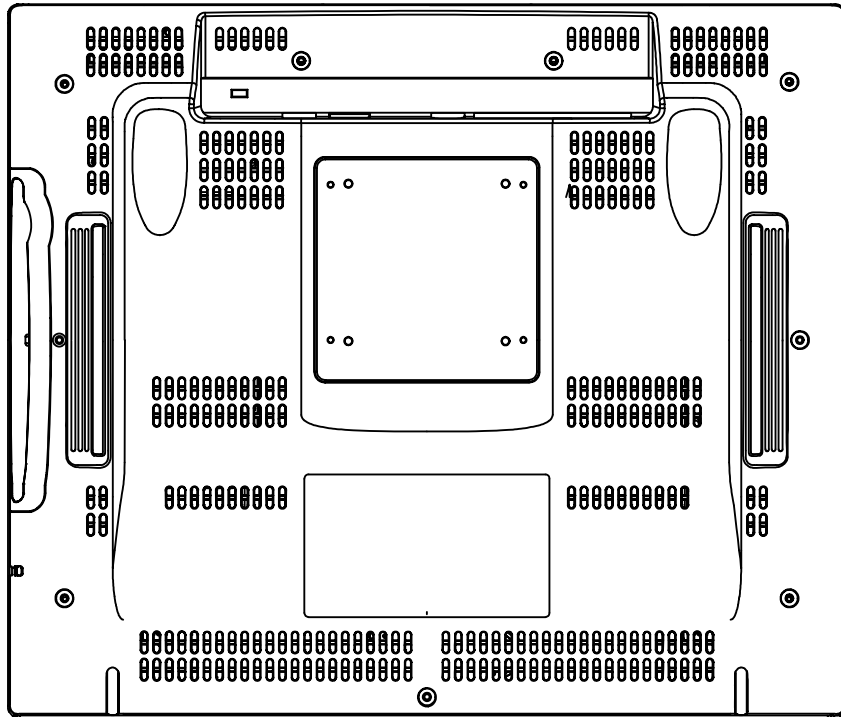

The DTT-15V2 is shipped with the following accessories.

One Pen
(with five tip replacements)

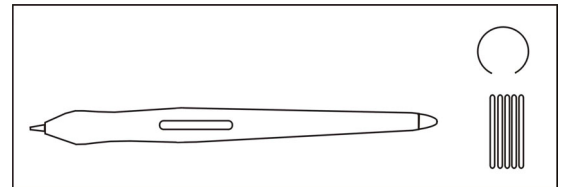

One USB Cable
Approximately 6-feet long.

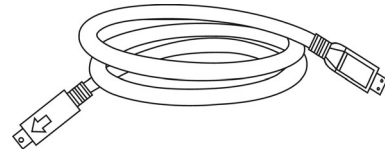

One VGA to VGA Cable
Approximately 6-feet long.

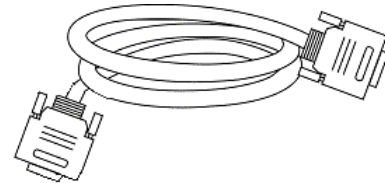

One Power Supply and
Power Cable

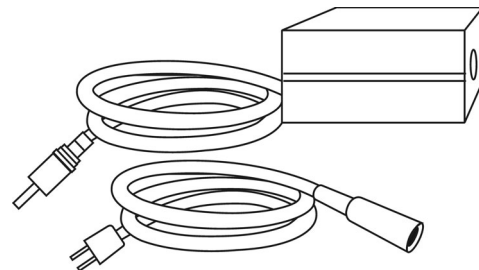

One Pen Tether

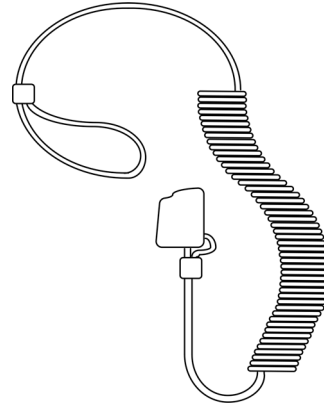

Ports

The ports are located on the rear of the DTT-15V2.

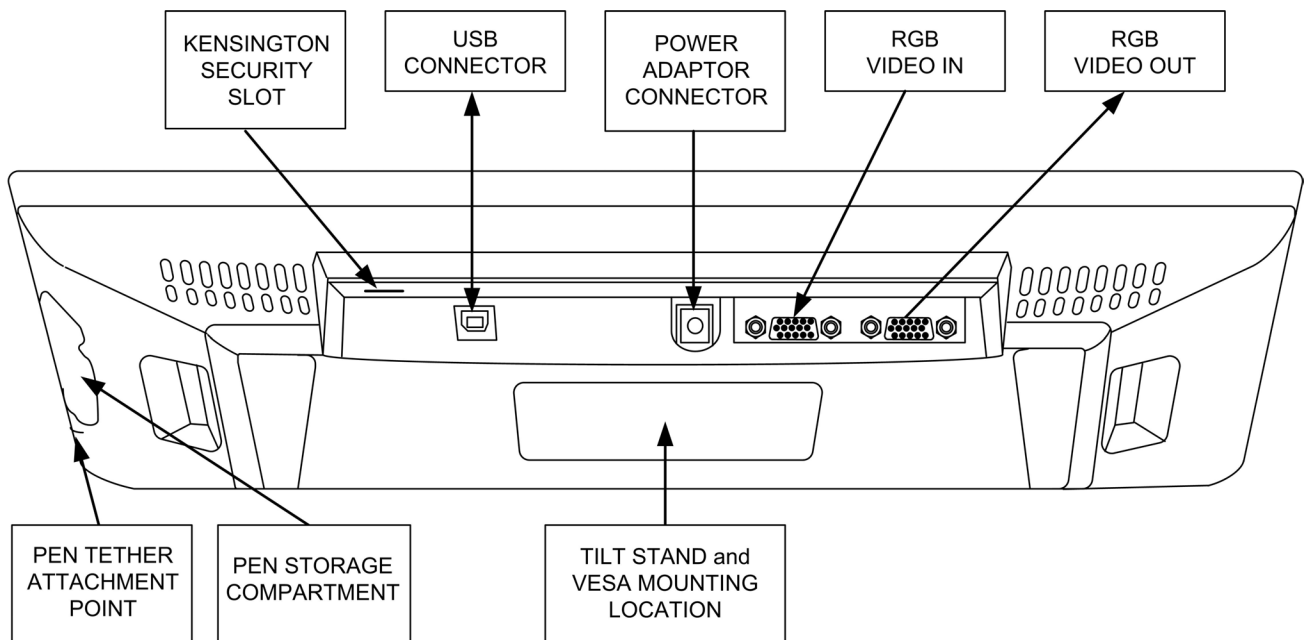

USB 2.0

One Universal Serial Bus (USB) type “B” female connector is provided for data transfer, and may be connected to any of the four USB ports on the UPX-2.

USB Type B Connector Pinout

PIN	DESCRIPTION
1	+5 VDC
2	Data -
3	Data +
4	Ground

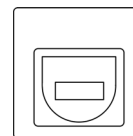

Power Adaptor Connector

One DC IN connector provides connection for the power supply, 24 Watts (2.0 Amps @ 12 Volts DC, power supply included).



RGB IN

One DB15HD RGB (VGA) female connector is provided for video input.

RGB IN Connector Pinout

PIN	DESCRIPTION
1	Red video input
2	Green video input
3	Blue video input
4	GND
5	GND
6	GND
7	GND
8	GND
9	Not Connected
10	GND
11	Not Connected
12	DDC Clock
13	Horizontal Sync
14	Vertical Sync
15	DDC Data

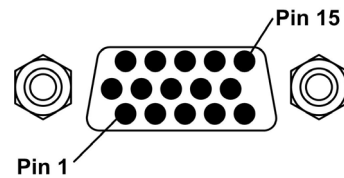

RGB OUT

One DB15HD RGB (VGA) female connector is provided for video output to a projector device (not used in this application).

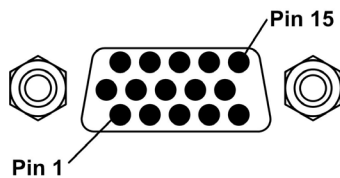

Controls and Indicators

A power on/off switch and a power LED are located in the upper right corner of the DTT-15V2. The DTT-15V2 conforms to VESA and ENERGY STAR® power savings guidelines. When using this device with a VESA Display Power Management Signaling (DPMS) compliant computer or graphics card, the DTT-15V2 automatically complies with the following power saving parameters.

- The power indicator is orange when power is applied and no video source is present.
- The power indicator is blue when power is applied and a video signal is applied.
- The status indicator is blue when the DTT-15V2 senses the annotation pen touchdown.

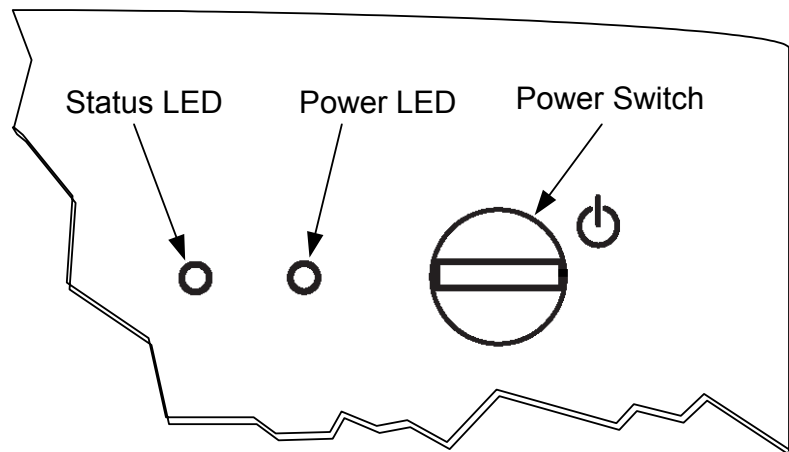

Industry Compliance

As of the date of manufacture, the DTT-15V2 has been tested and found to comply with specifications for CE marking and standards per EMC and Radiocommunications Compliance Labelling.



NOTE: This device complies with part 15 of the FCC rules. Operation is subject to the following two conditions: (1) this device may not cause harmful interference, and (2) this device must accept any interference received, including interference that may cause undesired operation.

Setup

Hardware Hookup

Refer to the following diagram and complete the connections as specified. Ensure that the UPX-2 and the DTT-15V2 are both powered down before beginning.

CAUTION: To avoid damage to the DTT-15V2 or to your video card, never connect or disconnect the video or power cable while the DTT-15V2 or the UPX-2 are powered up.

NOTE: The maximum continuous current from equipment under any external load conditions shall not exceed a current limit that is suitable for the minimum wire gauge used in interconnecting cables. The ratings on the connecting unit's supply input should be considered to prevent overloading the wiring.

NOTE: The USB cable may be extended using up to four 16-foot active extensions. Each extension cable must contain a hub (repeater) to regenerate the USB signal (maximum of 64 feet). For longer extensions, Crestron has tested and approved IOGEAR USB Extender model GUCE50, which allows up to 150 feet over CAT5.

NOTE: Using high quality cable, the VGA cable may be extended up to a maximum of about 10 meters (32.8 ft.) for analog VGA at 1024 x 768. If you need a longer run, add VGA extenders or VGA distribution amplifiers.

1. Connect the RGB/VGA cable, linking the UPX-2 RGB OUTPUT A connector to the DTT-15V2 RGB VIDEO IN connector.
2. Connect the USB cable, linking the UPX-2 USB port to the DTT-15V2 USB port.
3. Connect the power supply line cord to an AC outlet and the power supply adaptor.
4. Plug the power adaptor cord into the DTT-15V2 DC IN port.
5. Power up the DTT-15V2. The power indicator should light up orange.
6. Power up the UPX-2. When a video signal is applied to the DTT-15V2, the power indicator will turn blue.

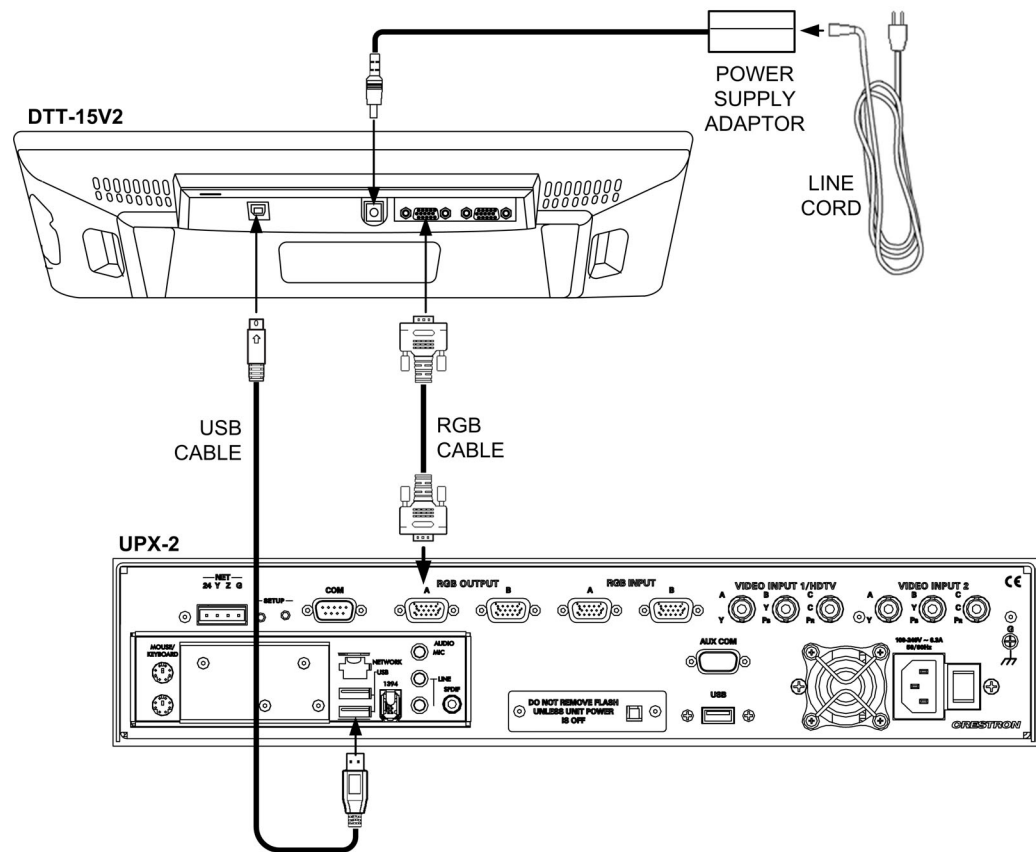
Connecting the DTT-15V2 to the UPX-2

Display Settings

Four controls are located on the upper right front side of the DTT-15V2 for display setup.

Display Controls

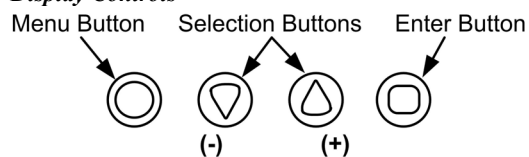

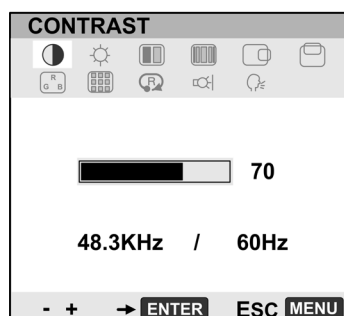

The **Menu** button provides access to the following 11 adjustment menus. Use the Selection (-)/(+) buttons to select a menu or advance forward or backward through the 11 menus. Press the **Enter** button to open and save the selected menu.

1. Contrast – Use the selection (-)/(+) buttons to decrease or increase contrast, press the **Enter** button to save. Default is 70.

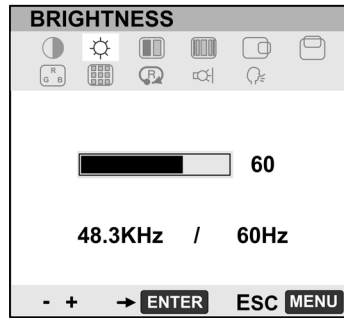

- Brightness – Use the (-)/(+) buttons to decrease or increase brightness, press the **Enter** button to save. Default is 60.



- Phase – Use the (-)/(+) buttons to manually reduce horizontal distortion lines. The **Reset** option  is used for automatic adjustment. Press **Enter** to save. Default is 132.

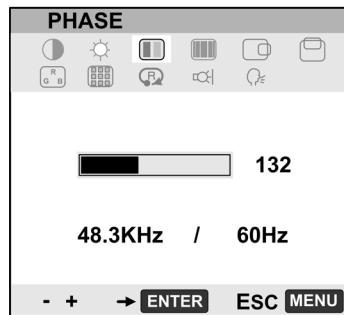

- Pitch – Use the (-)/(+) buttons to manually reduce vertical distortion lines. The **Reset** option  is used for automatic adjustment. Press **Enter** to save. Default is 1328.

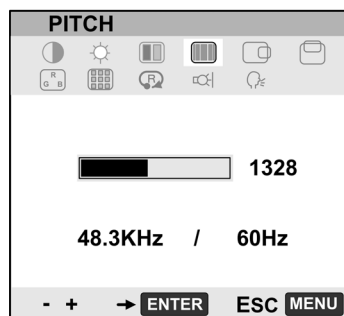

5. Horizontal Center – Use the (-)/(+) buttons to manually move the image left or right. The **Reset** option  is used for automatic adjustment. Press **Enter** to save. Default is 50.

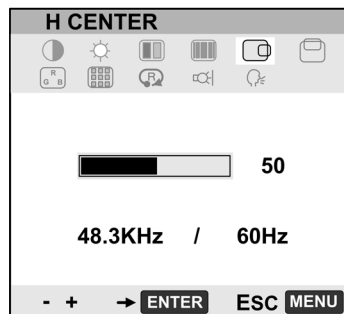

6. Vertical Center – Use the (-)/(+) buttons to manually move the image down or up. The **Reset** option  is used for automatic adjustment. Press **Enter** to save. Default is 50.

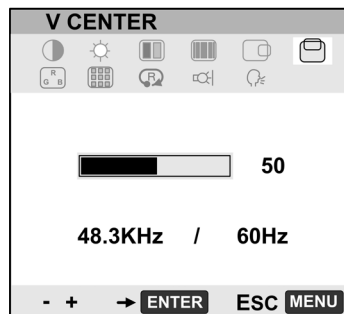

7. Menu Position – Use the (-)/(+) buttons to move the menu to one of the available nine positions. Press **Enter** to save. Default is center position.

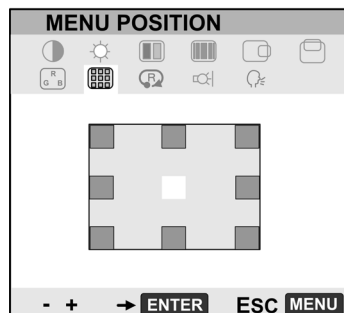

8. Reset – Use **AUTO ADJUST** to reset only the image parameters (menus 1 through 6). Use **RECALL** to reset all screen options to the factory default. Select the exit icon to leave this menu without making any changes.

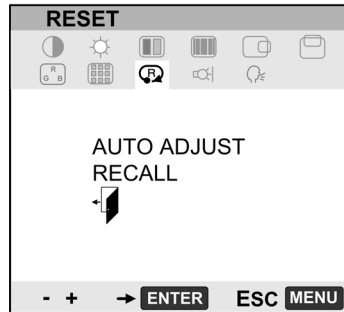

9. Backlight – Use the (-)/(+) buttons to decrease or increase the backlight brightness. Press **Enter** to save. Default is 80.

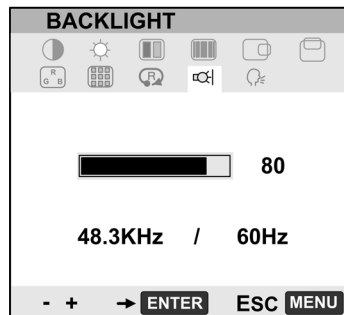

10. Color – Provides a color temperature selection of 9300K, 6500K, 5000K, DIRECT (no adjustment to the incoming signal) and a USER option to use the independent RGB adjustment.

Click the  icon to allow an independent adjustment of red, green and blue. Press **Enter** to save. Defaults are shown as follows.

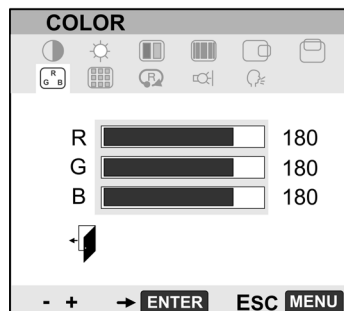
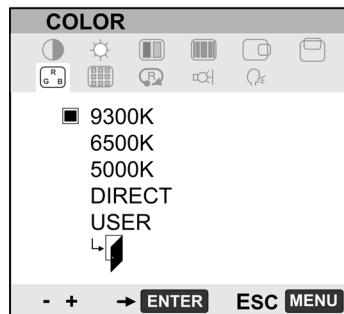

NOTE: Manual changes invalidate the standard profile settings.

11. Language – Use the (-)/(+) buttons to select a language for the display adjustment menus. Press **Enter** to save. Default is English.



The Kensington® Security Slot

The Kensington Security Slot is an industry standard that gives customers the best option for the physical security of computer and electronic equipment. The security slot is marked with a lock and K icon. To prevent unauthorized removal, you can attach one end of a Kensington security cable to this slot and the other end to an immovable object. Refer to the Kensington website for additional details (<http://www.kensington.com>).

Using the Pen

While working with the DTT-15V2, you can rest your hand on the surface of the display screen, just as if you were drawing on a sheet of paper. The pen is activated as soon as it enters proximity, about 0.2 inches (5 mm) above the surface. This allows you to position the screen cursor before touching the pen tip to the surface.

When the pen tip contacts the surface of the DTT-15V2, the tip switch is activated. The tip switch simulates clicking and holding a mouse button. Raising the tip above the surface of the DTT-15V2 is the same as releasing a mouse button.

The pen comes with five extra tips. The pen tip will wear with normal use. Worn tips feel more drag when you draw, or it seems as if you are scratching the overlay with your pen. It can be easily replaced with one of the extra pen tips. Replacement pens and a 5-pack of replacement pen nibs are available from the Wacom website (<http://wacomdirect.wacom.com>).

Grasp the worn tip with a pair of needle-nose pliers, tweezers, or similar instrument and pull out the tip.

Firmly slide the new tip (square end first) into the barrel of the pen and press in until it stops.

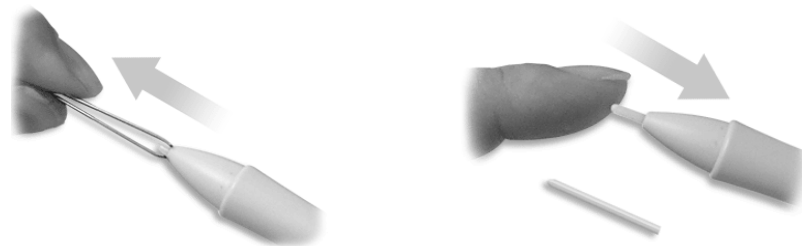

NOTE: A badly worn pen tip may damage the surface.

Cleaning

Keep the pen and screen surface clean. Dust and dirt particles can stick to the pen and cause wear to the screen surface. Regular cleaning will help to prolong the life of your equipment.

- To clean the outer casing, stand, and pen, use a soft cloth and a mild detergent (such as dishwashing liquid) diluted in water. Do not use paint thinner, benzene, alcohol or other solvents.
- To clean the surface of the display screen, use an anti-static cloth or very slightly dampened cloth. Apply only very light pressure and do not make the screen surface wet. Never use detergents or solvents to clean the screen.

Alternative Mounting

The DTT-15V2 may be removed from the adjustable stand and remounted to a VESA® conforming mount arm or stand. The Video Electronics Standards Association (VESA) is an international non-profit corporation that supports and sets industry-wide interface standards for the PC, workstation, and computing environments. VESA's Flat Display Mounting Interface (FDMI) Standard defines a set of mounting interface standards for the complete range of flat displays with viewing areas ranging in size from 102 mm (4") to 2286 mm (90") diagonal. FDMI supports a broad range of mounting options including desktop, wall, overhead, mobile and specialty mounting applications. Corresponding standards describe the interface mounting pads, wall mount brackets and other mounting apparatus to be provided by mounting equipment manufacturers. The complete standard is available on the VESA website. The DTT-15V2 is VESA MIS-D, 100/75, C compliant, and is equipped with a 75 x 75 mm mounting hole pattern.

Follow these instructions for removing the adjustable stand and attaching the DTT-15V2 to an alternative VESA conforming mount.

1. Turn off the system and disconnect all cables.
2. Protect the screen surface by placing the DTT-15V2 facedown on a soft cloth.
3. Remove the four screws that secure the stand.
4. Use four M4 regular screws, no longer than 15 mm, 7 mm wide with a 0.7 mm pitch to attach the new mounting.

NOTE: Screws longer than 15 mm could damage the DTT-15V2.

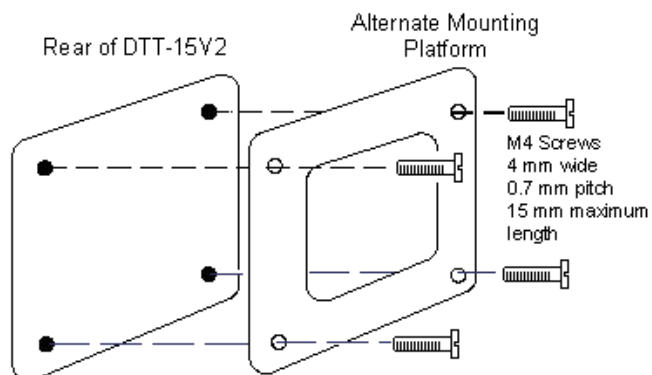

CAUTION: When attaching the DTT-15V2 to an alternate mounting platform, be sure to follow all instructions supplied by the manufacturer.

Problem Solving

Troubleshooting

The following table provides corrective action for possible trouble situations. If further assistance is required, please contact a Crestron customer service representative.

DTT-15V2 Troubleshooting

TROUBLE	POSSIBLE CAUSE(S)	CORRECTIVE ACTION
DTT-15V2 does not function.	The DTT-15V2 is not receiving power. The Power LED is off.	Verify cable connections and power to unit.
	The DTT-15V2 is receiving power. The Power LED is on.	Check contrast, brightness and back-light controls. Refer to page 12 and 14.
Multiple images displayed.	The video cable is over-extended.	Use the video cable without extensions or use a higher quality cable.
White color appears off-white.	The colors are not set up correctly.	Return to factory settings or adjust the colors as necessary.
VGA display ripples or shows a moiré pattern.	The pitch and/or phase is misadjusted.	Adjust pitch and/or phase. Refer to page 12.
The message: "NO SIGNAL GO TO POWER SAVE" is displayed.	The system may be in power management mode.	Touch the pen tip to the screen, move the mouse connected to the UPX-2, or press any key on the keyboard connected to the UPX-2.
	The video cable connection may be loose or broken.	Check the video cable connection.
The message: "CABLE DISCONNECT GO TO POWER SAVE" is displayed.	The video cable connection may be loose or broken.	Check the video cable connection.
The message: "OUT OF RANGE" is displayed.	Input signal frequency is incorrect or not compatible.	Vertical frequency refresh rate is a value between 45 and 75 Hz (for XGA, vertical refresh rate is 45 to 70 Hz).
	The resolution is set too high.	Set the resolution to a maximum of 1024 x 768.
The message: "Please set the refresh rate at 70Hz or less" is displayed.	The refresh rate is set too high for XGA.	Set the refresh rate for XGA to a value between 45 and 70 Hz.

Further Inquiries

If you cannot locate specific information or have questions after reviewing this guide, please take advantage of Crestron's award winning customer service team by calling the Crestron corporate headquarters at 1-888-CRESTRON [1-888-273-7876]. For assistance in your local time zone, refer to the Crestron website (www.crestron.com) for a listing of Crestron worldwide offices.

You can also log onto the online help section of the Crestron website to ask questions about Crestron products. First-time users will need to establish a user account to fully benefit from all available features.

Future Updates

As Crestron improves functions, adds new features, and extends the capabilities of the DTT-15V2, additional information may be made available as manual updates. These updates are solely electronic and serve as intermediary supplements prior to the release of a complete technical documentation revision.

Check the Crestron website periodically for manual update availability and its relevance. Updates are identified as an “Addendum” in the Download column.

Return and Warranty Policies

Merchandise Returns / Repair Service

1. No merchandise may be returned for credit, exchange, or service without prior authorization from CRESTRON. To obtain warranty service for CRESTRON products, contact the factory and request an RMA (Return Merchandise Authorization) number. Enclose a note specifying the nature of the problem, name and phone number of contact person, RMA number, and return address.
2. Products may be returned for credit, exchange, or service with a CRESTRON Return Merchandise Authorization (RMA) number. Authorized returns must be shipped freight prepaid to CRESTRON, 6 Volvo Drive, Rockleigh, N.J. 07647, or its authorized subsidiaries, with RMA number clearly marked on the outside of all cartons. Shipments arriving freight collect or without an RMA number shall be subject to refusal. CRESTRON reserves the right in its sole and absolute discretion to charge a 15% restocking fee, plus shipping costs, on any products returned with an RMA.
3. Return freight charges following repair of items under warranty shall be paid by CRESTRON, shipping by standard ground carrier. In the event repairs are found to be non-warranty, return freight costs shall be paid by the purchaser.

CRESTRON Limited Warranty

CRESTRON ELECTRONICS, Inc. warrants its products to be free from manufacturing defects in materials and workmanship under normal use for a period of three (3) years from the date of purchase from CRESTRON, with the following exceptions: disk drives and any other moving or rotating mechanical parts, pan/tilt heads and power supplies are covered for a period of one (1) year; touchscreen display and overlay components are covered for 90 days; batteries and incandescent lamps are not covered.

This warranty extends to products purchased directly from CRESTRON or an authorized CRESTRON dealer. Purchasers should inquire of the dealer regarding the nature and extent of the dealer's warranty, if any.

CRESTRON shall not be liable to honor the terms of this warranty if the product has been used in any application other than that for which it was intended, or if it has been subjected to misuse, accidental damage, modification, or improper installation procedures. Furthermore, this warranty does not cover any product that has had the serial number altered, defaced, or removed.

This warranty shall be the sole and exclusive remedy to the original purchaser. In no event shall CRESTRON be liable for incidental or consequential damages of any kind (property or economic damages inclusive) arising from the sale or use of this equipment. CRESTRON is not liable for any claim made by a third party or made by the purchaser for a third party.

CRESTRON shall, at its option, repair or replace any product found defective, without charge for parts or labor. Repaired or replaced equipment and parts supplied under this warranty shall be covered only by the unexpired portion of the warranty.

Except as expressly set forth in this warranty, CRESTRON makes no other warranties, expressed or implied, nor authorizes any other party to offer any warranty, including any implied warranties of merchantability or fitness for a particular purpose. Any implied warranties that may be imposed by law are limited to the terms of this limited warranty. This warranty statement supercedes all previous warranties.

Trademark Information

All brand names, product names, and trademarks are the sole property of their respective owners. Windows is a registered trademark of Microsoft Corporation. Windows95/98/Me/XP and WindowsNT/2000 are trademarks of Microsoft Corporation.



Crestron Electronics, Inc.
15 Volvo Drive Rockleigh, NJ 07647
Tel: 888.CRESTRON
Fax: 201.767.7576
www.crestron.com

Operations Guide – DOC. 6342
02.05

Specifications subject to
change without notice.