



View this document in HTML
crestron.com/docs/7693

Scan the QR code for product documentation.



Security Reference Guide

AirMedia[®] Presentation Gateway

Original Instructions

The U.S. English version of this document is the original instructions.

All other languages are a translation of the original instructions.

Crestron product development software is licensed to Crestron dealers and Crestron Service Providers (CSPs) under a limited nonexclusive, nontransferable Software Development Tools License Agreement. Crestron product operating system software is licensed to Crestron dealers, CSPs, and end-users under a separate End-User License Agreement. Both of these Agreements can be found on the Crestron website at www.crestron.com/legal/software_license_agreement.

The product warranty can be found at www.crestron.com/warranty.

The specific patents that cover Crestron products are listed at www.crestron.com/legal/patents.

Certain Crestron products contain open source software. For specific information, visit www.crestron.com/opensource.

Crestron, the Crestron logo, 3-Series, 4-Series, .AV Framework, AirMedia, Crestron Connected, Crestron Fusion, Crestron Studio, DigitalMedia, DM, PinPoint, XiO Cloud, Zūm are either trademarks or registered trademarks of Crestron Electronics, Inc. in the United States and/or other countries. AirPlay, Apple, App Store, Bonjour, iCloud, iPad, iPhone, Mac, and macOS are either trademarks or registered trademarks of Apple, Inc. in the United States and/or other countries. IOS is either a trademark or registered trademark of Cisco Systems, Inc. in the United States and/or other countries. Dropbox is either a trademark or registered trademark of Dropbox Inc. in the United States and/or other countries. Android, Chromebook, Chrome OS, Google Chrome, Google Drive, Google Play, and YouTube are either trademarks or registered trademarks of Google, Inc. in the United States and/or other countries. HDMI and the HDMI logo are either trademarks or registered trademarks of HDMI Licensing, LLC in the United States and/or other countries. Kaptive is either a trademark or registered trademark of Light Blue Optics Ltd in the United States and/or other countries. Intel, Intel Core, and Intel Iris are either trademarks or registered trademarks of Intel Corporation in the United States and/or other countries. Active Directory, Excel, Microsoft, OneDrive, PowerPoint, Teams and Windows are either trademarks or registered trademarks of Microsoft Corporation in the United States and/or other countries. Miracast, Wi-Fi, and Wi-Fi Direct are either trademarks or registered trademarks of Wi-Fi Alliance in the United States and/or other countries. Zoom Rooms is either a trademark or registered trademark of Zoom Video Communications, Inc. in the United States and/or other countries. Other trademarks, registered trademarks, and trade names may be used in this document to refer to either the entities claiming the marks and names or their products. Crestron disclaims any proprietary interest in the marks and names of others. Crestron is not responsible for errors in typography or photography.

HDMI

©2025 Crestron Electronics, Inc.

Contents

- Overview** 1
- Select the Right System** 2
 - AirMedia Series 3 Devices 2
 - AirMedia 2.0 Devices 5
 - AirMedia Devices 10
- AirMedia Network Infrastructure and Security** 11
 - AirMedia Bandwidth Requirements 12
 - Network Infrastructure and Design Considerations 12
 - Disable Discovery via Multicast DNS Services 14
 - Deployment Options for Guest Network Access 15
 - VLAN 15
 - Physical Air Gap 16
 - Guest Wireless Access Point Mode 16
 - Dual LAN Interface (AirMedia Series 3 Only) 19
 - Data Transport & Encrypted Communications 20
- AirMedia Device Considerations** 21
 - Device Naming 21
 - Device Configuration 21
 - Firewall Settings & Port Table 25
- Device Upgrades** 37
 - Single Device (Web Interface) 37
 - Multiple Devices 37
- Control** 38
 - .AV Framework and XiO Cloud Service 38
 - Crestron Connected 38
 - Control System 38
- Deploy AirMedia Sender Applications to PCs** 40
 - Windows 40
 - macOS 42
 - Deployment and Configuration Options 43
 - Windows File Deployment 43
 - MacOS File Deployment 44
 - Configuration File (config.ini) 44
 - Room List (XML File) for Windows and macOS 44
 - Application Configuration (XML File) for Windows 45
 - File Association for Windows and macOS 47
 - Discovery 47

Manual Entry	48
Custom URI Protocol	50
AirMedia Sender Applications for User Download	51
Use AirMedia	52
Welcome Screen	52
Connection Experience	54
Login Code	55
PC Sender Applications	56
User Experience with Windows	56
User Experience with macOS	64
User Experience with Chrome OS	70
Miracast	73
Required Wireless Adapter (AirMedia 2.0)	73
Miracast Behavior – How it Works	73
Supported Miracast Devices	74
Considerations for Deploying and Commissioning Miracast	74
Troubleshooting Miracast Connection Issues	74
Wireless Conferencing	76
Requirements	76
Peripherals	76
AirMedia Connect Adaptor	77
Supported Meeting Applications	77
User Experience	77
Selecting Peripherals	79
AirMedia Canvas	80
AirMedia Apps	83
AirMedia App for iOS Devices	83
AirMedia for AM-100 App for iOS Devices	83
AirMedia App for Android Devices	83
AirMedia for AM-100 App for Android Devices	83
Connect to AirMedia Devices with Mobile Applications	84
Test and Commission the AirMedia Presentation System	88
AirMedia Test Use Cases by User Experience	88
Front of Room Experience	88
PC User Experience Test Case Considerations	89
Mobile User Experience Test Case Considerations	89
Commission and Monitor AirMedia Devices	90

Overview

The AirMedia® device family allows users to present content and collaborate on displays by leveraging existing IT infrastructure. AirMedia devices allow users to replicate their entire display wirelessly with low latency and bandwidth consumption. All AirMedia devices are designed to ease deployment and management.

To compare AirMedia devices, refer to [Select the Right System on page 2](#).

When connecting to AirMedia devices, a connection is made to the local Wi-Fi® network with a Windows®, macOS®, iOS® or Android™ device and the corresponding AirMedia sender application. Windows and macOS users can quickly download an AirMedia sender application from the AirMedia device or have the AirMedia sender application installed by IT administrators. Chrome OS™ users can use the AirMedia extension to easily present web browser and desktop content. iOS and Android mobile devices can use the free apps available from the App Store® app on iOS and the Google Play™ store app on Android. AirMedia Series 3 and AirMedia 2.0 devices allow users to share full-screen Excel® spreadsheets, Word documents, PowerPoint® presentations, PDF files, on-device videos, photos, and other content in meeting spaces.

For more information on specific AirMedia devices and their capabilities, please refer to the following documents:

- [AirMedia® Series 3 Receivers Product Manual](#) (Doc 9020)
- [AM-200/AM-300 Product Manual](#) (Doc. 8254)
- [AM-101 Supplemental Guide](#) (Doc 7918)
- [AM-100 Operations Guide](#) (Doc 7463)
- [CCS-UC-1 Supplemental Guide](#) (Doc 7844)
- [DMPS3-4K-200-C/DMPS3-4K-300-C Series Supplemental Guide](#) (Doc 7849)
- [Crestron® PinPoint™ App Deployment Guide](#) (Doc 7976)

Select the Right System

AirMedia devices are offered in various models to meet a wide range of requirements. Refer to the following tables to determine which model fits your application.

AirMedia Series 3 Devices

FEATURE	DETAIL	AM-3100-WF(-I)	AM-3200	AM-3200-WF(-I)
Security	AES-128/TLS Security ¹	✓	✓	✓
	802.1X	✓	✓	✓
	Access Directory Authentication	✓	✓	✓
Crestron® Control Software	.AV Framework™ Software	✓	✓	✓
	XiO Cloud® Software	✓	✓	✓
	SIMPL Windows	✓	✓	✓
	SIMPL # Pro	Future release	Future release	Future release
	Crestron Studio® Software	N/A	N/A	N/A
	VC4	✓	✓	✓
AirMedia Device Support	PC-Windows® OS All Versions	✓	✓	✓
	Mac® Devices	✓	✓	✓
	iPad® Devices	✓	✓	✓
	iPhone® Devices	✓	✓	✓
	iOS Devices	✓	✓	✓
	Android Devices	✓	✓	✓

FEATURE	DETAIL	AM-3100-WF(-I)	AM-3200	AM-3200-WF(-I)
AirMedia Screen Mirroring Support	PC-Windows All Versions	✓	✓	✓
	Mac® Devices	✓	✓	✓
	iPad® Devices	✓	✓	✓
	iPhone® Devices	✓	✓	✓
	iOS Devices	✓	✓	✓
	Android Devices	✓	✓	✓
	Chromebook™ Computer and Chrome OS™ Operating System ²	✓	✓	✓
AirMedia Video + Audio Playback	PC-Windows All Versions	✓	✓	✓
	Mac® Devices	✓	✓	✓
	iPad® Devices	✓	✓	✓
	iPhone® Devices	✓	✓	✓
	iOS Devices	✓	✓	✓
	Android Devices	x	x	x
	Chromebook and Chrome OS (Support with audio is supported only for the active tab)	✓	✓	✓
AirMedia Protocol Support	AirPlay® Streaming	✓	✓	✓
	Miracast® Streaming	✓	x	✓
Integrated Technology	AirMedia Series 3 Technology	✓	✓	✓
	.AV Framework™ Platform	✓	✓	✓
	XiO Cloud Service Support	✓	✓	✓
Video Inputs	HDMI® Input	x	1	1
	HDMI Resolution	x	1080p60	1080p60
	HDMI HDCP	x	HDCP 1.4	HDCP 1.4
Video Outputs	HDMI Output	1	1	1
	HDMI Resolution	4K60	4K60	4K60
	HDMI HDCP	HDCP 2.2	HDCP 2.2	HDCP 2.2

FEATURE	DETAIL	AM-3100-WF(-I)	AM-3200	AM-3200-WF(-I)	
Other Interfaces	IR	x	✓	✓	
	RS-232	x	✓	✓	
	CEC	✓	✓	✓	
	Power over Ethernet (PoE+)	✓	✓	✓	
	Dual LAN	x	✓	✓	
Other Interfaces (continued)	WLAN Guest Access Point Mode	✓	x	✓	
Additional Features	AirMedia Canvas	✓	✓	✓	
	AirMedia Canvas Control	✓	✓	✓	
	AirMedia Application Downloads from Cloud/Server	✓	✓	✓	
	Appspace® Software ³	✓	✓	✓	
	Control System Interface	✓	✓	✓	
	AM-101 Compatibility Mode	x	x	x	
	AirMedia Series 3 Connection Experience	✓	✓	✓	
	YouTube® Push Mode Support	✓	✓	✓	
	Mounting	Freestanding	Freestanding	Freestanding	Freestanding
		Surface	Surface	Surface	Surface
		Rack	Rack	Rack	
Dimensions	Height: 1.21 in. (31 mm)	Height: 1.26 in. (33 mm)	Height: 1.26 in. (33 mm)	Height: 1.26 in. (33 mm)	
	Width: 5 in. (127 mm)	Width: 7.40 in. (188 mm)	Width: 7.40 in. (188 mm)	Width: 7.40 in. (188 mm)	
	Depth: 5 in. (127 mm)	Depth: 6.93 in. (177 mm)	Depth: 6.93 in. (177 mm)	Depth: 6.93 in. (177 mm)	

Notes:

1. TLS 1.3 is not currently supported.
2. The AirMedia Extension for Google Chrome relies on web technologies for screen sharing that are built into the web browser. Performance variations with motion video (quality and frame rate) may occur based upon the encoding capabilities of the Chrome OS device and the nature of the content being displayed (i.e., high motion video).
3. For best practices when configuring AirMedia Series 3 devices for use with Appspace software, please visit docs.appspace.com

AirMedia 2.0 Devices

FEATURE	DETAIL	AM-200 AM-300	DMPS3-4K-250-C	DMPS3-4K-350-C	CCS-UC-1 CCS-UC-1-X
Security	AES-128/TLS Security ¹	✓	✓	✓	✓
	802.1X	✓	✓	✓	✓
	Access Directory Authentication	✓	✓	✓	✓
Crestron Control Software	XiO Cloud [®] Software	✓	✓	✓	✓
	.AV Framework [™] Software	✓	✓	✓	✓
	SIMPL Windows	✓	✓	✓	✓
	SIMPL # Pro	✓	✓	✓	✓
	Crestron Studio [®] Software	N/A	N/A	N/A	N/A
	VC4	✓	✓	✓	✓
AirMedia Device Support	PC-Windows All Versions	✓	✓	✓	✓
	Mac [®] Devices	✓	✓	✓	✓
	iPad [®] Devices	✓	✓	✓	✓
	iPhone [®] Devices	✓	✓	✓	✓
	iOS Devices	✓	✓	✓	✓
	Android Devices	✓	✓	✓	✓

FEATURE	DETAIL	AM-200 AM-300	DMPS3-4K-250-C	DMPS3-4K-350-C	CCS-UC-1 CCS-UC-1-X
AirMedia Screen Mirroring Support	PC-Windows All Versions	✓	✓	✓	✓
	Mac® Devices	✓	✓	✓	✓
	iPad® Devices	✓	✓	✓	✓
	iPhone® Devices	✓	✓	✓	✓
	iOS Devices	✓	✓	✓	✓
	Android Devices	✓	✓	✓	✓
	Chromebook™ Computer and Chrome OS™ Operating System ²	✓	Future release	Future release	✓
AirMedia Video + Audio Playback	PC-Windows All Versions	✓	✓	✓	✓
	Mac® Devices	✓	✓	✓	✓
	iPad® Devices	✓	✓	✓	✓
	iPhone® Devices	✓	✓	✓	✓
	iOS Devices	✓	✓	✓	✓
	Android Devices	✗	✗	✗	✗
	Chromebook and Chrome OS (Support with audio is supported only for the active tab)	✓	Future release	Future release	✓
AirMedia Protocol Support	AirPlay® Streaming	✓	✓	✓	✓
	Miracast® Streaming	✓	✗	✗	✓
Integrated Technology	AirMedia 2.0 Technology	✓	✓	✓	✓
	.AV Framework™ Platform	✓	✓	✓	✓
	XiO Cloud Service Support	✓	✓	✓	✓

FEATURE	DETAIL	AM-200 AM-300	DMPS3-4K-250-C	DMPS3-4K-350-C	CCS-UC-1 CCS-UC-1-X
Video Inputs	HDMI® Input	1	6	6	1
	HDMI Resolution	1080p	4k60@420	4k60@420	1080p
	HDMI HDCP	HDCP 1.4	HDCP 2.2	HDCP 2.2	HDCP 1.4
	4K DigitalMedia™ Input	1 (AM-300 only)	1 (4K)	2 (4K)	✘
	4K DM® Resolution	4k60 4:2:0 (AM-300 only)	4k60@420	4k60@420	✘
	4K DM HDCP	HDCP 2.2 (AM-300 only)	HDCP 2.2	HDCP 2.2	✘
Video Outputs	HDMI Output	✓	✓	✓ (x2)	✓
	HDMI Resolution	AM-200: 1080p AM-300: 4k30	4k60@420	4k60@420	1080p
	HDMI HDCP	AM-200: HDCP 1.4 AM-300 HDCP 2.2	HDCP 2.2	HDCP 2.2	HDCP 1.4
Other Interfaces	IR	✓	✓	✓	✓
	RS-232	✓	✓	✓	✓
	CEC	✓	✓	✓	✓
	Power over Ethernet (PoE/PoE+)	AM-200: ✓ AM-300: ✘	✘	✘	✓ (PoE+, CCS-UC-1 only)
	Dual LAN	✘	✓	✓	✓ (CCS-UC-1 only)
Other Interfaces (continued)	WLAN Guest Access Point Mode	✓ ³	✘	✘	✘
UC Features	Speakerphone	✘	✘	✘	✓
	Bluetooth	✘	✘	✘	✓
	Microphone	✘	✘	✘	✓
Additional Features	AirMedia Canvas	✓	Future release	Future release	Future release

FEATURE	DETAIL	AM-200 AM-300	DMPS3-4K-250-C	DMPS3-4K-350-C	CCS-UC-1 CCS-UC-1-X
	AirMedia Canvas Control	✓	Future release	Future release	Future release
	AirMedia Application Downloads from Cloud/Server	✓	Future release	Future release	Future release
	Appspace® Software ⁴	✓	Future release	Future release	✓
	Crestron AirBoard™ Whiteboard Capture Device	✓	Future release	Future release	✓
	Kaptive® Whiteboard Capture Device	✓	Future release	Future release	✓
	Control System Interface	✓	✓	✓	✓
	AM-101 Compatibility Mode	AM-200: ✓ AM-300: ✗	✗	✗	✗
	AirMedia 2.0 Connection Experience	✓	Future release	Future release	✓
	Zūm® Sensors and/or Buttons	✓	✓	✓	✓
	YouTube® Push Mode Support	✓	✓	✓	✓
	Mounting	Freestanding Surface Rack	Freestanding Surface Rack	Freestanding Surface Rack	Tabletop

FEATURE	DETAIL	AM-200 AM-300	DMPS3-4K-250-C	DMPS3-4K-350-C	CCS-UC-1 CCS-UC-1-X
	Dimensions	AM-200: Height: 6.42 in. (163 mm) Width: 7.40 in. (188 mm) Depth: 1.35 in. (34 mm) AM-300: Height: 7.93 in. (201 mm) Width: 9.28 in. (236 mm) Depth: 1.36 in. (34 mm)	Height: 5.20 in. (133 mm) Width: 17.28 in. (439 mm) Depth: 15.75 in. (400 mm)	Height: 5.20 in. (133 mm) Width: 17.28 in. (439 mm) Depth: 15.75 in. (400 mm)	Height: 4.11 in. (105 mm) Width: 8.92 in. (227 mm) Depth: 12.74 in. (324 mm)

Notes:

1. TLS 1.3 is not currently supported.
2. The AirMedia Extension for Google Chrome relies on web technologies for screen sharing that are built into the web browser. Performance variations with motion video (quality and frame rate) may occur based upon the encoding capabilities of the Chrome OS device and the nature of the content being displayed (i.e., high motion video).
3. Requires the [AM-USB-WIFI](#) or [AM-USB-WF-I](#) AirMedia Wi-Fi USB Adapter (sold separately).
4. For best practices when configuring the AM-200/300 for use with Appspace software, please visit docs.appspace.com

AirMedia Devices

FEATURE	AM-100	AM-101
AirMedia 2.0 Technology	x	x
.AV Framework Platform	x	x
XiO Cloud Service Support	x	x
HDMI Input	x	x
DigitalMedia Input	x	x
HDMI Output	1	1
DigitalMedia Output	x	x
Dual Display Support	x	x
Touch Screen Support	Via programming only	Via programming only
Unified Communications	x	x
Zūm Sensors and/or Buttons	x	x
COM/IR Support	x	x
PoE	x	x
Appspace	x	x
Crestron AirBoard	x	x
Quad View	x	✓
Remote View	x	✓
Moderator Mode	x	✓
Control System Interface	x	✓
YouTube Push Mode Support	x	x
Dual LAN	x	x
Mounting	Freestanding	Freestanding
	Surface	Surface
Dimensions	Height: 1.10 in. (28 mm)	Height: 1.10 in. (28 mm)
	Width: 6.15 in. (156 mm)	Width: 6.15 in. (156 mm)
	Depth: 2.39 in. (61 mm)	Depth: 2.39 in. (61 mm)

AirMedia Network Infrastructure and Security

AirMedia leverages existing IT network infrastructure and policies. It contains a single-wired network interface with no wireless interfaces or bridges in the device. AirMedia becomes a wireless solution by utilizing the existing wireless network in the deployed network infrastructure.

NOTE: The DMPS3-4K-250-C, DMPS3-4K-350-C, CCS-UC-1, AM-3200, AM-3200-WF, and AM-3200-WF-I have two LAN ports. The administrator can specify which port is used for AirMedia in the device's AirMedia configuration screen shown in [Device Configuration on page 21](#).

All policies, encryption, and other implemented security measures are applied to AirMedia because AirMedia data is identical to standard Ethernet traffic. AirMedia traffic on the corporate network is treated like any other streaming network traffic. All existing policies that apply to physical network devices, such as switches or routers, also apply to AirMedia. AirMedia is a standard network appliance and is as secure as the supporting network.

AirMedia employs a proprietary protocol to transport the screen data to the device. In Windows, the quality slider in the setting limits the peak bandwidth only, not the average or minimum bandwidth, and behaves logarithmically rather than linearly.

When using native mirroring in macOS and iOS with AM-101, AirMedia 2.0 devices, and AirMedia Series 3 devices, the OS negotiates and controls the bandwidth to the AirMedia device due to the way the native mirroring protocol is defined. Official numbers are not published for minimum and maximum required bandwidth, but observed minimum and maximum numbers are similar to the AirMedia 2.0 and AirMedia Series 3 proprietary protocol. These numbers depend largely on the type and complexity of content displayed.

Crestron recommends upgrading all AirMedia devices to the latest firmware to ensure optimal network performance.

For information on bandwidth requirements, refer to [AirMedia Bandwidth Requirements on page 12](#).

AirMedia Bandwidth Requirements

TECHNOLOGY	Minimum	Typical	Maximum
AirMedia Series 3	0.25 Mbps	1.4 Mbps	8.5 Mbps
AirMedia 2.0	0.25 Mbps	1.4 Mbps	8.5 Mbps
macOS and iOS native device mirroring to AirMedia Series 3, AirMedia 2.0, and AM-101	Similar to AirMedia 2.0	5 Mbps	Similar to AirMedia 2.0
AM-100 & AM-101	0.5 Mbps	1.5 Mbps	15 Mbps
AM-100 (Old Firmware)	<0.1 Mbps	32 Mbps	46 Mbps

NOTE: The AirMedia bandwidth requirements are based on single-user presentations. The required bandwidth may increase during multi-user presentations.

Network Infrastructure and Design Considerations

Prior to deploying AirMedia products, assess the network infrastructure and design.

As the [AirMedia Bandwidth Requirements on page 12](#) table shows, AirMedia connection average bandwidth varies between devices and their firmware versions. The default peak bitrate in the Windows sender is 5 Mbps to ensure a high-quality experience for all types of content and a high frame rate at any resolution up to 1080p at 30 frames per second.

The peak bitrate target can be lowered to 1 Mbps on Windows senders, which is adequate for most static content types. 1080p video with high motion and detail levels, or complex motion with high foreground-background contrast such as smoke and flames, may not display in high quality at the lowest bitrates. This is due to the limitations of live video encoding and decoding on current devices. If this type of video content is played consistently, a higher bandwidth quality setting is recommended.

AirMedia Series 3 and AirMedia 2.0 devices are designed for lower latency than the AM-101. A latency of 150 ms has been observed when a single user presents in a well-designed and properly provisioned network with ideal Wi-Fi network conditions. Multi-user presentations will result in a higher latency. It is difficult to specify latency due to variations in network environments. For example, if high CPU-load applications are running in the background, then the wireless presentation experience may be affected.

To ensure proper bandwidth provisioning, low latency, and consistent performance, consider the following:

NOTES: The following techniques do not make up a complete list of possible issues. The techniques are included to give guidance in minimizing disruption of the AirMedia experience for end users and administrators.

- Manage wireless network infrastructure correctly.
- Design the network architecture between the AirMedia sender and receiver correctly.
- Minimize the impact of non-AirMedia device network traffic on the network.

Proper wireless access point design is essential for a successful AirMedia installation. While most access point vendors offer specific network design guidance, the following considerations may help prevent issues at scale:

- Bandwidth requirements per access point for all use types, including AirMedia, versus the available bandwidth the access point and non-overlapping Wi-Fi channels provide.
- Placement of wireless access points both on and between floors of a building so that co-channel interference is minimized. Using different antenna types and mounting locations can assist in minimizing interference by design.
- Capabilities of the radios of the most commonly used connecting devices. Use 2.4 GHz and 5 GHz bands and newer technologies such as 802.11ac whenever possible. 5 GHz bands have more channels and capacity than 2.4 GHz, though not all devices support both bands. Additionally, 5 GHz devices can have more a limited range through walls and objects than 2.4 GHz devices.
- Minimize the use of unmanaged and unwanted wireless devices via corporate policies and control of Wi-Fi network device access.
- Conduct a wireless survey with calibrated equipment to understand coverage overlaps and holes, appropriate access point power levels, and channel bandwidths.

Most wireless equipment vendors have authorized design and survey service providers which should be used whenever possible.

Proper network architecture between the sender and AirMedia device is necessary. Some considerations include:

- Minimize the number of network hops from the wireless access point to the AirMedia device.
- Use high-quality, non-blocking switches and routers with sufficient capability to move unicast streaming traffic from senders to AirMedia devices.
- Avoid scheduling processor-intensive or network-intensive applications, such as backup and software upgrades, in the background while the AirMedia sender is active.

Minimizing traffic from non-AirMedia devices can be challenging due to end user expectations on wireless networks. There are several techniques to help ensure AirMedia traffic is prioritized:

- Keep AirMedia devices and traffic on their own VLANs and subnet, and keep the devices routable from outside.
- Use quality-of-service features on switches and routers to prioritize AirMedia traffic as per the ports listed in [Firewall Settings & Port Table on page 25](#).
- Conduct network traffic flow analysis to identify network hot spots around the AirMedia device.

If Bonjour® or multicast DNS services are to be blocked, the blocking needs to occur at the switch level. If blocking occurs on a macOS or iOS sending device due to administrative policy regarding firewall settings, the native mirroring connection to AirMedia receivers will not be possible without the AirMedia app. Some organizations manage mDNS and Bonjour on their network using specialized management tools that minimize broadcast chatter while still providing services. These tools can occasionally interfere with device discovery and should be configured to prevent such interference.

Disable Discovery via Multicast DNS Services

If the IT department requires multicast DNS services to be turned off, AirMedia discovery by AirMedia applications can be disabled on the AirMedia Series 3, AM-200, and AM-300 devices.

For instructions on disabling AirMedia discovery on an AirMedia Series 3 receiver, refer to the [AirMedia Series 3 Receivers Product Manual](#) (Doc 9020).

For instructions on disabling AirMedia discovery on an AM-200 or AM-300, refer to the [AM-200/AM-300 Product Manual](#) (Doc. 8254).

NOTE: Disabling AirMedia discovery only disables AirMedia device discovery by AirMedia sender applications. Application users will have to manually input the address of the AirMedia receiver.

To disable all discovery functions related to Multicast DNS services, the Miracast feature should also be disabled as Miracast leverages Multicast DNS services. When disabled, users will not be able to present with Miracast.

For instructions on disabling Miracast on an AirMedia Series 3 receiver, refer to the [AirMedia Series 3 Receivers Product Manual](#) (Doc 9020).

For instructions on disabling Miracast on an AM-200 or AM-300, refer to the [AM-200/AM-300 Product Manual](#) (Doc. 8254).

Deployment Options for Guest Network Access

VLAN

In meeting rooms, guests may want to present to corporate users. In this scenario, guest and corporate networks may need to be kept separate even though users need to share a display. As a standard network device, AirMedia solves this problem by using standard networking practices. There are multiple recommended methods: a VLAN, a physical air gap, guest wireless access point mode, or the dual LAN interface (AirMedia Series 3 receivers only).

VLAN

In this scenario, AirMedia devices are placed in their own VLAN. This VLAN is configured to allow only incoming connections. Outbound traffic is not allowed. The guest and corporate networks exist in separate VLANs. Since outbound connections are not allowed, the guest VLAN cannot access the corporate VLAN through the AirMedia VLAN.

NOTE: When AirMedia devices are placed in their own VLAN, only incoming TCP connections are accepted by the device.

AirMedia VLAN-Based Method Example

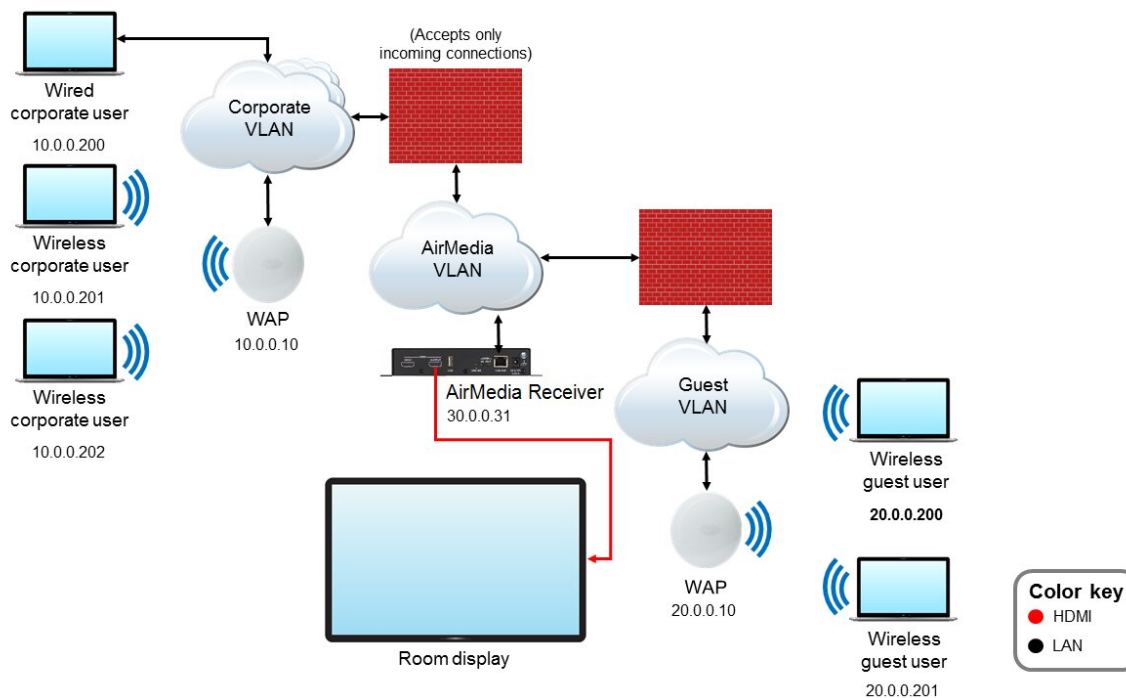

Physical Air Gap

If networks require some type of physical separation for security purposes, there are two approaches when using current AirMedia devices:

- With devices such as the AM-3100-WF that have a single network interface. In this case, two AirMedia devices can be used, one for corporate users and one for guest users.
- To switch presentations in the HDMI interface domain, use an HDMI switch such as the DMPS3-4K-250-C or DMPS3-4K-350-C. While secure, this approach requires more hardware.

AirMedia Physical Air Gap Method Example

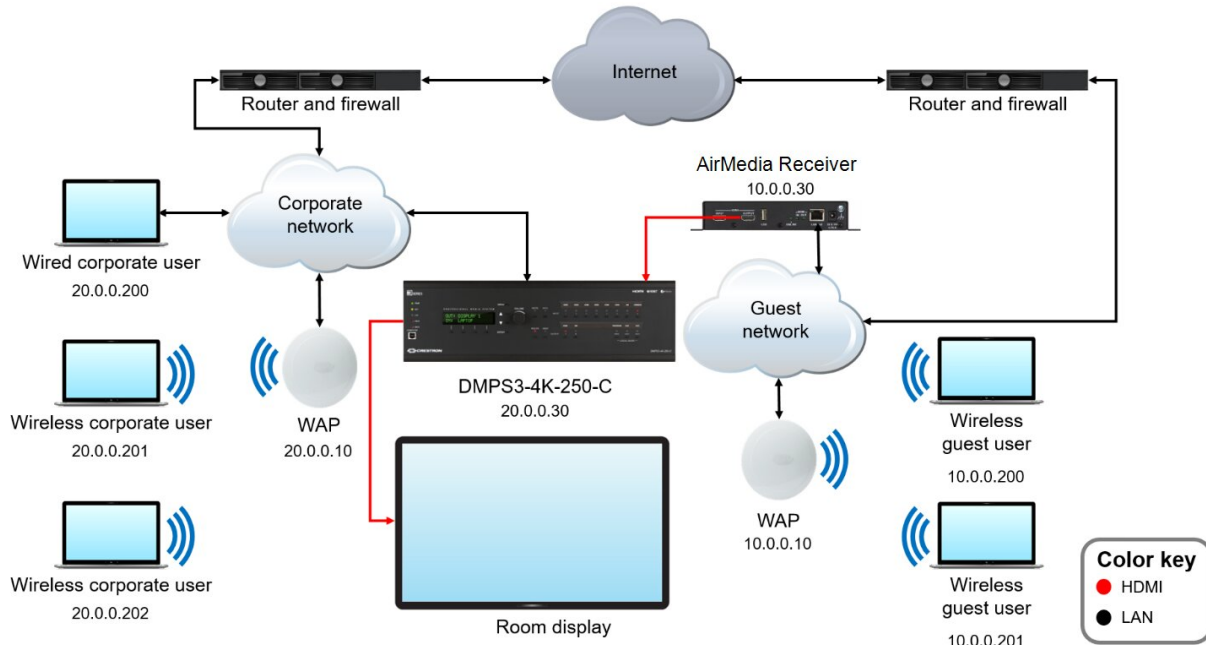

Guest Wireless Access Point Mode

Certain AirMedia devices can act as guest wireless access points that are isolated from the corporate network. This allows users connecting via the AirMedia sender application for Windows, Android, Mac, and iOS to present wirelessly.

AirMedia Series 3 Receivers

Wi-Fi network capable AirMedia Series 3 receivers can act as guest wireless access points.

NOTE: The AM-3200 cannot operate as a guest wireless access point.

AirMedia Wireless Access Point Mode Example (AirMedia Series 3)

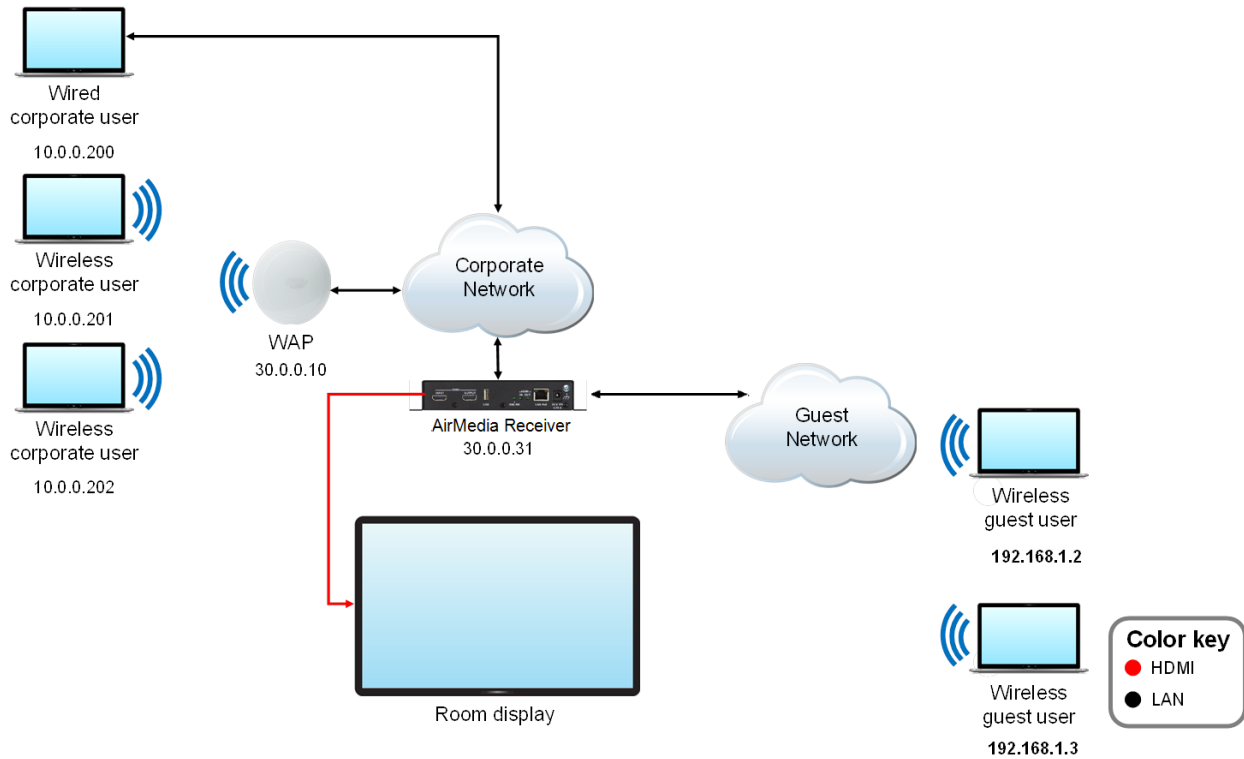

NOTES:

- The AirMedia app for ChromeOS cannot connect to the AirMedia Series 3 receivers through the guest wireless access point.
- Miracast users should not connect to the wireless access point. If the Miracast user connects to the access point first, the connection will fail. For details on connecting to an AirMedia receiver with Miracast, refer to [Miracast on page 73](#).

For instructions on enabling wireless access point mode on an AirMedia Series 3 receiver, refer to the [AirMedia Series 3 Receivers Product Manual](#) (Doc. 9020).

AM-200 and AM-300

The AM-200 and AM-300 can use the [AM-USB-WF](#) or [AM-USB-WF-I](#) AirMedia Wi-Fi network USB Adapter (sold separately) as a guest wireless access point.

AirMedia Wireless Access Point Mode Example (AirMedia 2.0)

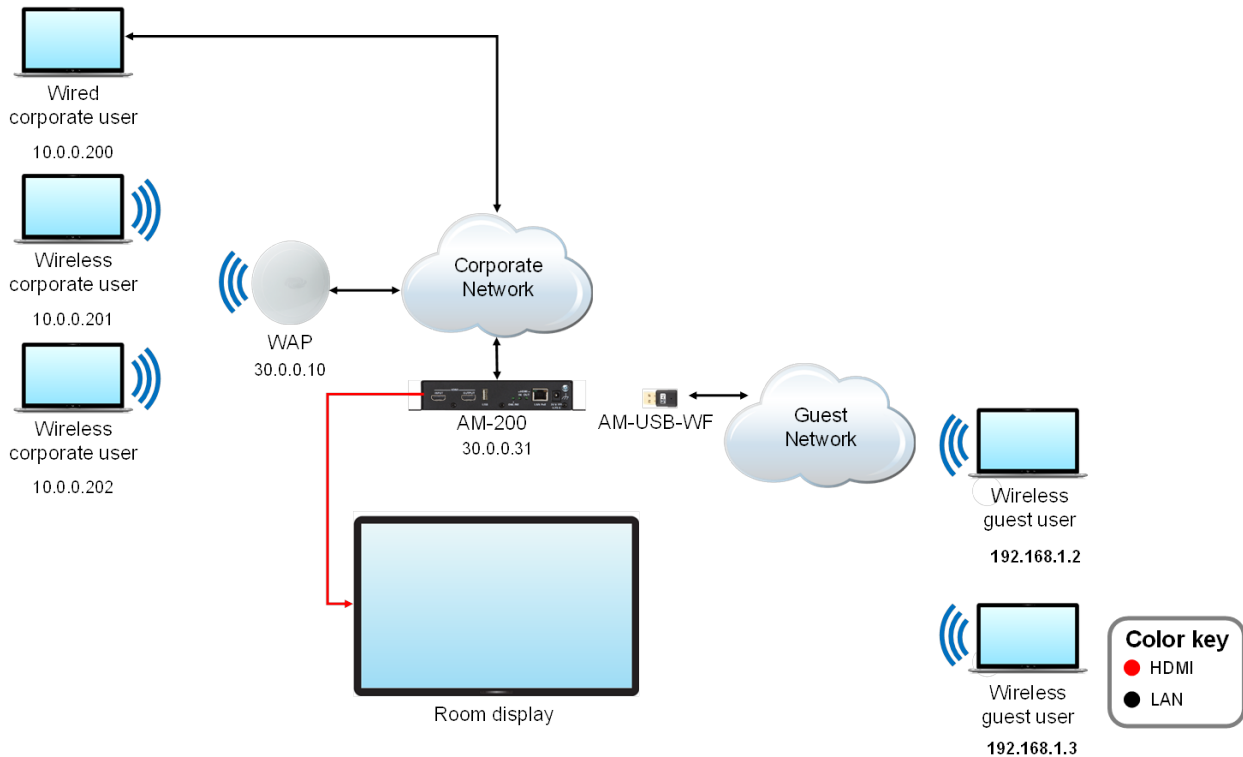

NOTES:

- The AirMedia app for ChromeOS cannot connect to the AM-200 or AM-300 through the guest wireless access point.
- Miracast users should not connect to the wireless access point. If the Miracast user connects to the access point first, the connection will fail. For details on connecting to an AM-200 or AM-300 with Miracast, refer to [Miracast on page 73](#).

For instructions on configuring the AM-200 or AM-300 as a guest wireless access point, refer to the [AM-200/AM-300 Product Manual](#) (Doc. 8254).

Dual LAN Interface (AirMedia Series 3 Only)

AirMedia Series 3 Receivers (AM-3200 and AM-3200-WF(-I) models only) provide dual LAN connectivity for isolated corporate and guest networks. Users may present via AirMedia when connected to either network.

For more information on dual LAN functionality, refer to [Dual LAN Functionality](#) in the [AirMedia Series 3 Receivers Product Manual](#) (Doc. 9020).

AirMedia Dual LAN Example (AirMedia Series 3)

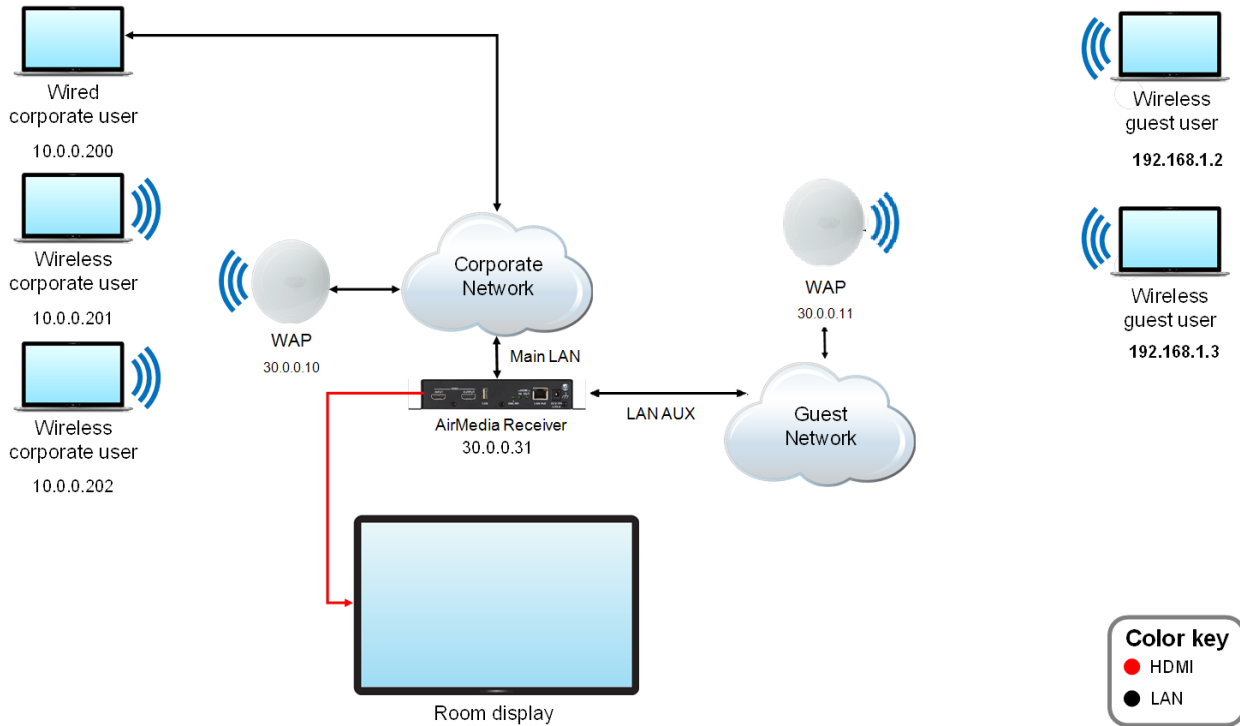

NOTE: The AirMedia app for ChromeOS cannot connect to the AirMedia Series 3 receivers through the guest wireless access point.

Data Transport & Encrypted Communications

The data connection from the sender is encrypted and can only be decrypted by an authorized AirMedia device. In conjunction with wireless access point security, AirMedia content cannot be secretly eavesdropped by non-authorized parties. Correct operation of the security protocols is contingent on leaving the correct ports open for the AirMedia device at the network switch as shown in [Device Configuration on page 21](#).

The AirMedia receiver within the AirMedia Series 3, AM-200, AM-300, CCS-UC-1, and CCS-UC-1-X devices supports third party certificates for encrypting connections between the AirMedia sender applications for Windows and Android devices and the receiver.

The use of third party certificates for encrypting connections can be enabled and disabled in the configuration of the product.

Please refer to the product's manual for instructions on how to load a certificate onto the device. If no certificate exists, the system will default to using a self-signed certificate.

- [AirMedia® Series 3 Receivers Product Manual](#) (Doc. 9020)
- [AM-200/AM-300 Product Manual](#) (Doc. 8254)
- [CCS-UC-1 Supplemental Guide](#) (Doc. 7844)

The AirMedia sender applications for Windows and Android can validate the use of a trusted certificate when making a connection.

AirMedia Device Considerations

Device Naming

To avoid confusion when entering an IP address, Crestron recommends each AirMedia device be given a host name that is easy for the user to remember. The IP address can be hidden from the on-screen display to limit the amount of information presented to the user. Crestron has implemented the following automated ways of resolving a device by host name:

- DHCP options 12 and 81
- NSUPDATE for dynamic DNS servers
- Bonjour and Multicast DNS

Crestron recommends configuring either a static IP or a DHCP reservation for the IP address as well as a DNS entry for the AirMedia device. Once the host name is configured, the IP address display can be turned off in the AirMedia web pages.

NSUPDATE is sent under the following conditions:

- If the device is using a static address and the DNS field is populated
- If the device is using DHCP to obtain an IP address, and the Domain Name field in the Network Setup screen is not blank

NOTE: If the domain name field is blank, NSUPDATE is not sent.

Device Configuration

AirMedia is configured through the device's web configuration interface. AirMedia 2.0 devices may also be configured via the XiO Cloud service. Parameters such as the device's IP address, connections to control systems, and connections to Crestron Connected® devices are set with a web browser. The username and password of a new device should be changed when signing in for the first time. For AirMedia Series 3 and AirMedia 2.0 devices, Crestron recommends using Active Directory® credential management software.

AirMedia Screen (General Settings) for AirMedia Series 3 Receivers

The screenshot shows the 'AirMedia' settings page with the 'General Settings' tab selected. The settings are as follows:

- AirMedia:** (On)
- AirMedia Certificate:** (Off)
- Force Secure Landing Page (HTTPS):** (Off)
- AirMedia Discovery:** (On)
- AirMedia Canvas:** (On)
- Canvas Session Control:** (On)
- Source Types:** All, Network Only
- AirMedia Client Settings:**
 - Timeout:** 45

AirMedia Screen (Network Adapter) for AirMedia Series 3 Receivers

The screenshot shows the 'AirMedia' settings page with the 'Network Adapter' tab selected. The settings are as follows:

- LAN 1 - Main:** (On)
- LAN 2 - AUX:** (On)
- WLAN:** (Off)

AirMedia Screen for AM-200 and AM-300

AirMedia

AirMedia Enabled

AirMedia Certificate Disabled

Force Secure Landing Page (HTTPS) Disabled

AirMedia Discovery Enabled

AirMedia Canvas

Canvas Enabled

Canvas Session Control Enabled

Canvas Options

- All Sources Types
- Network Source Types Only

AirMedia Client Settings

Timeout 45

Code

Login Code Mode

- Disabled
- Random
- Use the following code

Login Code

Display Login Code Enabled

Ethernet Adapter

Assigned Ethernet Port

- LAN
- WLAN

AirMedia Screen for DMPS3, CCS-UC-1, and CCS-UC-1-X

▼ Airmedia

Code

Login Code Mode Disabled
 Login Code Mode Random
 Login Code Mode Use the following code

Login Code

Ethernet Adapter

Assigned Ethernet Port Adapter 1
 Assigned Ethernet Port Adapter 2

Device Administration Screen for AM-100 and AM-101

Device Administration
Network Setup
Logout

- System Status
- Device Setup
- Network Setup
- OSD Setup
- Change Password
- Firmware Upgrade
- Remote View Setup
- Reset to Default
- Reboot System

Host Name and Domain Name	Host Name	<input type="text" value="My-AirMedia"/>
	Domain Name	<input type="text"/>
Note: For maximum compatibility, host names less than 15 characters are recommended allow char: [0-9], [A-Z], [a-z], [-].		
IP Setup	<input checked="" type="radio"/> Obtain an IP address automatically <input type="radio"/> Use the following IP address	
	IP Address	<input type="text" value="192"/> . <input type="text" value="168"/> . <input type="text" value="100"/> . <input type="text" value="10"/>
	Subnet Mask	<input type="text" value="255"/> . <input type="text" value="255"/> . <input type="text" value="255"/> . <input type="text" value="0"/>
	Default Gateway	<input type="text" value="192"/> . <input type="text" value="168"/> . <input type="text" value="100"/> . <input type="text" value="10"/>
	DNS Server	<input type="text" value="192"/> . <input type="text" value="168"/> . <input type="text" value="100"/> . <input type="text" value="10"/>
Crestron Control System	IP Address or Hostname	<input type="text"/>
	IPID	<input type="text" value="05"/> ▼
	Communication Status	Offline
Crestron Connected™ Device	IP Address or Hostname	<input type="text"/>
	Communication Status	Offline
	CurrentSource	None
	Source	<input type="text" value="None"/> ▼ <input type="button" value="Set"/>
	Automatic Power On	<input checked="" type="radio"/> Immediately <input type="radio"/> After Code Entry
	Power Off Time Out	<input type="text" value="0"/> minutes <input type="button" value="Set"/>
	Power Control	<input type="button" value="Power On"/> <input type="button" value="Power Off"/>
	Power Status	Unknown
	Lamp Hours	0 hours
Device Status	No Error	
<input type="button" value="Apply"/> <input type="button" value="Cancel"/>		

24 • AirMedia® Presentation Gateway

Security Reference Guide — Doc. 7693AL

Firewall Settings & Port Table

The AirMedia sender application requires firewall rules to allow it to communicate with AirMedia devices. Crestron requires creating a rule for the AirMedia sender application that allows all traffic to pass to the device. If the rule is not created, the operating system prompts the user with the option to add a rule. This may require administrator privileges.

For a list of ports that allow the client to communicate with the device, refer to the following tables.

NOTE: AirMedia Series 3 receivers with a signage provider enabled will need access to <https://crestrondevicefiles.blob.core.windows.net/> over port 443 to download required installation files.

Port Map 1: Ports Used by AirMedia Series 3 Receivers (AM-3100-WF(-I), AM-3200, AM-3200-WF(-I))

Port	Type	Direction (Client)	Direction (Receiver)	Function	Open	Notes
22	Both	Both	Both	SSH/SFTP	Optional	This port is used for file transfer for configuration files/upgrades and text console configuration.
53	TCP	Outbound	Inbound	P2P Connection	Optional	This port provides captive portal functionality.
80	TCP	Both	Both	Web Access	Optional	This port is used for web configuration pages.
443	TCP	Both	Both	Web Access	Optional	This port is used for web configuration pages when SSL or a signage provider is enabled.
5353	UDP	Both	Both	Discovery	Optional	This port is used for AirMedia Presentation Gateway discovery. If this port is blocked, automatic network discovery will not function correctly.

Port	Type	Direction (Client)	Direction (Receiver)	Function	Open	Notes
6000-7000	TCP	Outbound	Inbound	Video	Required	These ports carry audio and video streams. If these ports are blocked, AirMedia will not function.
6000-8000	UDP	Both	Both	Audio	Required	These ports carry audio streams outbound from the client and control/QOS information outbound from the receiver. If these ports are blocked, AirMedia will not function.
7000	TCP	Outbound	Inbound	Control Channel	Required	This port carries control channel information. If this port is blocked, AirMedia will not function.
7011	TCP	Outbound	Inbound	Control Channel	Required	This port carries control channel information. If this port is blocked, AirMedia will not function.
7100	TCP	Outbound	Inbound	Control Channel	Required	This port carries control channel information. If this port is blocked, AirMedia will not function.

Port	Type	Direction (Client)	Direction (Receiver)	Function	Open	Notes
7200	TCP	Outbound	Inbound	Control Channel	Required	This port carries control channel information. If this port is blocked, AirMedia will not function.
7201	TCP	Outbound	Inbound	Control Channel	Required	This port carries control channel information. If this port is blocked, AirMedia will not function.
7236	TCP	Inbound	Outbound	Audio, Video	Recommended	Required if using Miracast. These ports carry audio and video streams.
7250	TCP	Outbound	Inbound	Control Channel	Recommended	Required if using Miracast. This port carries control channel information.
7300	TCP	Outbound	Inbound	Control Channel	Recommended	Required if using the AirMedia Google Chrome™ Extension*. This port carries control channel information.
7879	TCP	Both	Both	Control Channel	Recommended	Required if using an AirMedia Connect Adaptor. If this port is blocked, the AirMedia Connect Adaptor cannot be used.

Port	Type	Direction (Client)	Direction (Receiver)	Function	Open	Notes
7880	UDP	Inbound	Outbound	Control Channel	Recommended	Required if using an AirMedia Connect Adaptor. If this port is blocked, the AirMedia Connect Adaptor cannot be used.
8554	TCP	Outbound	Inbound	RTSP	Recommended	Required if using Wireless Conferencing. This port carries the conferencing peripheral stream.
9010-9020	UDP	Both	Both	Conferencing Channel	Recommended	Required if using Wireless Conferencing. These ports carry bidirectional messaging for conferencing sessions.
41794	TCP	Outbound	Inbound	Crestron over IP	Recommended	This port is used for Crestron control system connections.
41796	TCP	Outbound	Inbound	Secure Crestron over IP	Recommended	This port is used for secure Crestron control system connections.
47000	TCP	Outbound	Inbound	Control Channel	Required	This port carries control channel information. If this port is blocked, AirMedia will not function.

Port	Type	Direction (Client)	Direction (Receiver)	Function	Open	Notes
47010	TCP	Outbound	Inbound	Audio, Video	Required	This port carries audio and video. If this port is blocked, AirMedia will not function.
58887	TCP	Outbound	Inbound	Control Channel	Recommended	This port is for AirMedia canvas control. If this port is blocked, AirMedia canvas control will not function.

***NOTE:** The AirMedia Google Chrome Extension uses WebRTC based screen mirroring and may utilize other ports dynamically.

Port Map 2: Ports Used by AirMedia 2.0 Receivers (AM-200, AM-300, DMPS3, CCS-UC-1, CCS-UC-1-X)

Port	Type	Direction (Client)	Direction (Receiver)	Function	Open	Notes
22	Both	Both	Both	SSH/SFTP	Optional	This port is used for file transfer for configuration files/upgrades and text console configuration.
80	TCP	Both	Both	Web Access	Optional	This port is used for web configuration pages.
443	TCP	Both	Both	Web Access	Optional	This port is used for web configuration pages when SSL or a signage provider is enabled.

Port	Type	Direction (Client)	Direction (Receiver)	Function	Open	Notes
5353	UDP	Both	Both	Discovery	Optional	This port is for AirMedia Presentation Gateway discovery. If this port is blocked, automatic network discovery will not function correctly.
6000-7000	TCP	Outbound	Inbound	Video	Required	These ports carry audio and video streams. If these ports are blocked, AirMedia will not function.
6000-8000	UDP	Both	Both	Audio	Required	These ports carry audio streams outbound from the client and control/QOS information outbound from the receiver. If these ports are blocked, AirMedia will not function.
7011	TCP	Outbound	Inbound	Control Channel	Required	This port carries control channel information. If this port is blocked, AirMedia will not function.
7100	TCP	Outbound	Inbound	Control Channel	Required	This port carries control channel information. If this port is blocked, AirMedia will not function.

Port	Type	Direction (Client)	Direction (Receiver)	Function	Open	Notes
7200	TCP	Outbound	Inbound	Control Channel	Required	This port carries control channel information. If this port is blocked, AirMedia will not function.
7201	TCP	Outbound	Inbound	Control Channel	Required	This port carries control channel information. If this port is blocked, AirMedia will not function.
7236	TCP	Inbound	Outbound	Audio, Video	Recommended	Required if using Miracast. These ports carry audio and video streams.
7250	TCP	Outbound	Inbound	Control Channel	Recommended	Required if using Miracast. This port carries control channel information.
7300	TCP	Outbound	Inbound	Control Channel	Recommended	Required if using the AirMedia Google Chrome™ Extension*. This port carries control channel information.
41794	TCP	Outbound	Inbound	Crestron over IP	Recommended	This port is used for Crestron control system connections.
41796	TCP	Outbound	Inbound	Secure Crestron over IP	Recommended	This port is used for secure Crestron control system connections.

Port	Type	Direction (Client)	Direction (Receiver)	Function	Open	Notes
47000	TCP	Outbound	Inbound	Control Channel	Required	This port carries control channel information. If this port is blocked, AirMedia will not function.
47010	TCP	Outbound	Inbound	Audio, Video	Required	This port carries audio and video. If this port is blocked, AirMedia will not function.
58887	TCP	Outbound	Inbound	Control Channel	Recommended	This port is for AirMedia canvas control. If this port is blocked, AirMedia canvas control will not function.

***NOTE:** The AirMedia Google Chrome Extension uses WebRTC based screen mirroring and may utilize other ports dynamically.

Port Map 3: Ports Used by the AirMedia Windows Guest and Deployable Applications with the AM-100 and AM-101

Port	Type	Direction	Function	Open	Notes
80	TCP	Both	Projector Control	Optional	This port is used to turn on a Crestron Connected projector. If this port is blocked, the device functions normally, but the automatic projector power on feature does not work.
389 443 445	TCP	Both	Control Channel	Required	For best performance, Crestron recommends that ports 389, 443, and 445 be open. At a minimum, one port needs to be open for the device to function properly. If only one port is open and that port is used by another application, AirMedia will not function properly.

Port	Type	Direction	Function	Open	Notes
515	TCP	Both	Video	Required	This port is for the video data channel.
1041	TCP	Outbound	Control Channel	Required	If this port is not open, AirMedia does not function properly.
1047 1048 1049	UDP	Inbound	Discovery	Optional	These ports are used for device discovery. If the port is closed, AirMedia may not be able to find devices automatically.
1688	TCP	Both	Audio	Recommended	This port is for the audio data channel.
3268	TCP	Both	Control Channel	Required	This port is used as part of the screen sharing process.
7000	TCP	Both	Control Channel	Required	This port is used for client control of the device. If this port is closed, the AirMedia Presentation Gateway will not function correctly.
7100	TCP	Both	Control Channel	Required	This port is used for client control of the device. If this port is closed, the AirMedia Presentation Gateway will not function correctly.
7200 - 7201	TCP	Both	Control Channel	Required	This port carries control channel information. If this port is blocked, AirMedia will not function.
8080	TCP	Both	Video	Required	This port is for the video data channel. If the port is not open, AirMedia does not function properly.
19996	TCP	Both	Future	Optional	This port is reserved for future use.
31865	TCP	Both	Discovery	Optional	This port is used for device discovery. If this port is closed, AirMedia may not be able to find devices automatically.
47000	TCP	Both	Control Channel	Required	This port is used for client control of the device. If this port is closed, the AirMedia Presentation Gateway will not function correctly.

Port Map 4: Ports Used by AM-101 for macOS, iOS and Android full-screen mirroring

Port	Type	Direction	Function	Open	Notes
4100 - 4101	UDP	Both	Control Channel	Required	This port carries control channel information. If this port is blocked, AirMedia will not function.
5353	UDP	Both	Discovery	Optional	This port is for AirMedia Presentation Gateway discovery. If this port is blocked, automatic network discovery will not function correctly.
6000-7000	TCP, UDP	Both	Audio, Video	Required	These ports carry audio and video streams. If these ports are blocked, AirMedia will not function.
7011	UDP	Both	Control Channel	Required	This port carries control channel information. If this port is blocked, AirMedia will not function.
7200 - 7201	TCP	Both	Control Channel	Required	This port carries control channel information. If this port is blocked, AirMedia will not function.
47010	TCP	Both	Audio, Video	Required	This port carries audio and video. If this port is blocked, AirMedia will not function.

Port Map 5: Ports Used by the AirMedia Presentation Gateway (AM-100 and AM-101)

Port	Type	Direction	Function	Open	Notes
21	TCP	Both	Update Utility	Optional	This port is used only to transfer the firmware to the device with the batch update application. This port is not used when updating with the web interface.
80	TCP	Both	Web Services	Required	This port is used to access the AirMedia device configuration website.
137	TCP	Both	NetBIOS Discovery	Optional	This port allows the device to be resolved without a DNS server present. This port is enabled if the host name is fewer than 15 characters.
138	UDP	Both	NetBIOS Discovery	Optional	This port allows the device to be resolved without a DNS server present. This port is enabled if the host name is fewer than 15 characters.
41794	TCP	Both	Control System	Required	This port is used to control Crestron Connected devices.

Port	Type	Direction	Function	Open	Notes
42891 42892	TCP	Both	Update Utility	Required	These ports are used to control firmware updates and are used only with the batch update application. These ports are not used when updating the device with the web interface.

Device Upgrades

Single Device (Web Interface)

All AirMedia devices support firmware upgrades via their web interfaces. Use the web interface to upload a single file containing the firmware. Firmware upgrades may take 15 to 30 minutes to complete depending on the device and should be performed only outside of normal operating hours.

Multiple Devices

AirMedia 2.0 and AirMedia Series 3 device firmware can be upgraded through the XiO Cloud service. For details, refer to the [XiO Cloud Service User Guide](#) (Doc. 8214).

Crestron provides an application for upgrading multiple AirMedia devices (AM-100 and AM-101). The application reads room list files to simplify management. Devices can be upgraded one at a time, or in a batch operation. To upgrade AirMedia devices, the user needs to connect to an FTP server. The application provides an FTP server. AirMedia can also be configured to use an external FTP server. The application is available at present.crestron.com.

Control

AirMedia devices have multiple control options depending on the model and the specific needs of its location.

.AV Framework and XiO Cloud Service

AirMedia Series 3 and AirMedia 2.0 devices support .AV Framework functionality. .AV Framework provides a web interface to define inputs, outputs, and connected devices' standard behavior. Some of configurable settings include the ability to add Zūm space occupancy sensors and switches (AirMedia 2.0 only), TS- or TSW- series 7 in. or 10 in. touch screens, and controls for room displays. Other behaviors, such as scheduling a display device's power-on and power-off times, are also definable depending on the specific product and its capabilities.

With the XiO Cloud service, AirMedia devices provision settings stored in the cloud across an enterprise. The XiO Cloud service is also the central license management mechanism for devices such as DMPS3, CCS-UC-1, and CCS-UC-1-X which have transferrable AirMedia licenses and allow for seamless upgrades.

For instructions on configuring .AV Framework and the XiO Cloud service, refer to either the [AirMedia Series 3 Receivers Product Manual](#) (Doc. 9020) or the [AM-200/AM-300 Product Manual](#) (Doc. 8254).

NOTE: .AV Framework and the XiO Cloud service are not available on the AM-100 or AM-101.

Crestron Connected

AirMedia devices can control any Crestron Connected compatible display. When launching the application, a power on command is sent to the display, eliminating the need for a remote control or the press of a power button.

To use the Crestron Connected feature, the user provides the display's IP address or IP ID. When a user connects to the AirMedia device, a command is issued to turn on the display. After the last user disconnects from the AirMedia device, a command is issued to turn off the display.

For more information on Crestron Connected devices, refer to the Crestron Connected [compatible devices list](#).

Control System

AirMedia Series 3 devices can integrate with both Crestron 4-Series™ and 3-Series® control systems for complete room control. The AM-100, AM-101, AM-200, AM-300, and DMPS3 can integrate with Crestron 3-Series® control systems. When a Crestron control system is used, lights, display, HVAC, shading, and virtually any other device in the room can be controlled.

Additionally, when using an AM-100 or AM-101, the control system can implement Simple Network Management Protocol (SNMP) to integrate with existing IT management tools. The device parameters can be set and monitored by a Crestron control system as shown in the following table.

Device Parameters for AM-100/101

Name	Access	Type	Function
Status	Read	Analog	Reports the status of the device
Number of Users Connected	Read	Analog	Indicates the number of users currently connected
Device Access Code	Read	Analog	Sets the device access code
<p>NOTE: The input sets the current code and is only valid when the device code is in Fixed mode (configured through the device's web configuration).</p>			
Projector Connected	Read/Write	Analog	Reports the status of a connected projector Valid Values: 0 = Not connected 1 = Connected
Status Text	Read	Serial	Returns the status of the device as a string for display

Device Parameters Table (Type Column) Key for AM-100/101

Crestron Type	Standard Type
Digital	Boolean
Analog	16-bit integer
Serial	String (maximum length 255 bytes)

Crestron Fusion® software can also provide an alternative monitoring mechanism to SNMP. For more information on Crestron Fusion software, refer to crestron.com/fusion.

Deploy AirMedia Sender Applications to PCs

While PC users can download the AirMedia sender application for their operating system from an AirMedia device, IT departments can also deploy the AirMedia sender application to PCs across the enterprise.

Windows

The AirMedia Deployable application Windows installer is a Microsoft® Software Installer (.msi) file that provides the necessary control and flexibility for enterprise deployments.

The AirMedia Windows Deployable Application is available at present.crestron.com or from the corresponding AirMedia product page.

NOTES:

- A login for the Crestron website is required to access the deployable application from the product page.
- The AirMedia deployable sender application does not automatically update. To update the AirMedia sender application, uninstall any previous version of the AirMedia sender application and install the latest version using the method below. An account with administrative privileges must be used during installation.

The Windows installer can be run using one of the following methods:

- Microsoft Group Policy for mass deployment
- Windows command line
- A Group Policy Object (GPO) set up by an administrator to script the chosen installation the next time the user logs into their Windows system. When the .msi file is executed without any command line options, the default behavior is as follows:
 1. Install the AirMedia sender application in its default location (C:\Program Files (x86)\Crestron\AirMediaV2)
 2. Install desktop and Start menu shortcut icons
 3. Start automatically
 4. After installation, the connection information entry dialog box is presented. The dialog box is presented for users installing the AirMedia sender application for the first time without using any command line options

To use the installer with command line options, the `msiexec` function must be used in conjunction with the .msi file as specified below.

NOTE: If the .msi file is executed without using the `msiexec` application as shown, no options are respected at the command line, and the AirMedia sender application silently installs and presents the connection window for IP address or host name entry.

The general format for running the installer is as follows:

```
msiexec /I AirMedia_Windows_<VERSION>_deployable.msi /qn <OPTIONS>
```

- `/I`: The command line switch that tells `msiexec` to install the msi (required)
- `<VERSION>`: The version number of the deployable .msi file
- `/qn`: The command line switch that suppresses .msi dialogs
- `<OPTIONS>`: One or more of the following options, separated by spaces:
 - `INSTALLATIONMODE=--silent`: Suppresses the launching of the AirMedia sender application after installation is complete (the default behavior is to launch the AirMedia sender application)
When the option is silent and `/qn` is used, the installer will suppress any installer dialogs, and the AirMedia sender application will not be launched after installation
 - `INSTALLPATH=<PATH>`: Installs the AirMedia sender application in the specified path on the device rather than the default location
 - `SHORTCUTOPTION=<OPTION>`: Installs shortcuts according to one of four specified options:
 - `--none`: Installs no shortcuts
 - `--desktop`: Installs an application shortcut only to the desktop
 - `--menu`: Installs an application shortcut only to the Start menu
 - `--all`: Installs an application shortcut to both the desktop and the Start menu

Examples of .msi installation are as follows:

- `msiexec /I AirMedia_Windows_3.0.1.254_deployable.msi/qn INSTALLATIONMODE=--silent SHORTCUTOPTION=--menu`

This command installs the AirMedia sender application silently, without any dialogs or notifications, with only the Start menu shortcut installed, and without the AirMedia sender application starting after installation.

- `msiexec /I AirMedia_Windows_3.0.1.254_deployable.msi/qn INSTALLATIONMODE=--silent INSTALLPATH=D:\AirMedia`

This command installs the AirMedia sender application with desktop and Start menu shortcuts. It installs the application in a path not on the main Windows partition of the machine.

- `msiexec /I AirMedia_Windows_3.0.1.254_deployable.msi`

This command may be used to observe the behavior of the installer as it installs the AirMedia sender application to validate its operation visually.

NOTE: The Wireless Conferencing driver .msi can be deployed using the same method.

macOS

The macOS installer is a zip archive file that contains the AirMedia sender application as an executable to provide the ability to customize installations in enterprise deployments.

The deployable AirMedia sender application for macOS is available at present.crestron.com or from the corresponding product page.

NOTES:

- A login for the Crestron website is required to access the deployable AirMedia sender application from the product page.
- For AM-100 installations, the macOS installer should be used for sharing audio and video. The macOS installer has a user mode driver that is installed alongside the AirMedia sender application. The driver is not available with the guest AirMedia sender application version. For consistent functionality, the computer may require rebooting after installation.

Run the macOS installer in one of the following ways:

- Open the .zip archive file, and then run the installer file.
After installation, the sender application appears in the macOS dock and the /Applications/Crestron folder, and the sender application is launched. Upon installation, users will have a quick connection experience with easy access to the AirMedia sender application.
- For administrators, open the .pkg file within the installer to silently install the AirMedia sender application on users' machines. The sender application does not run after installation is completed, and the UI is not displayed. Inside the .pkg archive file is the InstallAirMedia.app bundle. The app bundle contains the required airmedia_osx_installer.pkg package file in the Content/Resources folder. On a terminal, issue the following command to run the installer:

```
sudo installer -pkg airmedia_osx_installer.pkg -target /
```

The AirMedia sender application can be installed silently (without user knowledge) on a macOS computer using Apple® policies, MDM, or other similar management tools. Options for installing desktop icons and specifying the installation location are not available due to the conventions of the macOS platform.

The deployable AirMedia sender application provides flexibility when managing AirMedia rooms with various levels of user access across multiple campus locations. To address various deployment scenarios, AirMedia provides the following methods to access a room's connection parameters:

- **Room Lists:** The AirMedia sender application reads an XML file containing a list of AirMedia rooms, then it displays the rooms on the **Connect** screen as a list of AirMedia devices that are available for connection.

NOTE: Room lists require a config.ini file and an XML file. For details on creating these files, refer to [Deployment and Configuration Options on page 43](#).

- **File Association:** The AirMedia sender application is associated with .present files and room list files. Embed the .present files in meeting invitations or host them on a corporate website.
- **Discovery:** If the AirMedia devices and the user's computer are on the same subnet, the AirMedia sender application locates these devices and presents them to the user. Crestron recommends this method if a room list or .present file is not used.

In macOS (and iOS), the AirMedia sender applications are not required if multicast DNS and/or Bonjour are not blocked on the network where AirMedia receivers reside. Multicast DNS and Bonjour allow a list of compatible native mirroring devices to appear in a list natively provided by the OS. However, the list can also contain a large number of non-Crestron discoverable gateways, making it difficult for users to search for and manage AirMedia devices. Additionally, users may not always be familiar with the procedure for connection via native mirroring. Crestron recommends using the AirMedia sender application for all connections from macOS and iOS.

NOTE: The AirMedia sender application must always be used with the AM-100. The AM-100 is not compatible with native device mirroring provided by macOS and iOS.

- **Manual Entry:** The AirMedia sender application allows the user to enter the host name or IP address of the AirMedia device.

Deployment and Configuration Options

When administrators deploy the AirMedia application to their organization's devices, they have the option to deploy configured application settings and/or a room list to streamline the end user experience.

Room lists can be used to maintain a list of AirMedia receivers on the network that will appear within the AirMedia application. This list can be easily searched without the need to enter an IP address or host name.

The Application Configuration file (Windows only) allows administrators to configure settings without requiring the end user to do so.

To implement room lists, two files must be prepared: a configuration file (config.ini) and an XML room list.

Windows File Deployment

On Windows PCs, configuration files can be deployed for every user or only specific ones. The files should be placed in the following locations:

- All Users: **C:\ProgramData\Crestron\AirMedia**
- Specific Users: **C:\Users\USERNAME\AppData\Roaming\Crestron\AirMedia Windows**

If these files are placed in both locations, the configuration and room list files in the User directory (AppData) will take precedence over the ProgramData directory. This allows for scenarios in which standard configurations are overwritten for specific users.

MacOS File Deployment

On macOS devices, the configuration files can be deployed to the following user directory:

/Users/USERNAME/Library/Containers/com.crestron.AirMedia2/Data/Library/Application Support/Crestron/AirMedia/Configure/

Configuration File (config.ini)

The config.ini file contains the location of the room list XML file. The file contains two items: the section (Crestron) and the key (XMLPath). An example of a config.ini file is shown below. Modify the path to reference the location of the room_list.xml file to be used.

```
[Crestron]
XMLPath=M:\config\airmedia\room_list.xml
```

When the AirMedia sender application starts, it attempts to read the file at the location specified by the XMLPath. Consider the following when specifying an XML path:

- Do not enclose the path in quotes.
- Environmental variables are not supported.
- When updates are necessary, a change applied to this file when it's administered locally or on the network will allow users quick access to the available AirMedia rooms.
- On Windows:
 - Local and network paths are allowed.
 - HTTP/HTTPS paths are allowed.
- On macOS:
 - Network paths are not allowed.
 - HTTP/HTTPS paths are allowed.
 - Certain local paths are allowed: Desktop, Documents, Applications, Downloads, Movies, Music, Pictures, Public or locally mapped cloud service directories such as the Dropbox, Google Drive, OneDrive, or iCloud services.

Room List (XML File) for Windows and macOS

The room list file is an XML file that defines the devices and their connection parameters. The specifics of the XML file schema are defined in the table below.

Room List File Details

Tag	Description
devices	The main container for the room list file. Each file must contain only one set of tags.
device	The container for each device to be displayed. The file may contain one or more set of tags.

Tag	Description
name	The display name for the AirMedia device that is shown in the Device Name column of the AirMedia sender application.
address	The IP address of the AirMedia device. This field is currently limited to IPv4 addresses only.
code	Limits access to AirMedia. The tag can be disabled, randomly generated, or fixed to a specific value. In fixed mode, the code tag may be used to specify the access code.

Example File

```
<?xml version="1.0"?>
<devices>
  <device>
    <name>Room 239</name>
    <address>192.168.0.184</address>
    <code>5885</code>
  </device>
  <device>
    <name>Room 240</name>
    <address>192.168.0.186</address>
  </device>
  <device>
    <name>Room 241</name>
    <address>192.168.0.186</address>
  </device>
</devices>
```

Application Configuration (XML File) for Windows

Application Configuration File (XML File) for Windows

Container	Parameter	Values	Description
startup	persistentSessionDelegation	3 = Deny 2 = Ask Me 1 = Auto Approve	Selects the Session Delegation option, which would typically be presented on the first-run screen when the app is initially launched. If this value is configured, the first-run screen will not appear.

Container	Parameter	Values	Description
startup	initial.install.setup	FIRST.INSTALL.PLACEHOLDER	Allows the administrator to accept the End User License Agreement. If this value is set, the End User License Agreement prompt will not be displayed to the end user.
startup	discovery.auto	true false	Enables or disables automatic discovery of receivers upon app launch.
startup	peripheral.driver.virtual.display	true false	Enables or disables the AirMedia Virtual Screen option in the screen sharing list. AirMedia Virtual Screen requires AirMedia Peripherals version 1.4 or later to be installed.
startup	force.crestron.audio.driver	true false	Enables or disables always using the Crestron audio driver for presentation (rather than the default PC audio driver), even if Conferencing is disabled or not started. Requires AirMedia Application version 5.10 or later and AirMedia Peripherals version 1.10 or later to be installed.

Container	Parameter	Values	Description
startup	keyboard.shortcuts	true false	Enables or disables keyboard shortcuts in the AirMedia application (Ctrl + S: Stop, Ctrl + P: Play / Pause, Ctrl + M: Mute). Requires AirMedia Application version 5.10 or later.
update	auto	true false	Enables or disables automatic updates of the application

Example File

```
<?xml version="1.0" encoding="utf-8"?>
<settings>
  <startup>
    <persistentSessionDelegation>1</persistentSessionDelegation>
    <initial.install.setup>FIRST.INSTALL.PLACEHOLDER</initial.install.setup>
    <discovery.auto>true</discovery.auto>
    <peripheral.driver.virtual.display>false</peripheral.driver.virtual.display>
  </startup>
  <update>
    <auto>false</auto>
  </update>
</settings>
```

File Association for Windows and macOS

The .present files contain the parameters used to start a connection. A web server can host these files, or the files can be deployed to folders within the user's computer. The installer makes the association.

The .present file uses the same format as the device section of the room list file.

To connect using file association, double-click a .present file to launch the AirMedia sender application. If prompted, enter the login code in the **Login** screen and select **OK**.

NOTE: If a Crestron Connected display is used, the display turns on automatically.

Discovery

If a room list file is not located when AirMedia opens, the AirMedia sender application scans the local subnet for connection devices. If only one device is located, the AirMedia sender application tries to

connect to that device. If multiple devices are located, the AirMedia sender application displays a list of connection devices. Select a device from the list and select **Connect**.

Connect Screen (macOS)

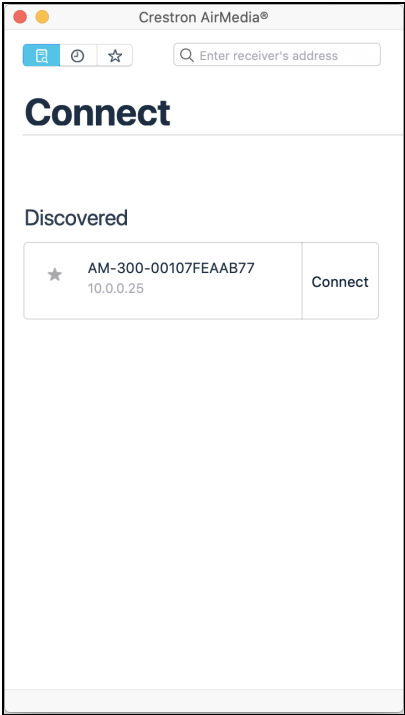

Manual Entry

If the AirMedia sender application is unable to discover any devices, the user can manually enter the information.

From the **Connect** screen, enter the host name or IP address of the device in the search box and press **Enter** on the keyboard. If a login code is required on the target device, the **Enter Code** screen displays.

Manually Entering Device Information (macOS)

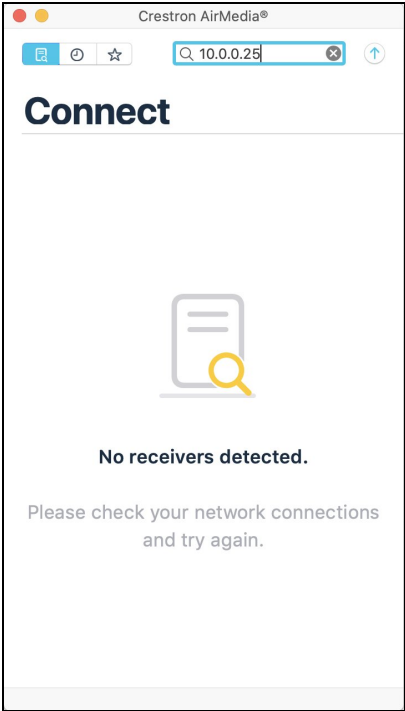

Custom URI Protocol

A custom web landing page may be built to accommodate an organization's receivers. When launching an installed application in a browser, the client-side script in the browser uses a custom protocol (crestron-airmedia) as defined by the DM Connections Method Specification. The rules for the custom protocol must follow the guidelines as defined by [RFC 3986: URI Generic Syntax](#).

There are two options to define the URI format for launching the application (Crestron recommends the first option):

1. crestron-airmedia://**receiver-address** [?code=**receiver-passcode**]
2. crestron-airmedia:**receiver-address** [?code=**receiver-passcode**]

receiver-address is the host name or address of the AirMedia receiver, and **receiver-passcode** is the optional passcode parameter for authorizing the mirroring session.

NOTE: To prevent unauthorized users from starting a mirroring session, the AirMedia landing page does not contain the passcode option. When designing a custom page, consider using the **receiver-passcode** parameter to address an institution's security needs.

AirMedia Sender Applications for User Download

When a user navigates to the address of an AirMedia device, they are presented with either the Windows or macOS AirMedia sender application as described in [Connection Experience on page 54](#). These sender applications are built into the device firmware.

On an AM-100, AM-101, DMPS, CCS-UC-1, or CCS-UC-1-X, updating the sender applications requires either updating the device's firmware or launching the application and selecting **Check for Update**.

On an AirMedia Series 3 device, AM-200, or AM-300, an administrator can configure where the receivers obtain the AirMedia sender applications for macOS or Windows by selecting one of the following options:

- **Off:** Provides the version that is included with the receiver's firmware.
- **Cloud Download:** Provides the latest version of the AirMedia application stored in the Cloud. The receiver checks for an update once a day at 2:00 am (local time). This method ensures that the device is providing the latest AirMedia sender application available to your users for download.
- **Remote Server:** Provides a version of the AirMedia application that is hosted on a remote server. When selected, enter the URL of the remote server in the **Server URL** field. This requires using the same Server URL set on all AirMedia receivers.

NOTE: If the setting is changed from **Cloud** or **Remote Server** to **Off**, the receiver will provide the application version that is included with the device's firmware (even if it is an older version than what is available in the cloud or the remote server).

Alternatively, a user can visit present.crestron.com for the latest AirMedia sender applications or select **Check for Update** within the AirMedia sender application.

Use AirMedia

Visitors to an AirMedia-equipped room are greeted with a welcome screen that provides instructions for connecting to an AirMedia device. AirMedia device users with a PC can use a web browser to download a guest AirMedia sender application from the device or use an installed version of the AirMedia sender application.

AirMedia users with a mobile device can use mobile apps for Android and iOS devices. For details, refer to [Connect to AirMedia Devices with Mobile Applications on page 84](#).

Welcome Screen

AirMedia devices show a welcome screen on a connected display device to convey the connection instructions for guest access. The welcome screen can also be configured to show custom login instructions and branding, as well as the host name, and IP address (optional) for the AirMedia device. AirMedia Series 3 receivers and the AM-200 and AM-300 can be configured to display Wi-Fi connection details.

AirMedia Welcome Screen for Series 3 Receivers

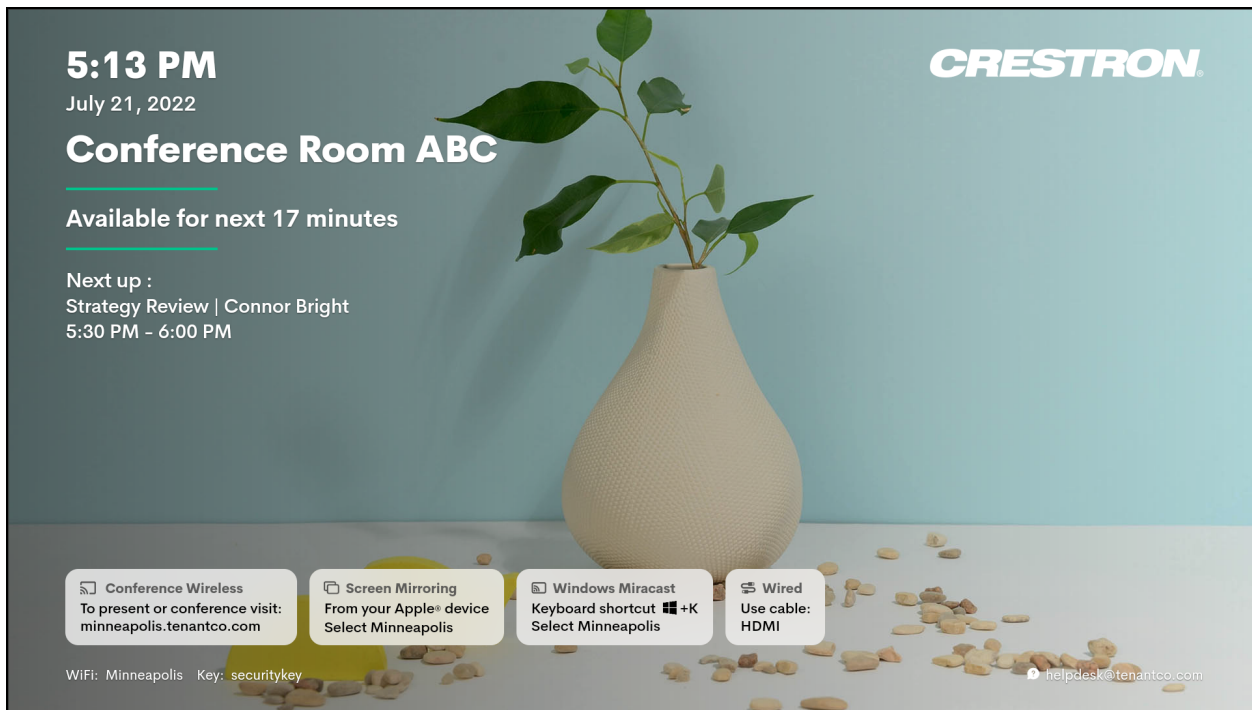



AirMedia Welcome Screen for AM-200, AM-300, DMPS3, CCS-UC-1, and CCS-UC-1-X

AVF 79253 June 11, 2020 | 2:30 PM



 Present Using Wireless
Visit: <http://192.168.1.1>
Code: 0066

 Present Using Cables
Connect using cables provided:



AirMedia Welcome Screen for AM-100 and AM-101

Address: <http://AirMedia-01f8b0> (192.168.0.12) Code: 5808

Find address here 



To begin your presentation, enter the address at the top of this screen into your web browser.

For mobile devices, download the free Crestron AirMedia app from the App Store® or Google Play™



All brand names, product names, and trademarks are the property of their respective owners. Certain trademarks, registered trademarks, and trade names may be used in this document to refer to other entities claiming the marks and names on their products. Crestron disclaims any proprietary interest in the marks and names of others. Crestron is not responsible for errors in typography or photography. ©2019 Crestron Electronics, Inc.

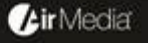

Connection Experience

The guest AirMedia sender applications for Windows or macOS may be downloaded from present.crestron.com, a device's built-in web page, or from the device's product page on the Crestron website (www.crestron.com).

Accessing the AirMedia device's built-in web page allows the user to download the guest AirMedia sender applications and automatically initiate a connection to the receiver. To initiate a connection this way, perform the following steps:

1. Open a web browser and enter the AirMedia device's IP address or host name into the address bar. The AirMedia web browser welcome screen is displayed.

Web Browser Welcome Screen

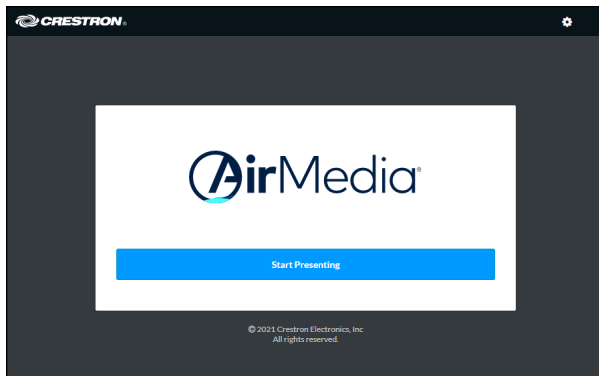

2. Select **Start Presenting**.

The built-in web page will automatically detect the type of device the user is trying to connect from, guide the user on how to connect, and where applicable, automatically launch and initiate a connection to the receiver. If a required AirMedia sender application is not already installed, the system will provide the installation for that particular device.

NOTE: AirMedia Series 3 receivers and the AM-200 and AM-300 can force connecting devices to a secure landing page (HTTPS). Toggle on the Force Secure Landing Page (HTTPS) setting in order to do so. When enabled, the web server uses either the certificate loaded in the certificate store (when available) or a self-signed certificate. When this setting is enabled, the AirMedia connection URL will contain HTTPS. For more information on enabling this setting, refer to either the [AirMedia Series 3 Receivers Product Manual](#) (Doc. 9020) or the [AM-200/AM-300 Product Manual](#) (Doc. 8254).

Login Code

A login code can be set to prevent unauthorized users from connecting to a device. When connecting to an AirMedia device with a code enabled, the code will pop up on the display. The user is prompted to enter the four digit code in the **Enter Code** dialog box.

Enter Code Dialog Box

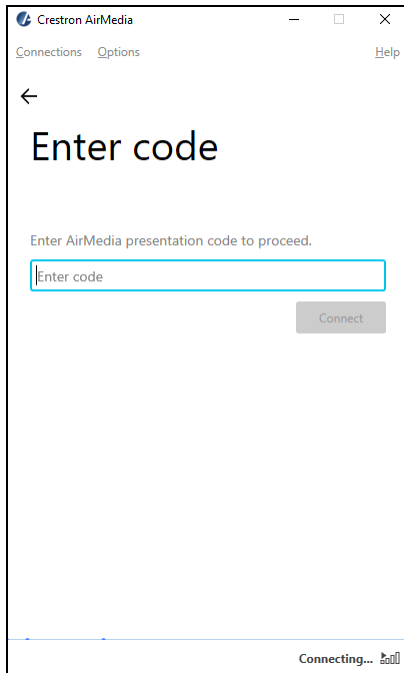

There are three modes of operation:

- **Disabled:** A login code is not required.
- **Random:** A login code is generated after all active users disconnect.
- **Fixed:** A static login code can be set in the web administration pages. It can also be programmed using a Crestron control system for AirMedia devices or via the XiO Cloud service on compatible devices.

NOTES:

- The **Fixed** setting should be selected for regular users who want to remember a login code. Otherwise, the **Random** setting is recommended to prevent unintended connections.
- Any changes to the login code will take effect when all senders are disconnected from the AirMedia receiver.

For information on setting the mode of operation, refer to the AirMedia device's product manual or supplemental guide.

PC Sender Applications

The AirMedia sender applications for Windows and macOS devices are the most common way for users to share content through an AirMedia receiver. There are two types of AirMedia sender applications available:

- **Guest Application:** Download the guest AirMedia sender applications for Windows or macOS from present.crestron.com, a device's built-in web page, or from the device's product page on the Crestron website.
- **Deployable Application:** Download the deployable AirMedia sender applications for Windows or macOS from present.crestron.com or from the device's product page on the Crestron website.

NOTE: For more information on connecting to AirMedia with a Windows or macOS device, refer to either [User Experience with Windows on page 56](#) or [User Experience with macOS on page 64](#).

The guest and deployable AirMedia sender applications are compatible with the following operating systems:

Operating System Compatibility Chart

Operating System	Versions Supported
Windows	Windows 8, Windows 8.1, and Windows 10
macOS	macOS version 10.12 or later

User Experience with Windows

This section provides information on the AirMedia user experience when using a Windows computer. The Windows guest AirMedia sender application is a small file downloaded from the AirMedia device and runs with standard user permissions. The IP address of the AirMedia device is encoded in the file name of the AirMedia sender application so the AirMedia sender application can connect to the AirMedia device upon startup. The user can save the AirMedia sender application locally to allow a direct connection to the device the next time the user accesses the AirMedia sender application.

AirMedia Guest Application on Windows

To use AirMedia presentation on a Windows computer, download the guest AirMedia sender application from the receiver and run the application on a computer.

On an AirMedia Series 3 or AirMedia 2.0 Device

To download the guest AirMedia sender application from an AirMedia Series 3 or AirMedia 2.0 device:

1. Open a web browser and enter the AirMedia device's IP address or host name into the browser. The web browser welcome screen is displayed.

Web Browser Welcome Screen

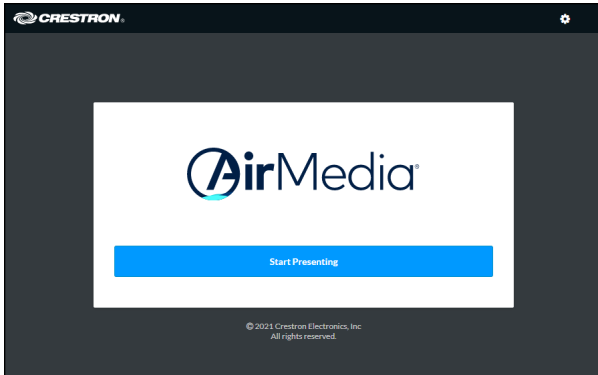

2. Select **Start Presenting**. The AirMedia download screen is displayed.

AirMedia Download Screen

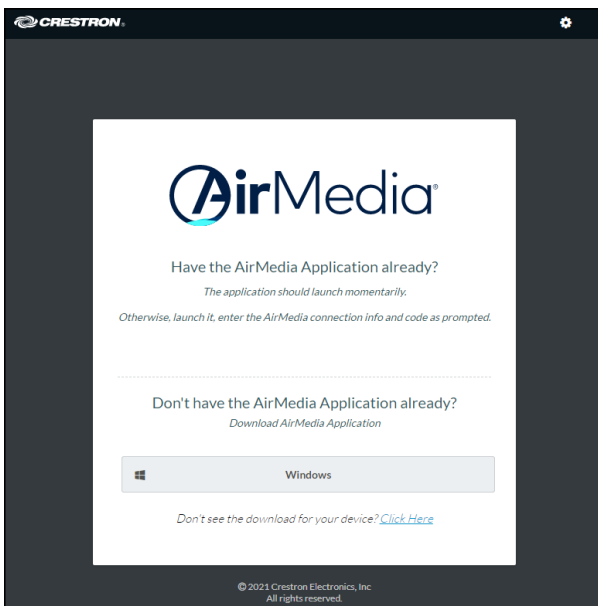

3. Select the **Windows** button to download the AirMedia software for Windows.

On an AM-100 or AM-101

To download the guest AirMedia sender application from an AM-100 or AM-101:

1. Open a web browser and enter the AirMedia device's IP address or host name into the address bar. The AirMedia download screen is displayed.

AirMedia Download Screen for AM-100 and AM-101

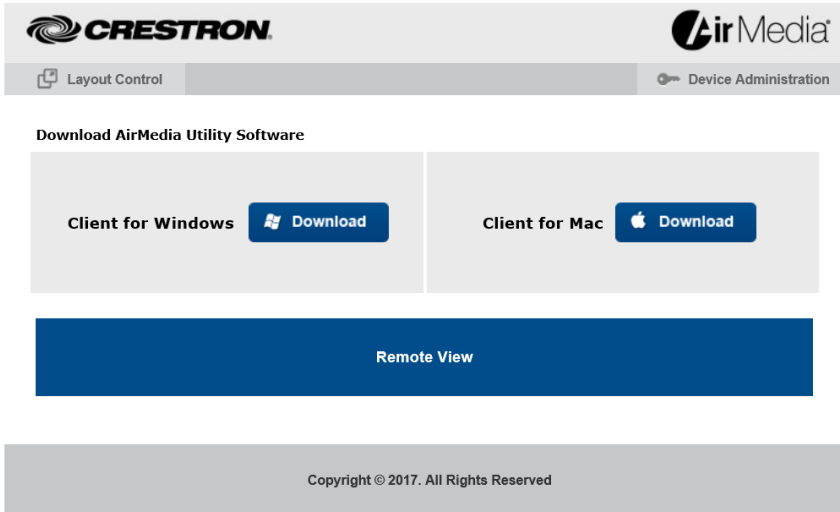

2. Select the **Download** button next to **Client for Windows**.

Use the Guest AirMedia Sender Application

To use the guest AirMedia sender application on a Windows computer:

1. Launch the guest AirMedia sender application. A list of devices appears if the Autodiscovery feature is enabled in the AirMedia sender application's settings. If a list does not appear, then navigate to **Connections** > **Discover** to detect devices.

Connect Dialog Box

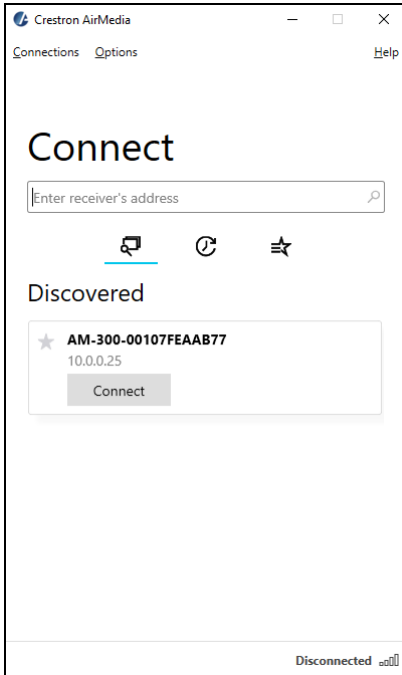

2. Choose the device to connect to, and then select **Connect**.

3. If prompted, enter the login code shown on the connected display and select **Connect**.

Enter Code Dialog Box

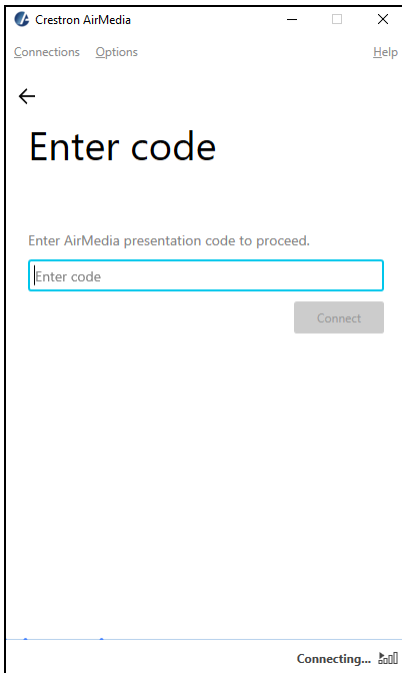

On an AM-100 or AM-101, if a Crestron Connected® display is connected and configured for operation, the display turns on automatically during this process.

The presentation session begins immediately following the entry of the code or, if no code is required, upon entry of the IP address or host name.

On AirMedia Series 3 and AirMedia 2.0 devices, other senders can connect and begin presenting. A maximum of 10 Windows or Android senders can connect simultaneously, although only the last device to connect will be able to present. If AirMedia Canvas is enabled on AirMedia 2.0 devices, then the last two devices to connect can present. If AirMedia Canvas is enabled on AirMedia Series 3 devices, then the amount of devices that can present is set in the device's web configuration interface. Previously connected senders that may be presenting are stopped. Other senders can restart a presentation by pressing the **Start** button in the AirMedia sender application.

For details on using the AirMedia sender application, refer to the AirMedia device's product manual or supplemental guide. For details on AirMedia Canvas, refer to [AirMedia Canvas on page 80](#).

NOTE: The guest AirMedia sender application for Windows can also be downloaded from present.crestron.com and distributed to websites or other media for users to download. The guest AirMedia sender application can be distributed with the connection parameters embedded in the file name so the user only has to enter the login code (if required).

The supported formats are:

`<any_text>_.<ip_address>.exe`

`<any_text>_<ip_address>.exe`

The underscore and dot must precede the IP address, for example: `executive_conference_room_.10.1.1.13.exe`.

AirMedia Deployable Application on Windows

To use the AirMedia deployable application on a Windows computer:

1. Launch the AirMedia deployable application. A list of devices appears if the Autodiscovery feature is enabled in the AirMedia sender application's settings. If a list does not appear, then navigate to **Connections > Discover** to detect devices.

NOTE: This list can also be populated with a room list file. For more information, refer to [Deployment and Configuration Options on page 43](#).

Connect Dialog Box

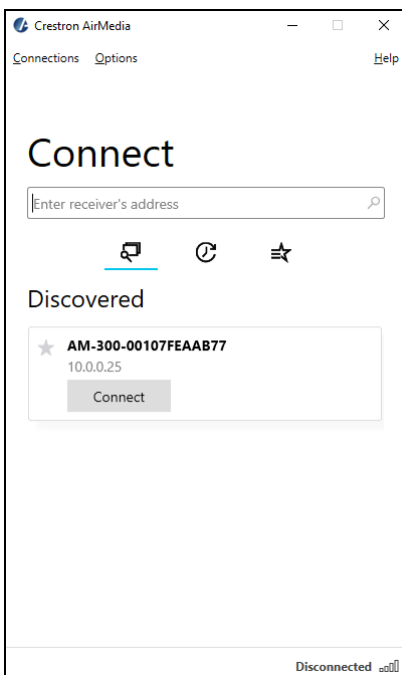

2. Choose the device to connect to, and then select **Connect**.

3. If prompted, enter the login code shown on the connected display and select **Connect**.

Enter Code Dialog Box

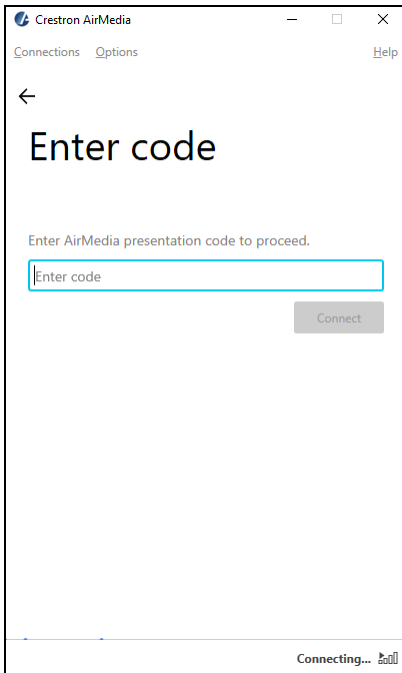

On an AM-100 or AM-101, if a Crestron Connected display is used, the display turns on automatically during this process. The presentation session begins immediately following the entry of the code or, if no code is required, upon entry of the IP address or host name.

On AirMedia Series 3 and AirMedia 2.0 devices, other senders can connect and begin presenting. A maximum of 10 Windows or Android senders can connect simultaneously, although only the last device to connect will be able to present. If AirMedia Canvas is enabled on AirMedia 2.0 devices, then the last two devices to connect can present. If AirMedia Canvas is enabled on AirMedia Series 3 devices, then the amount of devices that can present is set in the device's web configuration interface. Previously connected senders that may be presenting are stopped. Other senders can restart a presentation by pressing the **Start** button in the AirMedia sender application.

For details on using the AirMedia sender application, refer to the AirMedia device's product manual or supplemental guide. For details on AirMedia Canvas, refer to [AirMedia Canvas on page 80](#).

Launch with Automatic Connection

For custom deployments, the AirMedia sender application can also be configured to automatically connect with a device when launched. To automatically connect to a device on launch, use the following command in a Windows command prompt:

```
start present:<IP_ADDRESS>?code=<CODE>
```

where `<IP_ADDRESS>` is the IPv4 address of the AirMedia device and `<CODE>` is the login code for the AirMedia device.

Miracast® Presentation

Miracast technology allows users to share content wirelessly from a Microsoft Windows 10 device. Miracast technology is built into the Microsoft Windows 10 operating system, so no software

installation is required. This is an alternative to using the AirMedia sender application for Windows. Miracast presentation is currently supported on AirMedia Series 3 receivers and the AM-200, AM-300, CCS-UC-1, and CCS-UC-1-X devices.

NOTE: The AM-USB-WF or the AM-USB-WF-I wireless adapter is required when using Miracast with AirMedia 2.0 devices. For more information on Miracast, refer to [Miracast on page 73](#).

To use Miracast presentation:

1. Press the  (Windows) + **K** to display a list of nearby wireless devices.

Wireless Device List

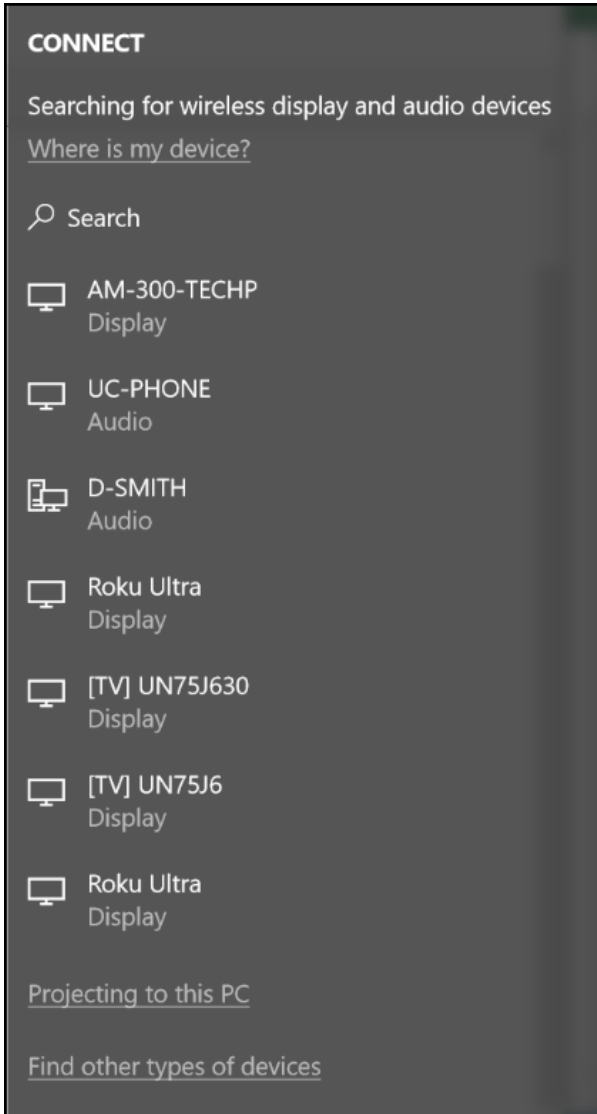

2. Select an AirMedia device to begin presenting.

3. Direct the presentation with the following controls:
 - Select **Disconnect** to disconnect from the device and end the presentation.
 - Select **Change projection mode** to choose how content is displayed.
 - Select **Duplicate** to show the screen on both the computer and the display.
 - Select **Extend** to split the screen between the computer and the display.
 - Select **Second screen only** to display the screen only on the display.

Miracast Controls

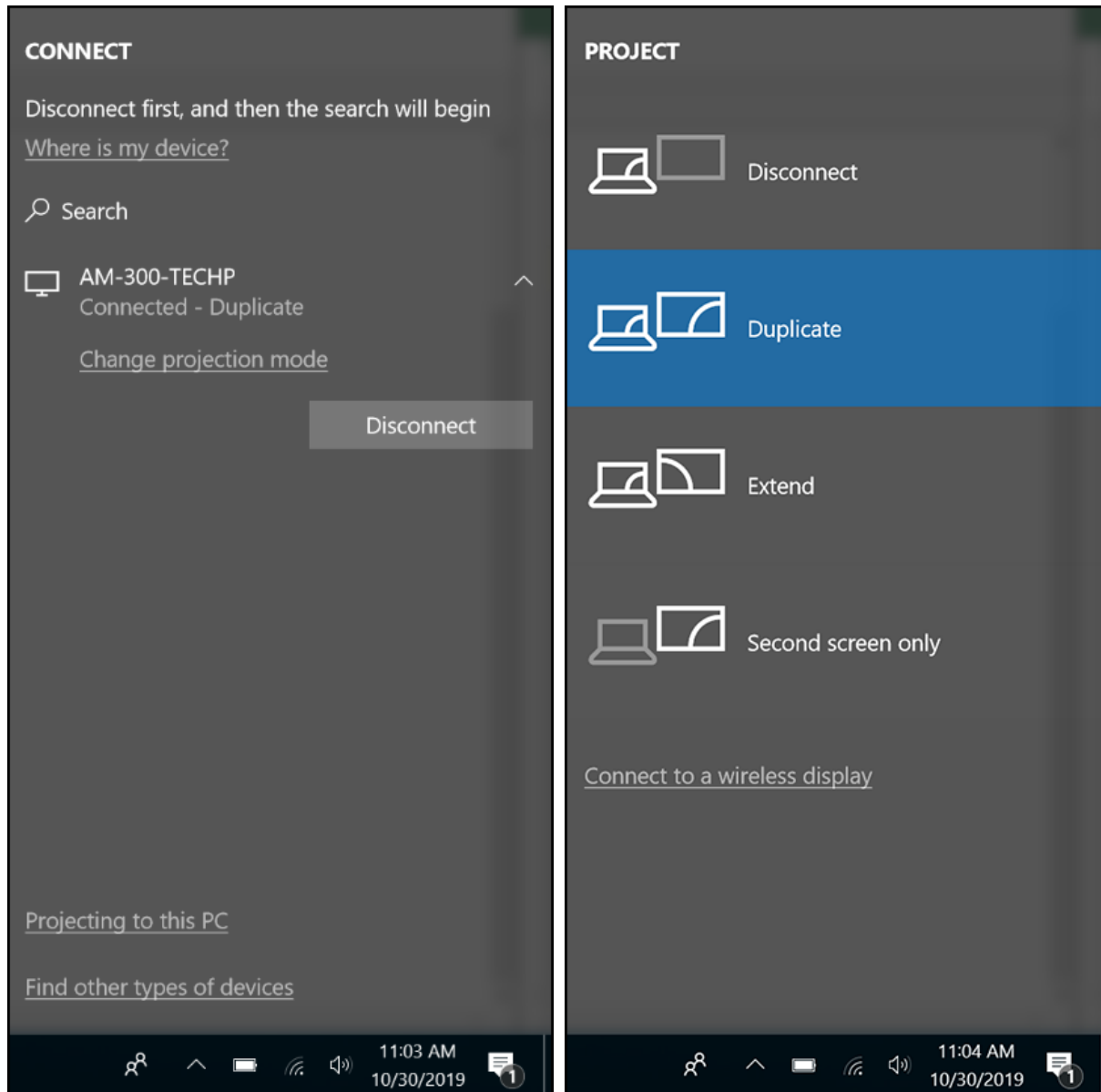

User Experience with macOS

The macOS guest AirMedia sender application is a small file that is downloaded from the AirMedia device, and runs with standard user permissions. The user needs to open the .zip package and then run

the guest AirMedia sender application within the package. The IP address of the AirMedia device is encoded in the file name of the AirMedia sender application so the AirMedia sender application can connect with the AirMedia device upon startup. The user can save the .zip package locally, which enables direct connection to the device the next time the user accesses the AirMedia sender application and AirMedia device.

AirMedia Guest Application on macOS

To use AirMedia presentation on a macOS computer, download the guest AirMedia sender application from the receiver and run the application on a computer.

On an AirMedia Series 3 or AirMedia 2.0 Device

To download the guest AirMedia sender application from an AirMedia Series 3 or AirMedia 2.0 device:

1. Open a web browser and enter the AirMedia device's IP address or host name into the browser. The web browser welcome screen is displayed.

Web Browser Welcome Screen

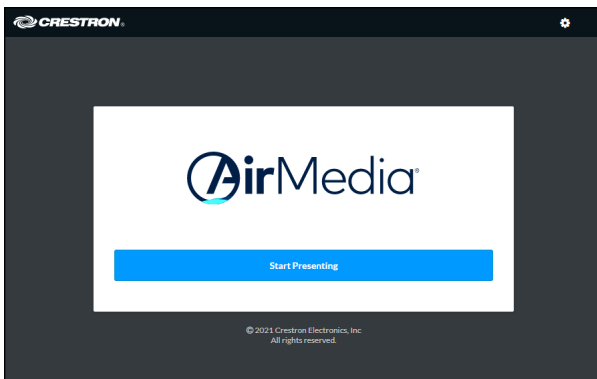

2. Select **Start Presenting**. The AirMedia download screen is displayed.

AirMedia Download Screen

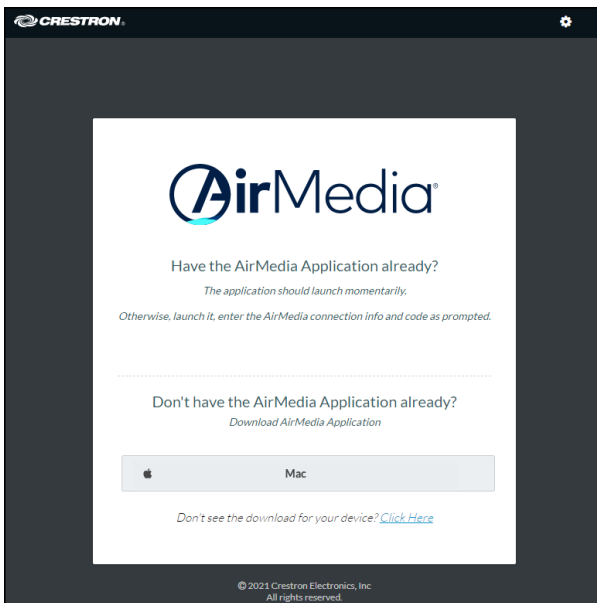

3. Select the **Mac** button to download the AirMedia software for macOS.

On an AM-100 or AM-101

To download the guest AirMedia sender application from an AM-100 or AM-101:

1. Open a web browser and enter the AirMedia device's IP address or host name into the browser.
2. Select the **Download** button next to **Client for Mac®**.

AirMedia Download Screen for AM-100 and AM-101

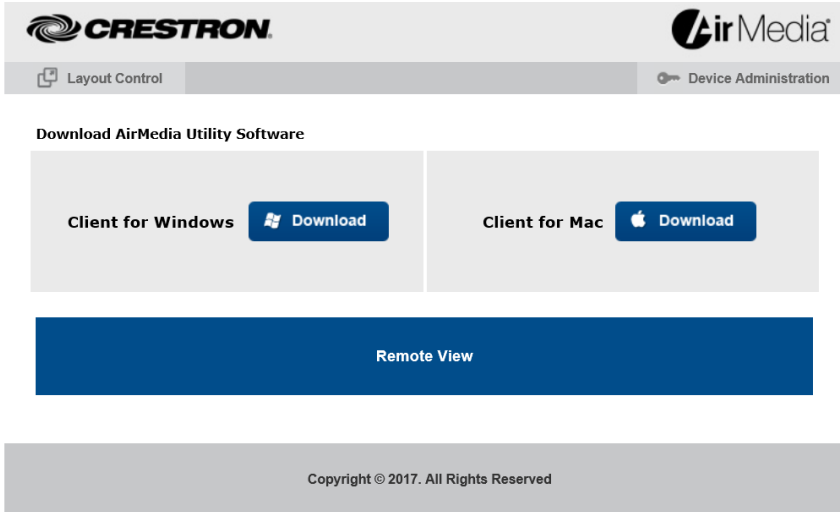

Use the Guest AirMedia Sender Application

To use the AirMedia sender application on a macOS computer:

1. Launch the guest AirMedia sender application. The **Connect** dialog box is displayed.

Connect Dialog Box

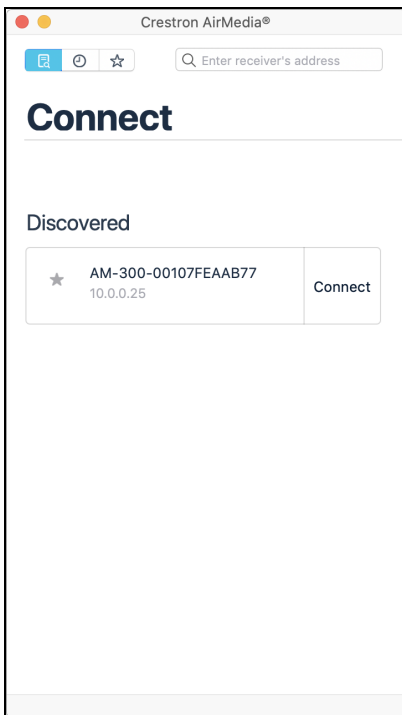

2. Choose the device to connect to, and then select **Connect**.

3. If prompted, enter the login code as shown on the connected display.

- If connecting to an AM-100 that is connected to a configured Crestron Connected display, the display will turn on automatically, and the presentation session begins.
- On all other AirMedia Series 3, AirMedia 2.0, and AM-101 (in mirroring mode) devices, a dialog box is displayed, showing instructions on using the native mirroring function. Follow the instructions to begin the presentation session. Select **OK** when finished to navigate to the presentation controls. If a Crestron Connected display is connected and configured for operation, the display turns on automatically during the process.

Start Screen Mirroring Dialog Box

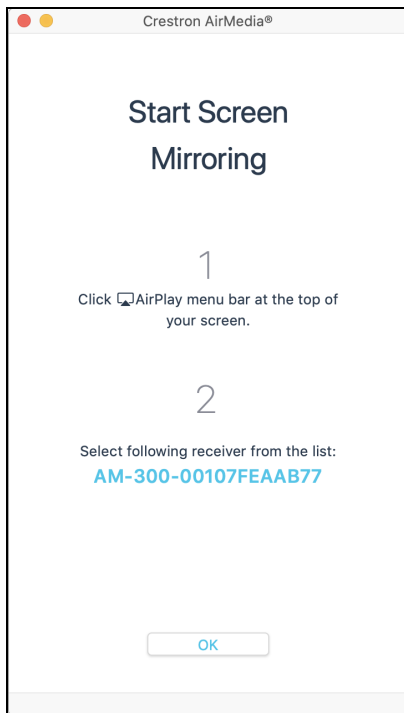

NOTES:

- Only one macOS or iOS device using the native mirroring function can be connected at a time to an AirMedia device. If any other sender connects to the AirMedia device, the last connected device will be disconnected and the connection procedure will need to be repeated.
- The guest AirMedia sender application for macOS can also be downloaded from present.crestron.com and distributed to websites or other media for users to download. The guest AirMedia sender application can be distributed with the connection parameters embedded in the file name so the user only has to enter the login code (if required).

The supported formats are:

`<any_text>_<ip_address>.dmg`

`<any_text>_<ip_address>.dmg`

The underscore and dot must precede the IP address, for example: `executive_conference_room_.10.1.1.13.dmg`.

AirMedia Deployable Application

The deployable AirMedia sender application shows a list of devices in the **Connect** dialog box. The user can select a device for connection or search for a device within a longer list of devices.

To connect to a device, perform the following procedure.

1. Launch the AirMedia sender application. The **Connect** dialog box is displayed.

Connect Dialog Box

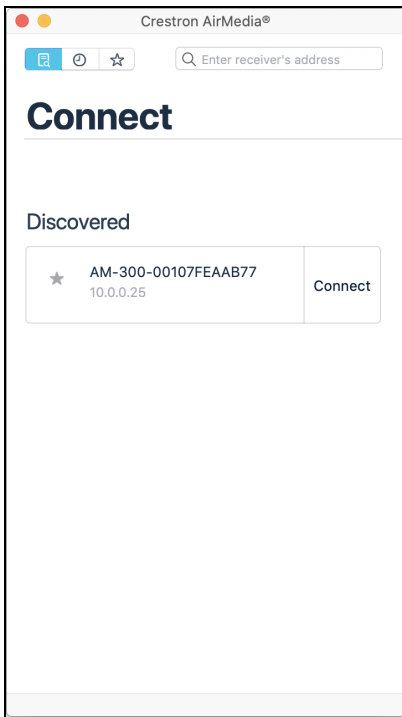

2. Choose the device to connect to, and then select **Connect**.

3. If prompted, enter the code as shown on the connected display.

- If connecting to an AM-100 that is connected to a configured Crestron Connected display, the display will turn on automatically, and the presentation session begins.

NOTE: When using the moderator functions of an AM-100 or AM-101, the user name that appears to the moderator can be set in the Preferences menu. The default username is the same username as the active user logged into macOS.

- On all other AirMedia Series 3, AirMedia 2.0, and AM-101 (in mirroring mode) devices, a dialog box is displayed, showing instructions on using the native mirroring function. Follow the instructions to begin the presentation session. Select **OK** when finished to navigate to the presentation controls. If a Crestron Connected display is connected and configured for operation, the display turns on automatically during the process.

Start Screen Mirroring Dialog Box

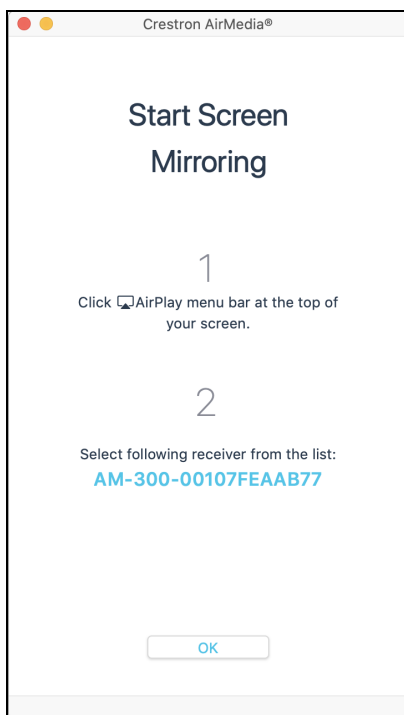

User Experience with Chrome OS

Crestron offers an AirMedia extension for the Google Chrome web browser specifically for mirroring from Chrome OS devices. This is supported with AirMedia Series 3 receivers and the AM-200, AM-300, CCS-UC-1, and CCS-UC-1-X.

NOTE:

- The AirMedia Extension for Google Chrome relies on web technologies for screen sharing that are built in to the web browser. Performance variations with motion video (quality and frame rate) may occur based upon the encoding capabilities of the Chrome OS device and the nature of the content being displayed (i.e., high motion video).

Install the AirMedia extension for Google Chrome

To install the AirMedia extension:

1. Visit the [AirMedia Sender page](#) on the chrome web store.

Chrome Web Store

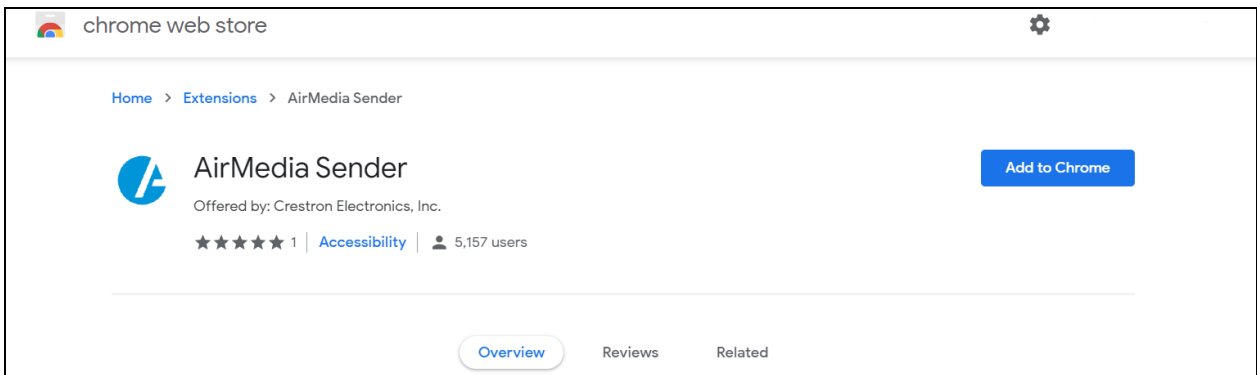

2. Select **Add to Chrome**.

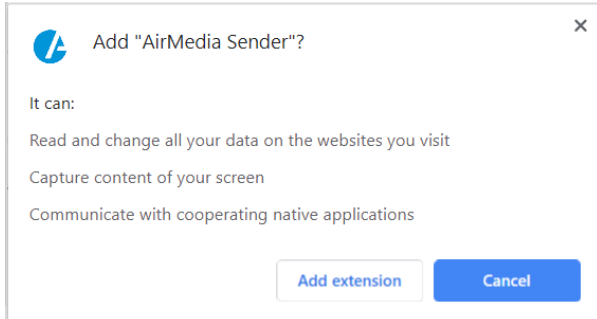

3. Select **Add extension**.

Connect

To connect to an AirMedia receiver using the Chrome extension:

1. Select the AirMedia icon  in the top right corner of the Chrome browser.
2. Enter the IP Address or host name of the AirMedia receiver in the **Connect to AirMedia** field.
3. Select the radio button next to **Present current tab** in the web browser to present only the current web browser tab (with audio) or select the radio button next to **Present desktop** to present the whole screen (without audio).
4. Select **CONNECT**.

Miracast

Miracast is a mirroring protocol and wireless technology used to project your screen to the AirMedia receiver without the need to install an AirMedia sender application on your computer. Miracast is supported on AirMedia Series 3 Wi-Fi compatible (-WF/-WF-I) and AirMedia 2.0 (CCS-UC-1, CCS-UC-1-X, AM-200, and AM-300) products.

Required Wireless Adapter (AirMedia 2.0)

Miracast on AirMedia 2.0 requires the addition of a Wi-Fi network USB Adapter (sold separately). There are two iterations of this adapter available:

- [AM-USB-WF](#) (Sold in the United States)
- [AM-USB-WF-I](#) (Sold Internationally)

Both versions of the adapter support 802.11A/B/G/N/AC wireless networking standards on both the 2.4 GHz and 5 GHz frequencies.

The difference between the US and International Model is the supported Wi-Fi channels.

- **US**
2G Channels: 1, 2, 3, 4, 5, 6, 7, 8, 9, 10, 11
5G Channels: 36, 40, 44, 48, 149, 153, 157, 161, 165
- **World**
2G Channels: 1, 2, 3, 4, 5, 6, 7, 8, 9, 10, 11, 12, 13
5G channels: 36, 40, 44, 48, 149, 153, 157, 161, 165

Miracast Behavior – How it Works

Users connect to a Miracast receiver using the Windows connect menu. The Windows connect menu can be accessed via the Windows notification center or using the shortcut  (Windows) + **K**. On touch-capable Windows 10 devices, swipe in from the right edge of the screen.

Miracast connection has two phases: the discovery phase and the connection phase. The discovery phase uses Wi-Fi based discovery. For this reason, the AirMedia Wi-Fi USB adapter is required for Miracast functionality.

After the list of Miracast receivers is discovered, the user will select a device from the list. Windows 10 will first connect to the Miracast receiver via the existing infrastructure. This is done by resolving the host name through mDNS, then connecting to the receiver over the infrastructure. If the host name cannot be resolved or the connection over infrastructure fails, Windows 10 will establish the Miracast session using the standard Wi-Fi Direct® connection. Wi-Fi Direct is a peer-to-peer connection that establishes a private network between the user device and the receiver. The private peer-to-peer network coexists with the user's other network connections. Once the network is established, Windows

10 will then establish connections over the peer-to-peer network. This two-fold connection mechanism is useful for guest users who may not be connected to the same network.

NOTE: When a Miracast session is connected via Wi-Fi Direct, the connection may automatically terminate after a period of time (typically 60 minutes) due to restrictions placed on a Wi-Fi Direct type connection.

Supported Miracast Devices



Crestron supports using Miracast from Windows 10 (version 1809 or later) and Windows 11. Miracast from Android devices is supported as a preview feature. A Miracast connection over Wi-Fi Direct may produce mixed results. Other limitations may exist.

Considerations for Deploying and Commissioning Miracast

- For optimal performance, the network switch that the AirMedia receiver connects to must have a sufficient buffer size (>2.5 Mb per AirMedia device attached to that switch). In most cases, switches and routers are configured for best-effort packet forwarding. This means that the router forwards all packets it receives to the best of its ability. Everything functions with best-effort forwarding until an interface is oversubscribed. Once an interface is oversubscribed, the router must queue packets to avoid dropping them. The amount of queuing available on an interface determines the amount of momentary oversubscription that the router can tolerate without dropping packets and causing performance degradation.
- Miracast Wi-Fi Direct requires a PIN code to be set. For this reason, AirMedia devices will not allow you to disable the login PIN code if Wi-Fi Direct is enabled.
- When commissioning the device and configuring the login code mode, the device may not initially recognize a change. Within a few minutes, the change will be reflected.
- Crestron recommends that the host name of the device should be 22 characters or less to ensure proper discovery by a Windows device and to ensure readability on the front-of-room experience screen.
- (AirMedia 2.0 only) Crestron recommends connecting a USB extension cable to the Wi-Fi adapter (not supplied). Place the adapter in an optimal location to minimize interference from the connected device's chassis.

Troubleshooting Miracast Connection Issues

- (AirMedia 2.0 only) Ensure the Wi-Fi adapter is enabled on the client device and that the latest drivers are installed for that adapter.

- Ensure the network is not blocking any of the Miracast related ports (7236, 7250) listed in the [Firewall Settings & Port Table on page 25](#).
- Ensure the network is not blocking the mDNS discovery port (5353) listed in the [Firewall Settings & Port Table on page 25](#).
- Check for Miracast support on the client device:
 1. Press  (Windows) + **R** and type **dxdiag**.
 2. Select **Save All information....**
 3. Open the saved DxDiag.txt and find Miracast. It should say **Available, with HDCP**.
- Check the firewall on the client device.
 Disable the firewall and test projection. If Miracast works with the firewall disabled, add an exception for
 C:\Windows\System32\WUDFHost.exe
 Allow In/Out connections for TCP and UDP, Ports: All.
- Check the group policy settings on the client device. On domain-joined devices, Group Policy can also block Miracast.
 1. Press  (Windows) + **R** and type **rsop.msc** to execute the Resultant Set of Policy snap-in. This will show the current policies applied to the computer.
 2. Review **Computer Configuration > Windows Settings > Security Settings > Wireless Network (IEEE 802.11) Policies**.
 3. Double-click the setting for wireless policies and a dialog box will appear.
 4. Open the **Network Permissions** tab and select **Allow everyone to create all user profiles**.

Wireless Conferencing

Wireless Conferencing enables video calling for almost any meeting room application.

Requirements

When using the Wireless Conferencing feature, be aware of the following:

- Wireless Conferencing is only supported on AirMedia Series 3 devices.
- A computer that meets or exceeds the following is required:
 - Windows 10 version 1809 or Windows 11 version 21H2
 - AirMedia application version 5.5.1.84
 - Intel® Core™ i5 6th generation processor (or AMD equivalent)
 - 8GB RAM

NOTES:

- ARM-based processors are not supported.
- Set the computer to **Best Performance** mode to avoid resolution or latency issues.

- Wireless Conferencing drivers must be installed on the computer.
 - Links to these drivers can be found on the AirMedia device product page and in the firmware release notes.
 - Driver installation requires admin rights.
- Wireless Conferencing must be enabled in the web configuration as described in the [AirMedia Series 3 Receivers Product Manual](#).
- PoE+ or a local power supply is required. Do not simultaneously provide PoE and local power.
- Wireless Conferencing requires a PIN code to be set. For this reason, AirMedia devices will not allow you to disable the login PIN code if Wireless Conferencing is enabled.
- When multiple users are presenting, user names must be unique. This can be set in the AirMedia application under **Options**.

Peripherals

For best results when using Wireless Conferencing, consider the following:

- A list of officially supported peripherals can be found on [OLH 1001764](#).
 - Unlisted peripherals may still function.
 - More peripherals will be supported over time.

- Do not connect two cameras at the same time. When selecting peripherals, use one of the following options:
 - An all-in-one peripheral with both speakerphone and camera functions.
 - A single-purpose speakerphone and a single-purpose camera.
- USB hubs and USB extenders are not supported.

NOTES:

- If a soundbar is connected to the AirMedia device, audio will be routed to it regardless of Wireless Conferencing settings.
- Volume control may not be available for all USB speaker peripherals.

AirMedia Connect Adaptor

Wireless Conferencing on the AM-TX3-100 uses a point-to-point wireless link to transmit a user's laptop to a front-of-room display while simultaneously allowing a user to wirelessly leverage in-room conferencing peripherals on their laptop for a video conference of their choice. The solution strives to minimize latency for the optimal user experience. When using the Wireless Conferencing feature with the AM-TX3-100, consider the following:

- The supported peripheral list on [OLH 100176](#) indicates devices verified for use with the AM-TX3-100.
- Refer to the [Wireless Best Practices](#) section of the [AirMedia Series 3 Product Manual](#).
- If experiencing high latency, adjust the [Quality Mode](#).

Supported Meeting Applications

The following meeting applications are supported with Wireless Conferencing:

- Microsoft Teams® software
- Zoom™ software

User Experience

With Wireless Conferencing enabled, **Conferencing** ⓘ appears in the Windows desktop application presentation screen.

Presentation Screen

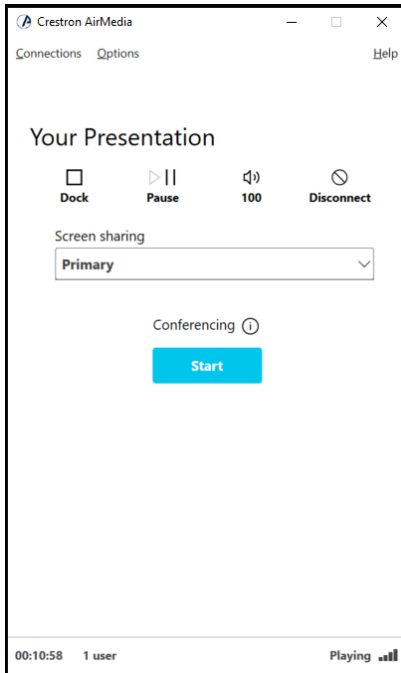

Clicking the ⓘ will bring up the peripheral information screen. This screen indicates the types of peripherals connected.

Peripheral Information Screen

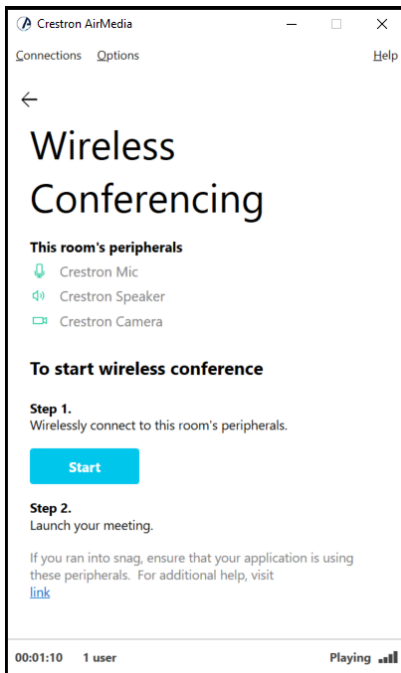

Pressing the blue **Start** button on the presentation screen or peripheral information screen will connect the computer to those peripherals. This will allow their use in most meeting room applications. On the room display, icons for each connected device type (camera and/or microphone) will appear.

Selecting Peripherals

When using Wireless Conferencing, the peripherals connected to the AirMedia device must be selected within the meeting application. Depending on the meeting application, that process may be slightly different.

- See the meeting application's documentation for instructions on selecting peripherals.
- As a general rule, a connected peripheral will be designated as a **(Crestron Airmedia Virtual Device)**.
- With any meeting application, **Speakers (Crestron Airmedia Virtual Speaker)** must be selected as the audio playback device within Windows. To do this, perform the following steps:
 1. Click  in the Windows task bar.
 2. Click **Select playback device**.
 3. Select **Speakers (Crestron Airmedia Virtual Speaker)**

Select Playback Device Screen

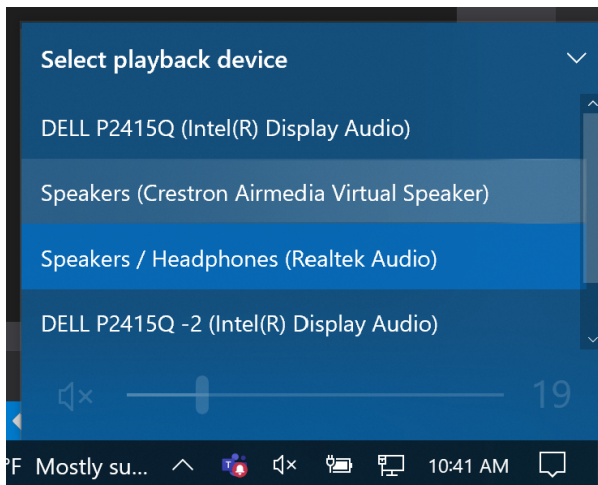

AirMedia Canvas

The AirMedia Canvas feature enables the viewing of multiple sources on the display. With an AM-200 or AM-300, two sources can present simultaneously. With an AirMedia Series 3 receiver, up to four sources can present. The sources can be:

- AirMedia (Windows/Android/Mac/iOS, or Miracast).

NOTE: The AirMedia Extension for Chrome OS is not supported in the dual view configuration on AM-200 and AM-300 devices and will only be allowed to present full screen.

- HDMI
- DigitalMedia (on AM-200 and AM-300 devices)
- Whiteboard (on AM-200 and AM-300 devices)

The source mode or the types of sources allowed in the AirMedia Canvas can be configured.

- **All Sources:** When selected, all sources are available to the AirMedia Canvas in the dual view configuration.
- **Network Sources Only:** When selected, only AirMedia, Miracast, or Whiteboard (AM-200 and AM-300 devices only) sources are available to the AirMedia Canvas in the dual view configuration. HDMI and DigitalMedia (AM-200 and AM-300 devices only) in this mode would always present full screen if selected.

AirMedia Canvas examines the resolution, aspect ratio, and orientation of each source and then lays out the sources to maximize screen real estate. A persistent overlay provides connection information, user count, and time when one or two users are presenting. This overlay can be disabled in the configuration of the product. Up to 10 AirMedia users can be connected simultaneously.

NOTES:

- When AirMedia Canvas is on, the 4:2:0 color space is used for high definition sources connected to the HDMI input port. When AirMedia Canvas is off, the 4:4:4 color space is used. If the 4:4:4 color space is required by sources connected to the HDMI input port, AirMedia Canvas should be turned off.
- AirMedia Canvas can be turned on or off via control system joins. However, there are no joins for controlling the layout or position of the sources.
- The persistent overlay can be enabled even if AirMedia Canvas is off.

AirMedia Canvas can be controlled with a paired touch panel using the .AV Framework 2.0 Interface, a computer running the AirMedia client, or an iOS device running the AirMedia app. This allows a participant to manage how many sources are shown on the screen. When two sources are shown on the screen, a swap button is provided for all presentation types to quickly move the user's presentation from the left to the right side of the display or vice versa. When more than two sources are shown on an

AirMedia Series 3 receiver, the swap button is unavailable. For wireless presentations only, participants can also control features such as pause and resume, mute, and disconnect.

AirMedia Canvas controls can be set independently of AirMedia Canvas. In scenarios where Canvas controls are on and AirMedia Canvas is off, users can still control all connected participants' presentations as previously described, but only one participant can present at a time.

NOTES:

- The .AV Framework 1.0 Interface does not support AirMedia Canvas controls.
- When a participant resumes a wireless presentation from a paired touch panel, the sender application receives a resume request. The request must be approved before the presentation resumes. Settings are available in the sender applications to automatically approve or deny presentation requests.
- Apple® devices do not currently support pause and resume controls on the AirMedia Canvas. This functionality will be added in the future.
- A timeout feature is available on AirMedia Series 3 and AM-200/300 receivers to automatically disconnect docked users if they forget to disconnect when leaving a room. Refer to either the [AirMedia Series 3 Receivers Product Manual](#) (Doc. 9020) or the [AM-200 and AM-300 Product Manual](#) (Doc. 8254) to configure the timeout setting.
- When using Wireless Conferencing in conjunction with AirMedia Canvas controls, a green icon appears in the Session control interface for each type of connected peripheral. These icons do not offer control.

Windows AirMedia Client Canvas Controls

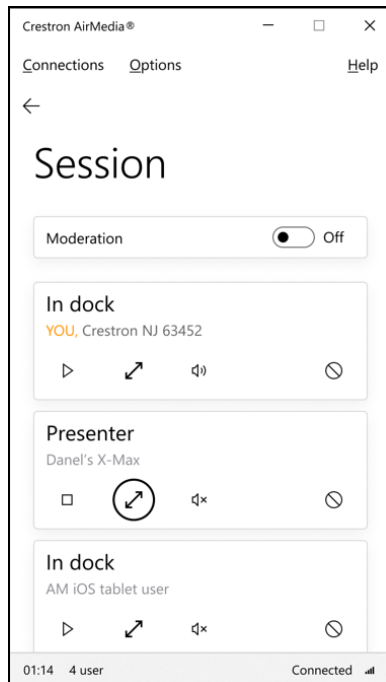

.AV Framework 2.0 Touch Panel Canvas Controls

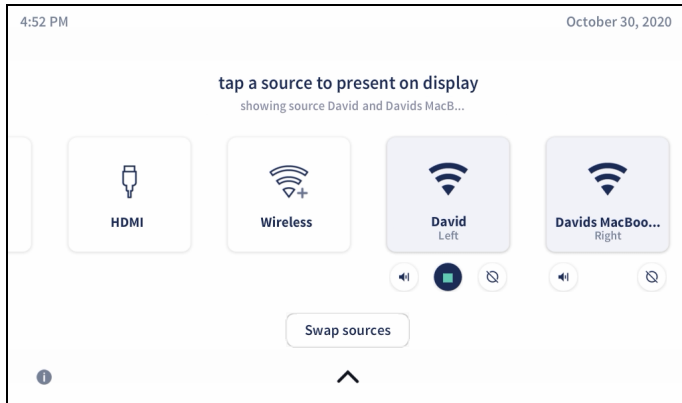

Windows AirMedia Client Canvas Controls With Wireless Conferencing

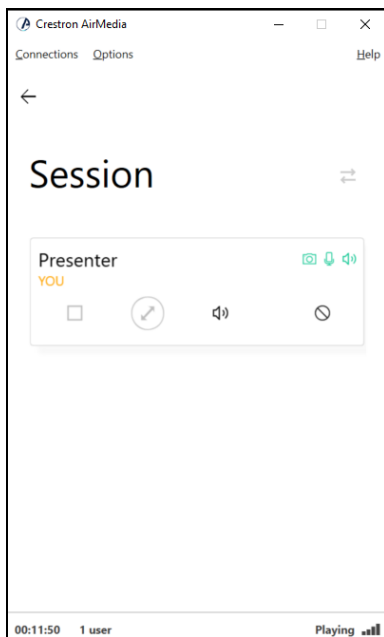

AirMedia Apps

The AirMedia apps for iOS and Android are the primary way for mobile and tablet devices to connect to AirMedia receivers.

AirMedia App for iOS Devices

This app is designed for iPhone® and iPad® devices. To download the app, refer to the [Crestron AirMedia app page](#) in the App Store.

This app is only available for download from the App Store for iOS devices. The download may also be accessed through the AirMedia landing page by typing the AirMedia enabled device's IP address into a web browser. If connection to an AM-100 is attempted from this app, the AirMedia for AM-100 app will be launched or, if not installed, the user will be directed to the app store to install this app.

AirMedia for AM-100 App for iOS Devices

This app is designed for iPhone® and iPad® devices connecting to AM-100 AirMedia Presentation Gateways, as well as the AM-101 when using moderator mode or quad view. To download the app, refer to the [Crestron AirMedia for AM-100](#) app page in the App Store.

This app is only available for download from the App Store for iOS devices and does not provide full-screen mirroring. Documents are rendered within the app, and control for other functions relating to moderation are also contained within the app.

AirMedia App for Android Devices

This app is designed for Android devices. To download the app, refer to the [Crestron AirMedia app page](#) in the Google Play™ store.

The download may also be accessed through the AirMedia landing page by typing the AirMedia enabled device's IP address into a web browser.

AirMedia for AM-100 App for Android Devices

This app is designed for Android devices connecting to AM-100 AirMedia Presentation Gateways, as well as the AM-101 when using moderator related functions. To download the app, refer to the [AM-100 product page](#).

This app does not provide full-screen mirroring. Documents are rendered within the app, and control for other functions relating to moderation are also contained within the app. If connection to an AirMedia Series 3 or AirMedia 2.0 receiver is attempted using this app, the app will fail to connect.

Connect to AirMedia Devices with Mobile Applications

AirMedia sender applications connect to AirMedia devices by discovering them or by navigating to a manually entered device IP address or host name.

Connected devices are saved to allow for easier future connection. A search function provides quick navigation of long lists. Frequently used AirMedia devices can be marked as favorites for quick connections.

AirMedia app connection screens are shown below.

AirMedia for iOS

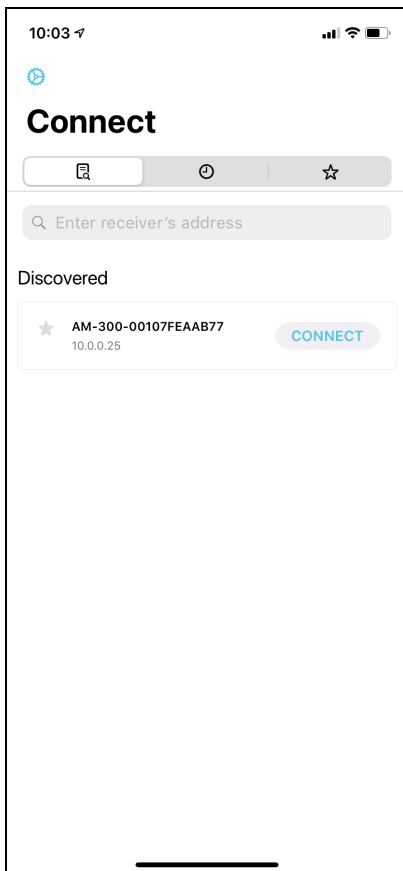

AirMedia for Android

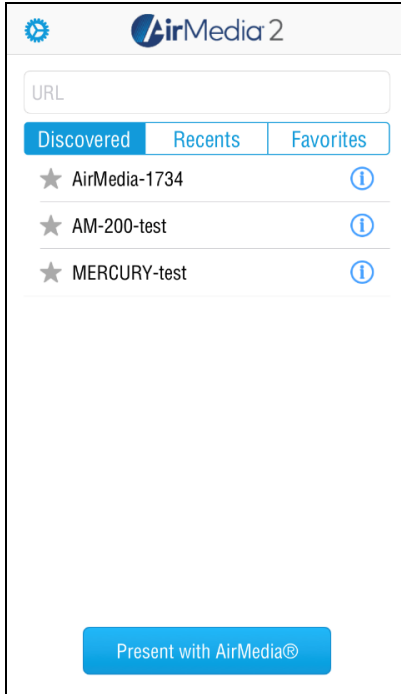

AirMedia for AM-100 on iOS and Android

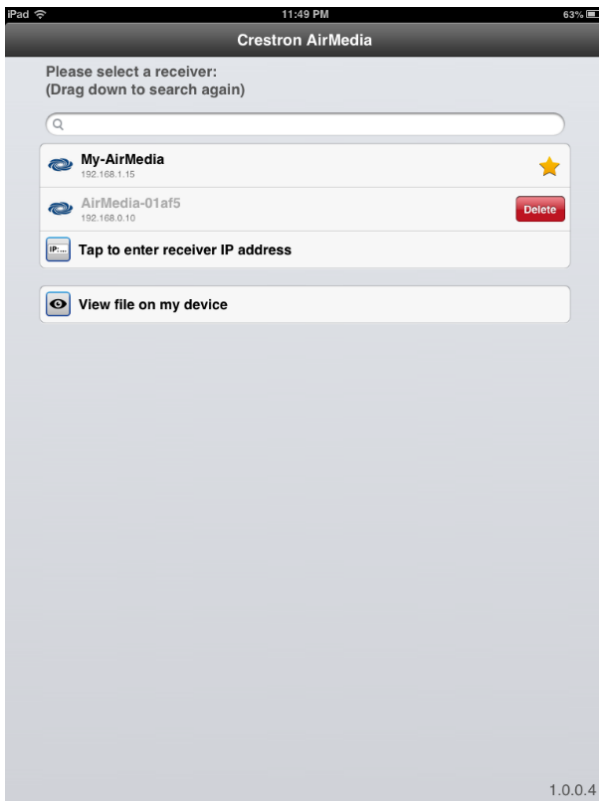

Since the iOS AirMedia sender application uses the built-in iOS device screen mirroring feature, the AirMedia sender application will not present immediately after connecting to the AirMedia receiver. For

detailed instructions on connecting to an AirMedia device from iOS, refer to either the [AirMedia Series 3 Receivers Product Manual](#) (Doc. 9020) or the [AM-200/AM-300 Product Manual](#) (Doc. 8254).

Connect with iOS App

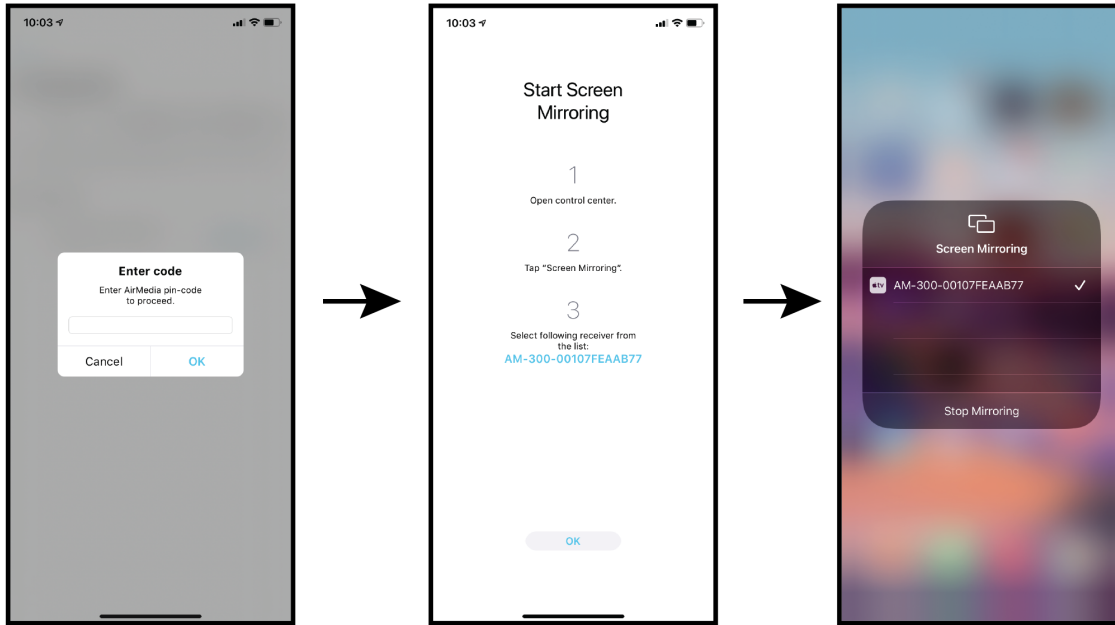

Video Push

iOS apps for video streaming employ an alternate mode for playing videos on AirMedia Series 3 and AirMedia 2.0 devices called Video Push. When using these apps, video plays directly on the AirMedia receiver rather than on the device. The app may provide controls in the area of the app where the video would normally be played. This mode assists the iOS device in saving battery life as well as utilizing the wired portion of the network to further enhance playback reliability.

App Controls for Streaming Content



NOTES:

- Video streaming from third party apps may not work correctly on the AM-101.
- Video streaming apps may occasionally change the way they interact with iOS device mirroring that interferes with the correct operation of playback mode. When such compatibility breaks, the video streaming app must be updated to restore correct functionality.
- Video Push requires the sender and receiver to be on the same subnet.

Test and Commission the AirMedia Presentation System

Once AirMedia devices are selected and deployed in a properly provisioned network, and AirMedia sender applications and mobile apps are configured, the AirMedia device for each room should be tested prior to commissioning the device.

AirMedia Test Use Cases by User Experience

When testing AirMedia, use cases are typically split in priority as follows:

- Desktop users
- Mobile users

Testing the entire flow of the desktop and mobile AirMedia experiences helps ensure that mass deployment is successful.

Front of Room Experience

All AirMedia use cases center around the user's ability to access the AirMedia device through the front-of-room experience screen. On the front-of-room experience screen, each AirMedia device can display connection information and customizable backgrounds.

In simpler rooms such as huddle spaces, the default front-of-room experience should be used in every case. Simpler rooms are where the only devices for presentation are AirMedia Series 3, AM-200, AM-300, CCS-UC-1, or CCS-UC-1-X devices, along with any attached sensors, switches, and panels. For more complex configurations where simpler AirMedia devices are attached (i.e., DMPS3-4K-250-C, DMPS3-4K-350-C, and other Crestron products that have multiple inputs and/or use programming via control processors), the system should be programmed and controlled to use the default front-of-room experience.

There are some cases that do not allow for the default front-of-room experience. In these cases, clear instructions for accessing the AirMedia welcome screen or the AirMedia connection information (such as address and code for room) should be provided to users. Whenever controls such as buttons or panels are present, they should be clearly labeled and highly visible so users can access AirMedia.

The customizable background feature is an effective way to give guidance to all AirMedia users in any room and should be leveraged whenever possible. On AirMedia Series 3 and AirMedia 2.0 devices, there are additional options for the connection address, including a custom option that allows for entry of something other than the IP address or host name of the device. This can also be set to text instructions, URL shortening services, or anything else an administrator may need to assist the user connection experience.

PC User Experience Test Case Considerations

PC users typically comprise 85-90% of the total types of users, with mobile users taking up the remainder. The user experience will vary in environments with mixed Windows and macOS computers. Instructions for AirMedia sender application use vary as discussed in [AirMedia Sender Applications for User Download on page 51](#). To provide an optimal AirMedia user experience:

- Install the AirMedia deployable AirMedia sender application silently with the appropriate options for operation. Application management from a central organization can also provide a uniform user experience.
- Provide basic guidance to users through the front of room experience. Instructive, on-screen backgrounds or instruction placards can also be provided to advise users on proper use.
- Provide optimal methods for room discovery, such as centralized room lists and allowing mDNS and Bonjour (including third party solutions).
- Design user interfaces (i.e., panels or buttons) for clarity to enable ease of use when first connecting to AirMedia.

Test all of the intended connection methods prior to commissioning a system to ensure a smooth user experience.

Mobile User Experience Test Case Considerations

Mobile users comprise up to 15% of total types of users. While the same considerations for PC users can apply to mobile users, specific considerations for mobile users include:

- Installation of the AirMedia app typically requires users to access the respective app store for the device. Installation cannot be automated, so guidance will need to be given.
- The AirMedia app allows users full-screen capture for AirMedia Series 3, AirMedia 2.0, and AM-101 devices.
- The AirMedia for AM-100 app is primarily for AM-100 (or AM-101) users or those who require multiview and moderator mode functions. The AirMedia for AM-100 app will launch automatically from the AirMedia app (if installed) when an attempt is made to connect to the AM-100. If the correct app is not installed, the user will be directed to the corresponding app store to download the correct AirMedia sender application.
- While the iOS and Android AirMedia sender applications have similar user interfaces, the iOS experience requires use of iOS' built in mirroring function. Instructions for use are given to the user upon connecting to the AirMedia receiver.
- Room lists are not available on AirMedia mobile apps. The AirMedia and PinPoint™ apps, however, do have the capability to use Bluetooth beacons such as the Crestron PP 100 provisioned through Crestron Fusion to automatically present room connection information. Refer to the Crestron Fusion and Crestron PP 100 product documentation for details on configuring Bluetooth room beacons.

NOTE: AirMedia Series 3 receivers are not compatible with the PinPoint app.

- Although streaming apps for popular video services are supported in AirMedia, the AirMedia device must be on the same subnet as the mobile device to function correctly. These apps may occasionally exhibit erratic behavior on mobile devices when the app is updated. It is recommended to contact the app vendor in the event such behavior persists.

Testing for mobile users should encompass the considerations above for both the AirMedia app and the AirMedia for AM-100 app.

Commission and Monitor AirMedia Devices

Once the use cases for AirMedia are established and tested, and other room functionality is tested, the commissioned room is ready for AirMedia and other uses. For optimal performance, AirMedia use cases should be reevaluated as time and circumstances permit. Crestron provides cloud tools such as Crestron Fusion and the XiO Cloud service to understand how AirMedia-enabled rooms are used. Analyzing usage information and patterns can help adjust rooms to user needs for AirMedia, while monitoring tools can minimize downtime and user complaints should an issue arise. These monitoring tools should be used in conjunction with network monitoring wherever possible to determine issues with Wi-Fi access points and the general health of the network.

This page is intentionally left blank.

