



Description

The Crestron® Zūm™ occupancy and vacancy sensors detect when a person enters and exits a space. They communicate wirelessly with Zūm™ wireless devices to turn the lights on and off based on room occupancy and vacancy.

Featuring passive infrared (PIR) technology, the ZUMMESH-PIR-OCCUPANCY-BATT (occupancy sensor) and ZUMMESH-PIR-OCCUPANCY-BATT (vacancy sensor) reliably detect when a person enters and exits the space.

Install up to 8 occupancy or vacancy sensors to ensure coverage in a large room.

NOTE: Do not mix occupancy and vacancy sensors in the same room.

NOTE: When using the ZUMMESH-AVBRIDGE with an AM-200 or AM-300:

- To install, refer to the "Installation," "Calibration and Testing," and "Mounting and Masking Locations" sections that follow.
- To configure, refer to the AM-200/AM-300 Product Manual (Doc. 8254) at www.crestron.com/manuals for wireless connections, setup, and operation.

Zūm Overview

A Zūm space consists of one space, such as a board room or conference room, that is equipped with Zūm mesh devices. The Zūm mesh devices (i.e., dimmers, switches, keypads, and sensors) in the space provide control and communicate directly with each other without the need for a centralized gateway or processor.

To expand the functionality of the Zūm space, a ZUMMESH-NETBRIDGE (not included) can be added which provides centralized control and monitoring from a Crestron control system (not included).

NOTE: The ZUMMESH-NETBRIDGE requires a compatible J-box device (not included) to provide power.

Select the Mounting Location

Use the following diagrams to determine the mounting location for the occupancy or vacancy sensor. Ensure a vibration-free mounting surface.

Sensor Coverage Areas - Side View 8-12 ft (~2.5-3.5 m)

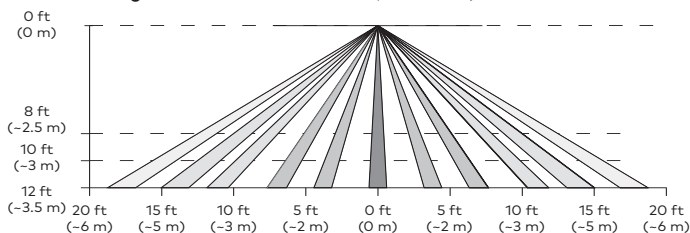

Sensor Coverage Areas - Top View (8 ft (~2.5 m))

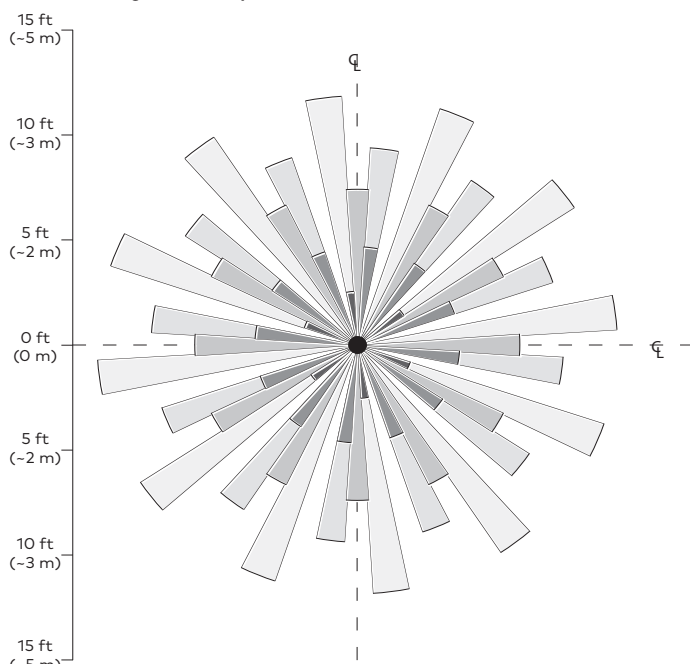

- NOTE:**
- The occupancy and vacancy sensors must have a clear view of the entire room. The device should not be blocked by furniture or fixtures.
 - Avoid false triggering by mounting it away from air vents, fans, windows, and other devices that create air movement in the room.

Install the Sensor

To complete the installation, the occupancy and vacancy sensors ship with (2) Plastic wall anchors, (2) Phillips head screws, and (1) Ultralife 9 volt lithium battery. A Phillips tip screwdriver and a pencil are required for installation (not included).

If desired, the sensor may be painted to match the ceiling color. However, do not paint over the dome as this significantly hinders sensing capabilities.

NOTE: Install and use this product in accordance with appropriate electrical codes and regulations.

Mount the sensor to the ceiling.

1. Mark the location for the two plastic wall anchors. The marks should be 3 in (76 mm) apart.
2. Install the plastic wall anchors.

NOTE: For surfaces other than drywall and drop-ceiling tiles, pre-drill the mounting location for the plastic wall anchors.

3. Twist the sensor cover counterclockwise to separate the cover from the base.

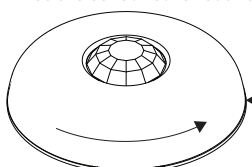

Hold the sensor base in the palm of your hand and twist the cover counterclockwise to separate the base from the sensor cover.

4. Secure the base to the plastic wall anchors using the provided Phillips head screws.

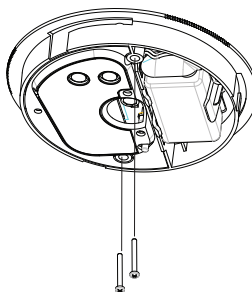

5. Connect the battery to the two terminals in the sensor and secure the battery to the base.

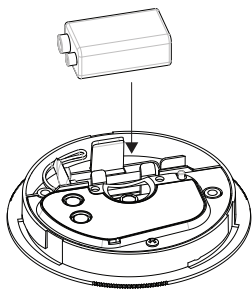

6. Place the cover on the base and then twist the cover clockwise to secure it to the base. The assembly clicks when secured.

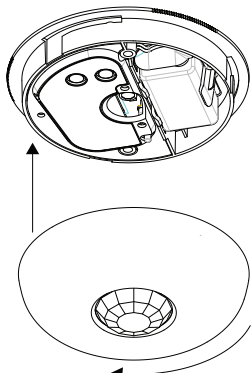

Rotate to secure the cover.

Operate the Occupancy or Vacancy Sensor

Occupancy and vacancy sensors toggle the lights and plug controllers in the room based on the room status.

Up to 8 Occupancy or Vacancy sensors can be installed in the same space. When multiple sensors are installed, the space is considered occupied when any sensor detects motion and the space is considered vacant after all sensors detect vacancy.

NOTE: After an occupancy or vacancy sensor stops detecting motion, a timeout period occurs and then it turns off the lights (recalls scene 16 from the load controller). Refer to the "Timeout Settings" section to set the timeout.

Occupancy Sensor Control

The occupancy sensor controls the lights and the plug controller based on occupancy or vacancy. Refer to the chart below for details.

	Occupied	Vacant
Lights	Turn On (scene 1)	Turn Off
Plug Controller	Turn On	Turn Off

Vacancy Sensor Control

The vacancy sensor controls the lights and the plug controller based on occupancy or vacancy. If the vacancy sensor detects motion within 30 seconds of turning off the lights, the vacancy sensor switches the lights back on.

Refer to the chart below for details.

	Occupied	Vacant
Lights	No Action	Turn Off
Plug Controller	Turn On	Turn Off

NOTE:

- Sensors may not work as expected if occupancy is detected, the lights turn on, and then the user manually turns off the lights from a local switch and decides to re-enter the room before the timeout has completed. In this situation, the lights will not turn on automatically. The sensor is reliant on a full completion of cycles (vacancy, then occupancy, then vacancy) to work correctly.
- Rooms can be programmed to be occupied while the lights are off by utilizing scenes or sensor-disabling buttons.

Calibrate and Test the Sensor

Adjust the settings that are available under the sensor cover and then test the operation.

Timeout Settings

The time that the sensor takes to declare the room vacant after motion is no longer detected is determined by the timeout setting. The timeout knob inside the sensor can be set between 30 seconds and 30 minutes.

If no motion is detected during the timeout period, the lights turn off. If motion is detected during the timeout period, the sensor waits until it no longer detects motion and then begins a new timeout period.

A timeout of 15 minutes would be typical for a conference room application.

Sensitivity Settings

Set the sensitivity of the sensor to high for normal use. If false triggers occur, turn down the sensitivity until false triggers no longer occur.

Test Button

Press the **TEST** button to verify that the sensor is connected to the system. The lights in the space toggle to indicate that the device is connected.

Mask the Sensor

To prevent unwanted motion from triggering the lights, install a mask in the sensor to conceal the lens and to block the view of certain areas in the space. Use the PIR 1/2 mask to block half of the detection range or the perforated PIR 360-degree (12-section, 30-degree per section) mask to provide custom masking.

NOTE: The half mask comes preinstalled. If the perforated mask is to be used, it should be installed in the same manner as the half mask.

Refer to the following illustrations for typical masking applications. The first illustration shows a PIR 360-degree mask, the second shows a PIR 1/2 mask.

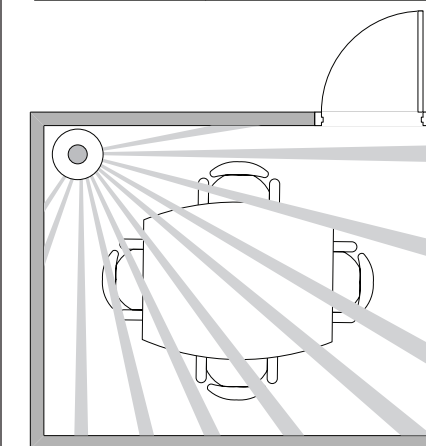
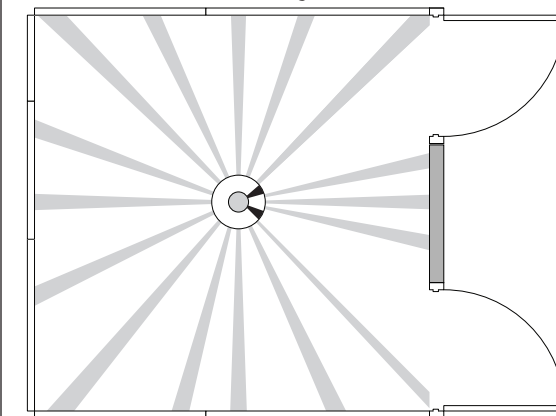

Test Mode

Test mode allows the installation location of the occupancy or vacancy sensor to be verified. Test mode exits automatically after 2 minutes.

To enter Test mode, press and hold the **TEST** button until the LED lights. While in test mode, the green LED flashes slowly.

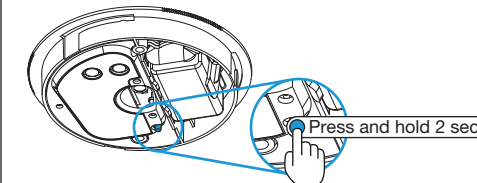

Walk around the room and in front of windows and open doorways to verify operation. The red LED lights when motion is detected.

How to Set Up a Züm Space and Add Züm Devices

Once all devices are physically installed in a board room or conference space, a new Züm space can be created and devices added.

NOTE:

- Only set up one Züm space at a time.
- For simplified setup of a Züm space, use the Züm app on a mobile device.

Step 1 Create a New Züm Space

Creating a Züm space defines the area where the devices are located, such as a board room or conference room. A Züm space is created with a keypad, dimmer or switch, a J-box device, or an AV Bridge.

NOTE:

- Creating a Züm space can only be performed by one device in the space.
- A Züm space cannot be created from a battery-powered keypad.

To create a new Züm space using an AC powered keypad, dimmer, or switch:

1. Press the bottom button 5 times.
2. Press and hold the bottom button until the LED on the device lights. After approximately 3 seconds, the device LED begins slowly flashing. This indicates that the Züm space is now created and in Joining mode, allowing you to add devices.

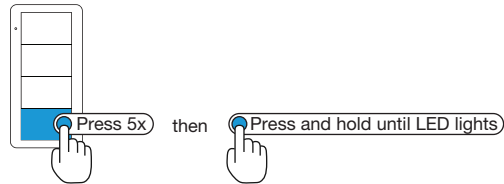

To create a new Züm space using a J-box device or an AV Bridge:

1. Press the **Setup** button 5 times.
2. Press and hold the **Setup** button until the LED on the device lights. After approximately 3 seconds, the device LED begins slowly flashing. This indicates that the Züm space is now created and in Joining mode, allowing you to add devices.

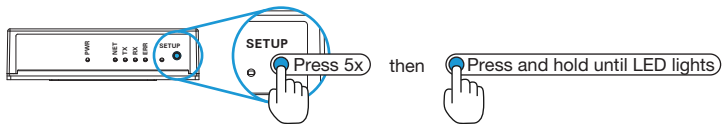
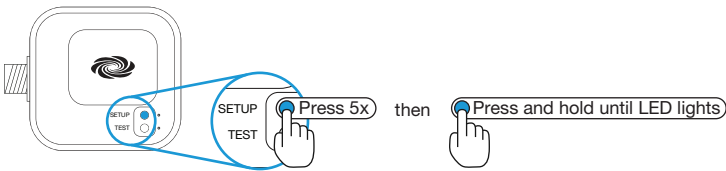

NOTE: The device that is used to create the Züm space is automatically added to the space and does not need to be added in Step 2.

Step 2 Add the Occupancy or Vacancy Sensor to the Züm Space

After a new Züm space is created, add the occupancy or vacancy sensor while the space is in Joining mode.

NOTE:

- A Züm mesh device can belong to only one space.
- Joining mode ends automatically after 4 minutes.

To add the occupancy or vacancy sensor:

1. Press the **TEST** button 3 times.
2. Press and hold the **TEST** button until the LED on the sensor lights to indicate that it has joined the space.

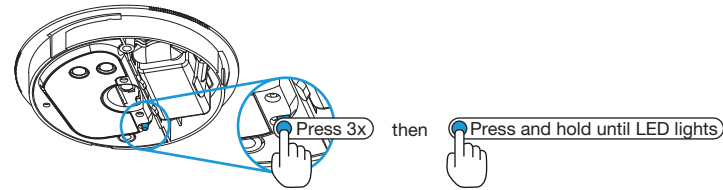

Step 3 Complete Züm Space Setup

To finish creating a Züm space, press any button on an AC-powered device that is part of the Züm space to exit Joining mode.

Add the Occupancy or Vacancy Sensor to an Existing Züm Space

Add new Züm devices to an existing Züm space by placing the Züm space in Joining mode.

Add the Occupancy or Vacancy sensor using an AC powered keypad, dimmer, or switch:

1. Enter Joining mode.
 - a. Press and hold both the top and bottom buttons until the LED lights.
 - b. Press the top button once.
 - c. Press the bottom button once. The LEDs on all devices in the space (except battery powered devices) flash slowly to indicate that the devices are part of the space and that the space is in Joining mode.

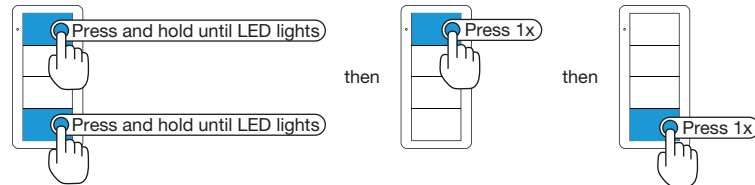

2. Add the occupancy or vacancy sensor.
 - a. Press the **TEST** button 3 times.
 - b. Press and hold the **TEST** button until the LED on the sensor lights to indicate that it has joined the space.

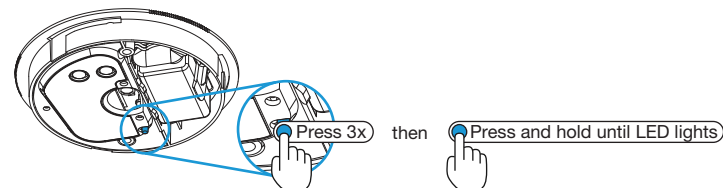

3. Press any button on an AC-powered device that is part of the Züm space to exit Joining mode.

Add the Occupancy or Vacancy sensor using a J-box device:

1. Enter Joining mode.
 - a. Press the **SETUP** button 2 times.
 - b. Press the **TEST** button once. The LEDs on all devices in the space (except battery powered devices) flash slowly to indicate that the devices are part of the space and that the space is in Joining mode.

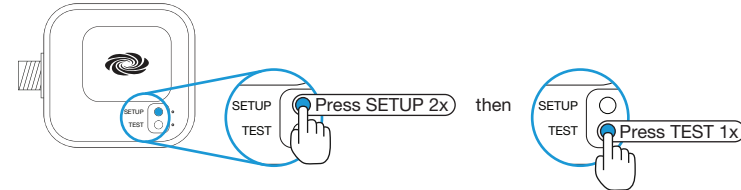

2. Add the occupancy or vacancy sensor.
 - a. Press the **TEST** button 3 times.
 - b. Press and hold the **TEST** button until the LED on the sensor lights to indicate that it has joined the space.

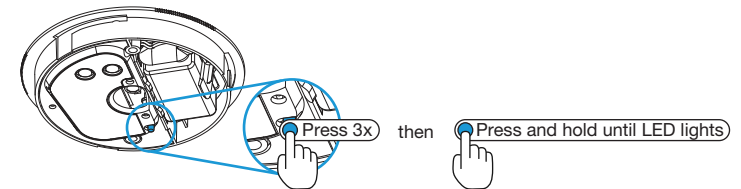

3. Press any button on an AC-powered device that is part of the Züm space to exit Joining mode.

Add the Occupancy or Vacancy sensor using an AV Bridge:

1. Enter Joining mode.
 - a. Press and hold the **SETUP** button for 2 seconds. The LEDs on all devices in the space (except battery powered devices) flash slowly to indicate that the devices are part of the space and that the space is in Joining mode.

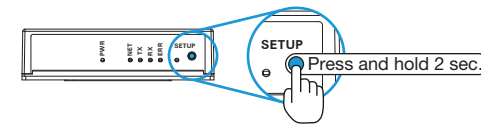

2. Add the occupancy or vacancy sensor.
 - a. Press the **TEST** button 3 times.
 - b. Press and hold the **TEST** button until the LED on the sensor lights to indicate that it has joined the space.

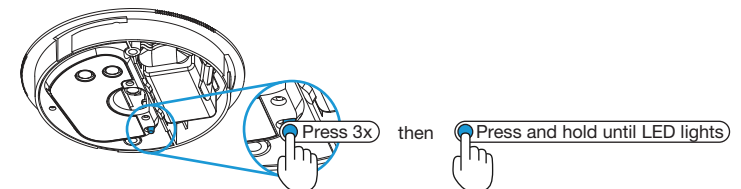

3. Press any button on an AC-powered device that is part of the Züm space to exit Joining mode.

Replace the Battery

The red LED under the dome flashes to indicate that the battery needs to be replaced. Actual battery life depends on device usage. Use the following procedure to replace the battery in the occupancy or vacancy sensor.

CAUTION: The battery used in this device may present a risk of fire or chemical burn if mistreated. Do not recharge, disassemble, heat above 212 °F (100 °C), or incinerate. Replace the battery with an Ultralife 9 volt lithium battery only. Use of another battery may present a risk of fire or explosion.

1. Rotate the cover of the sensor counterclockwise to remove the cover.
2. Remove the battery from the sensor.
3. Disconnect the battery from the two terminals in the sensor.
4. Connect the new battery to the two terminals in the sensor and secure the battery into the housing.
5. Rotate the cover of the sensor clockwise onto the installed base until it is secured in place. The assembly clicks when secured.

NOTE: Dispose of a used battery promptly. Keep away from children. Do not disassemble and do not dispose of in fire.

Factory Reset

Perform a factory reset when the device is removed from the Züm space or to remove the configuration settings. The device must also be factory reset if the device is being moved to a different Züm space.

NOTE: New-in-box devices do not need to be factory reset before joining a system.

To factory reset the occupancy or vacancy sensor, press and hold the **TEST** button until the LED flashes 3 times.

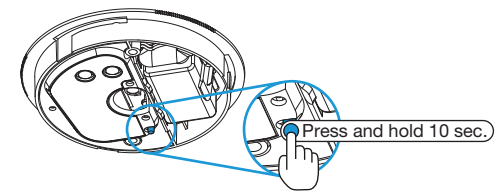

Specifications

SPECIFICATION	DETAILS
Power	
Battery	(1) Ultralife U9VL-J-P 9 Volt 1200 mAh lithium disposable battery (included)
Battery Life	10 years under normal operating conditions
Sensing	
Sensor Technology	Passive infrared
Coverage Area	500 square feet (46.5 square meters)
Coverage Pattern	360 degrees (half mask and perforated mask included)
Major Motion Area	150 to 500 square feet (13.9 to 46.4 square meters)
Minor Motion Area	0 to 150 square feet (0 to 13.9 square meters)
Timeout	(1) Knob (behind cover), adjusts timeout from 30 seconds to 30 minutes; Factory default time delay is 15 minutes
Environmental	
Temperature	32° to 104 °F (0° to 40 °C)
Humidity	10% to 95% RH (non-condensing)

This product is Listed to applicable UL® Standards and requirements tested by Underwriters Laboratories Inc.

Ce produit est homologué selon les normes et les exigences UL applicables par Underwriters Laboratories Inc.



Federal Communications Commission (FCC) Compliance Statement

This device complies with part 15 of the FCC Rules. Operation is subject to the following conditions: (1) This device may not cause harmful interference and (2) this device must accept any interference received, including interference that may cause undesired operation.

CAUTION: Changes or modifications not expressly approved by the manufacturer responsible for compliance could void the user's authority to operate the equipment.

NOTE: This equipment has been tested and found to comply with the limits for a Class B digital device, pursuant to part 15 of the FCC Rules. These limits are designed to provide reasonable protection against harmful interference in a residential installation. This equipment generates, uses and can radiate radio frequency energy and, if not installed and used in accordance with the instructions, may cause harmful interference to radio communications. However, there is no guarantee that interference will not occur in a particular installation. If this equipment does cause harmful interference to radio or television reception, which can be determined by turning the equipment off and on, the user is encouraged to try to correct the interference by one or more of the following measures:

- Reorient or relocate the receiving antenna.
- Increase the separation between the equipment and receiver.
- Connect the equipment into an outlet on a circuit different from that to which the receiver is connected.
- Consult the dealer or an experienced radio/TV technician for help.

Industry Canada (IC) Compliance Statement

This Class B digital apparatus complies with Canadian ICES-003.

Cet appareil numérique de la classe B est conforme à la norme NMB-003 du Canada.

For indoor use only.

The product warranty can be found at www.crestron.com/warranty.

The specific patents that cover Crestron products are listed at www.crestron.com/legal/patents. Certain Crestron products contain open source software. For specific information, please visit www.crestron.com/opensource.

Crestron, the Crestron logo, and Züm are either trademarks or registered trademarks of Crestron Electronics, Inc. in the United States and/or other countries. UL and the UL logo are either trademarks or registered trademarks of Underwriters Laboratories, Inc. in the United States and/or other countries. Other trademarks, registered trademarks, and trade names may be used in this document to refer to either the entities claiming the marks and names or their products. Crestron disclaims any proprietary interest in the marks and names of others. Crestron is not responsible for errors in typography or photography.

This document was written by the Technical Publications department at Crestron.

©2018 Crestron Electronics, Inc.

Crestron Electronics, Inc.
15 Volvo Drive, Rockleigh, NJ 07647
Tel: 888.CRESTRON
Fax: 201.767.7576
www.crestron.com

Installation Guide - DOC. 7867D

(2047763)

07.18

Specifications subject to change without notice.