

Crestron **SWAMP(I)E-8**
Sonnex[®] Multiroom Audio Expander,
8 Zone

Operations Guide



Important Safety Instructions

- Read these instructions.
- Keep these instructions.
- Heed all warnings.
- Follow all instructions.
- Do not use this apparatus near water.
- Clean only with dry cloth.
- Do not block any ventilation openings. Install in accordance with the manufacturer's instructions.
- Do not install near any heat sources such as radiators, heat registers, stoves, or other apparatus (including amplifiers) that produce heat.
- Do not defeat the safety purpose of the polarized or grounding-type plug. A polarized plug has two blades with one wider than the other. A grounding-type plug has two blades and a third grounding prong. The wide blade or the third prong are provided for your safety. If the provided plug does not fit into your outlet, consult an electrician for replacement of the obsolete outlet.
- Protect the power cord from being walked on or pinched particularly at plugs, convenience receptacles, and the point where they exit from the apparatus.
- Only use attachments/accessories specified by the manufacturer.
- Use only with the cart, stand, tripod, bracket or table specified by the manufacturer or sold with the apparatus. When a cart is used, use caution when moving the cart/apparatus combination to avoid injury from tip-over. 
- Unplug this apparatus during lightning storms or when unused for long periods of time.
- Refer all servicing to qualified service personnel. Servicing is required when the apparatus has been damaged in any way, such as power-supply cord or plug is damaged, liquid has been spilled or objects have fallen into the apparatus, the apparatus has been exposed to rain or moisture, does not operate normally, or has been dropped.
- Disconnect power prior to connecting or disconnecting equipment.
- Do not install in direct sunlight.
- The apparatus must be installed in a way that the power cord can be removed either from the wall outlet or from the device itself in order to disconnect the mains power.
- Prevent foreign objects from entering the device.

WARNING:

TO REDUCE THE RISK OF FIRE OR ELECTRIC SHOCK, DO NOT EXPOSE THIS APPARATUS TO RAIN OR MOISTURE. THE APPARATUS SHALL NOT BE EXPOSED TO DRIPPING OR SPLASHING. OBJECTS FILLED WITH LIQUIDS, SUCH AS VASES, SHOULD NOT BE PLACED ON THE APPARATUS.

WARNING:

TO PREVENT ELECTRIC SHOCK, DO NOT REMOVE COVER. THERE ARE NO USER SERVICEABLE PARTS INSIDE. ONLY QUALIFIED SERVICE PERSONNEL SHOULD PERFORM SERVICE.

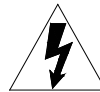

The lightning flash with arrowhead symbol, within an equilateral triangle, is intended to alert the user to the presence of uninsulated "dangerous voltage" within the product's enclosure that may be of sufficient magnitude to constitute a risk of electric shock to persons.

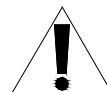

The exclamation point within an equilateral triangle is intended to alert the user to the presence of important operating and maintenance (servicing) instructions in the literature accompanying the appliance.

WARNING:

THIS IS AN APPARATUS WITH CLASS I CONSTRUCTION. IT SHALL BE CONNECTED TO AN ELECTRICAL OUTLET WITH AN EARTHING GROUND TERMINAL.

IMPORTANT:

These devices can be used with Class 2 output wiring.

Regulatory Compliance

These products conform to UL 60065; certified to CSA C22.2 No. 60065.03.



As of the date of manufacture, the SWAMPE-8 and SWAMPIE-8 have been tested and found to comply with specifications for CE marking.



Federal Communications Commission (FCC) Compliance Statement

This device complies with part 15 of the FCC Rules. Operation is subject to the following conditions:

(1) This device may not cause harmful interference and (2) this device must accept any interference received, including interference that may cause undesired operation.

CAUTION: Changes or modifications not expressly approved by the manufacturer responsible for compliance could void the user's authority to operate the equipment.

NOTE: This equipment has been tested and found to comply with the limits for a Class B digital device, pursuant to part 15 of the FCC Rules. These limits are designed to provide reasonable protection against harmful interference in a residential installation. This equipment generates, uses and can radiate radio frequency energy and, if not installed and used in accordance with the instructions, may cause harmful interference to radio communications. However, there is no guarantee that interference will not occur in a particular installation. If this equipment does cause harmful interference to radio or television reception, which can be determined by turning the equipment off and on, the user is encouraged to try to correct the interference by one or more of the following measures:

- Reorient or relocate the receiving antenna
- Increase the separation between the equipment and receiver
- Connect the equipment into an outlet on a circuit different from that to which the receiver is connected
- Consult the dealer or an experienced radio/TV technician for help

Industry Canada (IC) Compliance Statement

CAN ICES-3(B)/NMB-3(B)

The specific patents that cover Crestron products are listed at patents.crestron.com.

Crestron, the Crestron logo, AIR, Aspire, Cresnet, Essence, Excite, Saros, Sonnex, Sonnex Speaker Protect, and SSP are either trademarks or registered trademarks of Crestron Electronics, Inc. in the United States and/or other countries. Blu-ray Disc is either a trademark or registered trademark of the Blu-ray Disc Association (BDA) in the United States and/or other countries. Other trademarks, registered trademarks, and trade names may be used in this document to refer to either the entities claiming the marks and names or their products. Crestron disclaims any proprietary interest in the marks and names of others. *Crestron is not responsible for errors in typography or photography.*

This document was written by the Technical Publications department at Crestron.
©2014 Crestron Electronics, Inc.

Contents

Sonnex Multiroom Audio Expander, 8 Zone: SWAMP(I)E-8	1
Introduction	1
Features and Functions	1
Applications.....	3
Specifications	3
Physical Description.....	6
Setup.....	9
Sonnex Link Wiring	9
Installation.....	9
Hardware Hookup	11
Configuration.....	16
Uploading and Upgrading.....	17
Establishing Communication.....	17
Programs and Firmware	17
Operation	18
Problem Solving	19
Troubleshooting.....	19
Check Wiring	19
Reference Documents.....	19
Further Inquiries	19
Future Updates	20
Return and Warranty Policies	21
Merchandise Returns / Repair Service	21
Crestron Limited Warranty.....	21

Sonnex Multiroom Audio Expander, 8 Zone: SWAMP(I)E-8

Introduction

The SWAMPE-8 is an 8-zone expander for the Sonnex[®] Multiroom Audio System (SWAMP-24X8)* from Crestron[®]. It adds eight stereo amplified zones to the Sonnex system, with the option for installation at the central equipment rack or at a remote location near the rooms it serves. The latter “decentralized” approach has the benefit of minimizing the amount of speaker wiring required, affording higher performance and efficiency and a faster, easier, and less expensive installation.

The SWAMPE-8 and SWAMPIE-8 are functionally identical. For simplicity within this guide, the term “SWAMPE-8” is used except where noted.

Features and Functions

- Eight-zone Sonnex expansion with amplified outputs
- 140 watts/channel @ 8 ohms, 400 watts/channel bridged
- 70/100 volt “constant-voltage” output options available
- Advanced DSP, mono summing, and output bussing per zone
- Sonnex Speaker Protect™
- Individual zone power control and global standby
- Remote fault monitoring
- Heavy duty detachable terminal blocks
- Single-cable interface to SWAMP-24X8 via Sonnex Link
- Plug-and-play operation
- Low power consumption, cool-running operation
- Three-space rack mountable

Integrated Audiophile Amplifier

The SWAMPE-8 features the same custom hybrid amplifier design as the SWAMP-24X8, delivering the warmth and neutrality of a fine Class AB amplifier with all the efficiency benefits of a modern Class D. Each of its 16 channels (configured as eight stereo zones) delivers 140 watts into 8 ohms or 240 watts into 4 ohms, and any two adjacent outputs can be bridged to produce 400 watts per channel at 8 ohms. Even with such incredible power, the SWAMPE-8 runs coolly and efficiently and requires only three rack spaces for mounting. Each zone is individually controllable to save energy by turning off any unused channels.

* Sold separately.

Digital Signal Processing

Each zone features independent DSP for optimal sound quality and control in every room. Sonnex DSP capabilities include graphic or parametric 5-band EQ, dynamic range control, volume, bass, treble, balance, loudness, mute, mono summing, and five selectable tone profiles. For passive subwoofer applications, a choice of second or fourth order active crossover filters can be set using the parametric EQ, leaving the four remaining EQ filters available for room correction and tonal enhancement.

Output Bussing

Output bussing allows multiple zones to function as one, whether fed from the SWAMPE-8, the SWAMP-24X8, or another Sonnex Expander. Output bussing is ideal for grouping adjacent listening areas together or associating a subwoofer with its stereo speaker pair. Volume offset adjustments allow for balancing the levels of each bussed zone for smooth, even coverage.

70/100V Option

Any zone output can be converted to 70 or 100 volt output using one or more Sonnex Output Transformers (SAT-70V/100V-2 or SAT-70V/100V-4¹). Also known as “constant-voltage”, 70 volt and 100 volt speaker systems allow for long wire runs using small-gauge wire, with the potential for connecting numerous speakers per circuit. Typical applications include outdoor speaker zones, commercial retail spaces, hallways, and common areas.

Simple, Versatile Installation

The SWAMPE-8 can be installed along with the SWAMP-24X8 at the central equipment rack or separately at a remote location. It interfaces with the SWAMP-24X8 via a single CAT5e shielded twisted pair (STP) cable up to 200 ft (61 m) in length.² This length can be increased to 2000 ft (610 m) using multimode fiber optic cable with the S-EXT1-S Sonnex Link over Fiber Extender.¹ Plug-and-play connectivity affords an extremely easy installation with full control access to all the SWAMPE-8 functions provided through the SWAMP-24X8.

1. Item(s) sold separately.
2. For connection of the Sonnex Link between the SWAMPE-8 and SWAMP-24X8, use Crestron DM-CBL-8G or high-quality CAT5e shielded twisted-pair cable (sold separately). The maximum cable length using DM-CBL-8G or CAT5e is 200 ft (61 m). For longer distances, use the S-EXT1-S Sonnex Link over Fiber Extender (sold separately).

Applications

The following diagram shows a SWAMPE-8 in a multizone application.

SWAMPE-8 in a Multizone Application

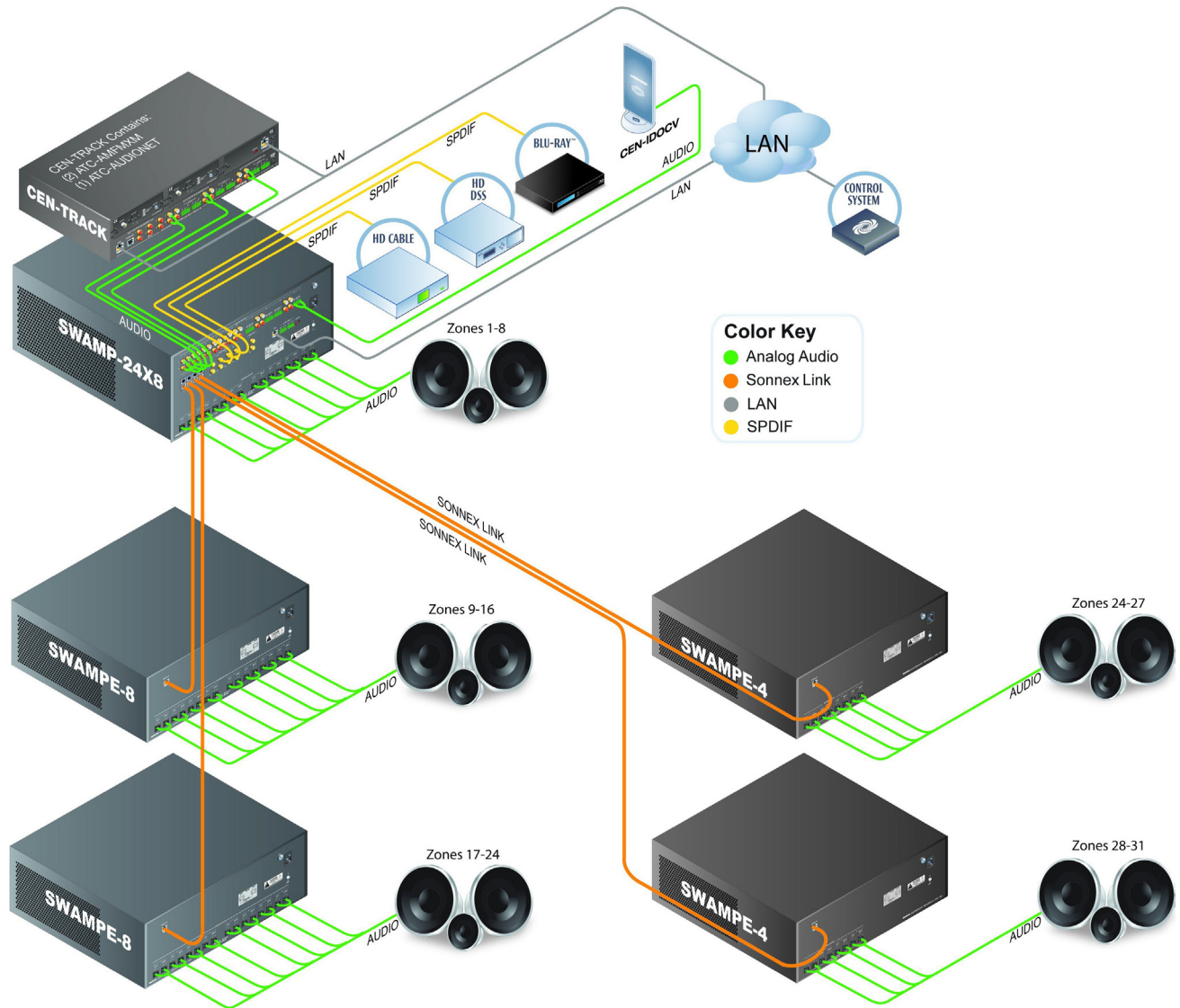

Specifications

Specifications for the SWAMPE-8 are listed in the following table.

SWAMPE-8 Specifications

SPECIFICATION	DETAILS
Audio	
Input Signal Types	Sonnex Link
Output Signal Types	Stereo speaker level
Digital-to-Analog Conversion ¹	24-bit 48 kHz
Output Power ¹	140 watts per channel at 8 ohms; 240 watts per channel at 4 ohms; 400 watts per channel at 8 ohms bridged
Damping Factor ¹	> 200 @ 20 Hz
Amplifier Monitoring ¹	Over current, over/under voltage, over temperature, dc offset, clipping
Frequency Response ¹	20 Hz to 20 kHz, ± 0.5 dB
Total Harmonic Distortion (THD) ¹	0.02%
S/N Ratio ¹	> 105 dB S/PDIF in, > 100 dB balanced or unbalanced analog in, A-weighted
Stereo Separation ¹	> 90 dB
Zone Separation ¹	> 95 dB
Zone Volume Level Control ¹	-80.0 to +20.0 dB, adjustable from 0% to 100% plus mute
Bass Control ¹	± 12.0 dB
Treble Control ¹	± 12.0 dB
Loudness Compensation ¹	On/Off
Dynamic Range Control ¹	On/Off
Balance Control ¹	Left/right adjustable
Mono Summing ¹	Selectable
Power Limiting ¹	Sonnex Speaker Protect (SSP [®]) output limiting; ² Configurable 40 to 140 watts @ 8 ohms; 40 to 240 watts @ 4 ohms; 40 to 400 watts @ 8 ohms bridged
Tone Profiles ¹	Flat, Classical, Jazz, Pop, Rock, Spoken Word
EQ Modes ¹	5-band graphic or 5-band parametric EQ
GEQ Center Frequencies ¹	63 Hz, 250 Hz, 1 kHz, 4 kHz, 16 kHz
GEQ Gain ¹	± 12.0 dB per band
PEQ Filter Types	EQ, High Pass, Low Pass, Treble Shelf, Bass Shelf, Notch
PEQ Center Frequency ¹	10 Hz to 20 kHz per band
PEQ Gain ¹	± 12.0 dB per band
PEQ Bandwidth ¹	0.1 to 3.5 octaves per band

(Continued on following page)

SWAMPE-8 Specifications (Continued)

SPECIFICATION	DETAILS
Audio (Continued) Speaker Profiles ¹ Bus Volume Offset ¹	Comprises 5-band GEQ and SSP settings ±12.0 dB per zone for output bussing
Communications Sonnex Link	64-channel (48 utilized) digital audio with embedded control, auto-discovery, auto-negotiating
Power Requirements Main Power SWAMPE-8 SWAMPIE-8	12 amps @ 120 volts ac, 50/60 Hz (a dedicated 15 amp circuit is strongly recommended) 6 amps @ 220-240 volts ac, 50/60 Hz (a dedicated 10 amp circuit is strongly recommended)
Environmental Temperature Humidity Heat Dissipation	41° to 104°F (5° to 40°C) 10% to 90% RH (non-condensing) 475 Btu/h (140 W @ 8 ohms) 750 Btu/h (240 W @ 4 ohms)
Enclosure Chassis Front Panel Mounting	Metal with black finish, vented sides, variable-speed fan-cooled Metal, black finish with polycarbonate label overlay Freestanding or 3U 19-inch rack-mountable (feet and rack ears included)
Dimensions Height Width Depth	5.83 in (149 mm) with feet 5.20 in (133 mm) without feet 19.00 in (483 mm) with ears 17.29 in (439 mm) without ears 18.22 in (463 mm)
Weight	60.0 lb (27.3 kg)
Available Models SWAMPE-8 SWAMPIE-8	Sonnex Multiroom Audio Expander, 8-Zone Sonnex Multiroom Audio Expander – International Version, 8-Zone

(Continued on following page)

SWAMPE-8 Specifications (Continued)

SPECIFICATION	DETAILS
Available Accessories	
AIR Series	AIR® Outdoor Speakers
ASPIRE Series	Aspire® Speakers
DM-8G-CONN	Cable Connector for DM-CBL-8G
DM-8G-CONN-WG	Cable Connector with Wire Guide for DM-CBL-8G
DM-8G-CRIMP	Crimping Tool for DM-8G-CONN
DM-8G-CRIMP-WG	Crimping Tool for DM-8G-CONN-WG
DM-CBL-8G	High Performance CAT5e Shielded Twisted Pair Cable
ESSENCE Series	Essence® Speakers
EXCITE Series	Excite® Speakers
S-EXT1-S	Sonnex Link over Fiber Extender
SAROS Series	Saros® Speakers
SAT-70V/100V	Sonnex Output Transformer
SWAMP(I)-24X8	Sonnex Multiroom Audio System

1. Typical of up to eight amplified stereo zone outputs.
2. As speaker ratings vary greatly across manufacturers, there is no guarantee that Sonnex Speaker Protect protects against speaker damage in all situations.

Physical Description

This section provides information on the connections, controls, and indicators available on the SWAMPE-8.

SWAMPE-8 Physical View (Front)







SWAMPE-8 Physical View (Rear)

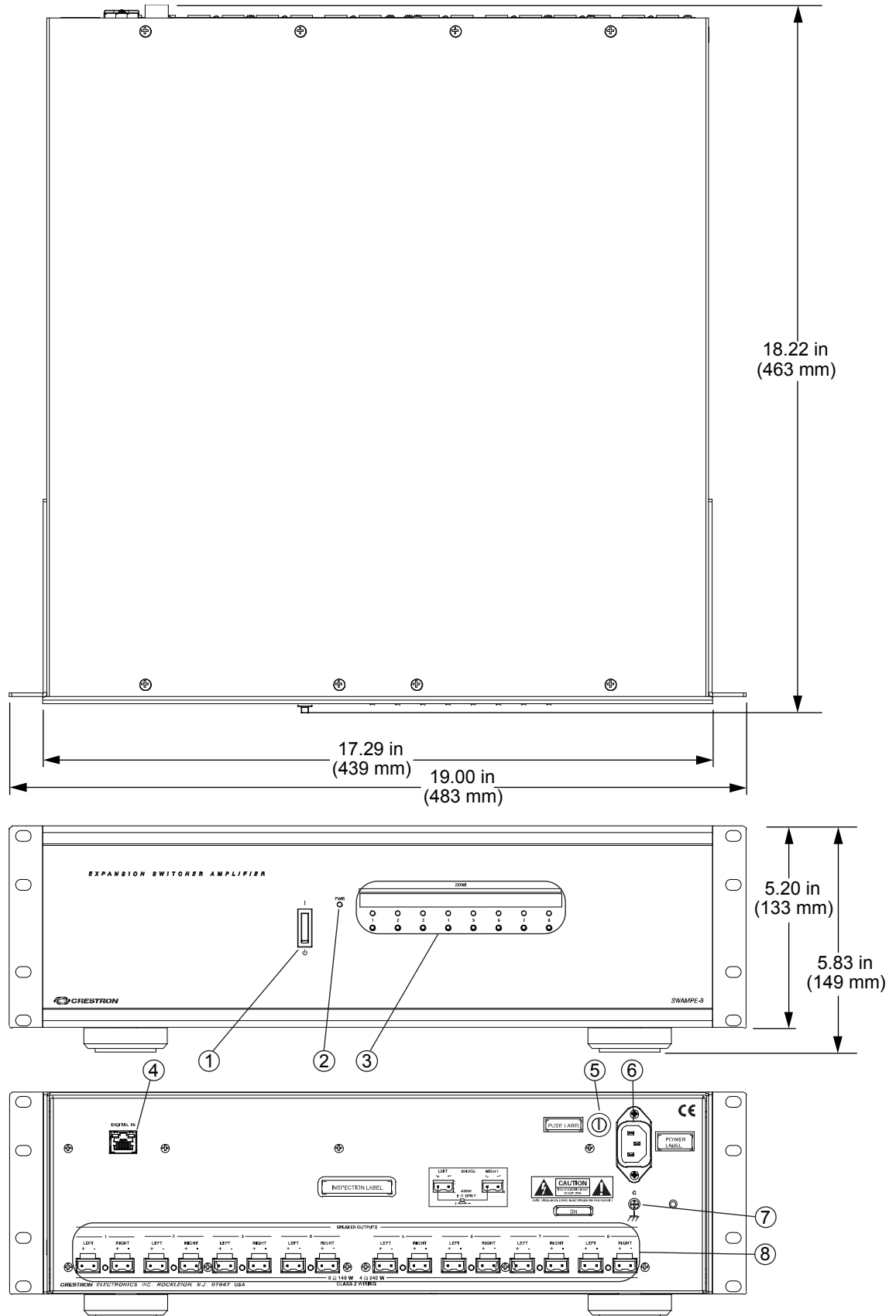

SWAMPE-8 Overall Dimensions

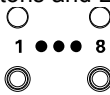
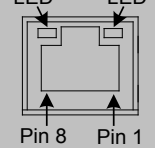

Connectors, Controls, and Indicators

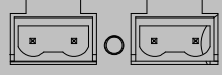
#	CONNECTORS, ¹ CONTROLS, AND INDICATORS	DESCRIPTION
1	On/Off 	(1) Rocker switch, turns unit on and off
2	PWR LED	(1) Green LED indicates unit is turned on
3	ZONE (1-8) Buttons and LEDs 	(8) Push buttons and green LEDs, select output zone for routing and adjustment
4	DIGITAL IN Green LED Yellow LED 	(1) 8-wire RJ-45 female; Sonnex link input; Connects to SWAMP-24X8 Multiroom Audio System ² or S-EXT1-S Sonnex Link over Fiber Extender ² (each sold separately) Green LED indicates link status; Amber LED indicates data communication
5	FUSE 	The SWAMPE-8 requires a T15AH (1/4 in x 1-1/4 in, 250 V, 15 A, time-lag, high-rupture rated) fuse, ³ The SWAMPIE-8 requires a T8AH (5 mm x 20 mm, 250 V, 8 A, time-lag, high-rupture rated) fuse ³
6	120V~50/60Hz MAX 12A ⁴ 	(1) IEC 60320 C14, main power inlet; Mates with removable power cord (included)
7	GROUND 	(1) 6-32 screw, chassis ground lug
8	SPEAKER OUTPUTS (1-8) LEFT RIGHT + - + - 	(16) 2-pin 7.62 mm 15A detachable terminal blocks; Power amplifier outputs; Wire Size: Terminals accept up to 14 AWG; The following outputs can be bridged together: 1 and 2 (L+R), 3 and 4 (L+R), 5 and 6 (L+R), and 7 and 8 (L+R); (8) Red LEDs, indicate adjacent outputs are configured for bridged operation NOTE: Outputs can only be bridged into an 8 ohm load.

1. Interface connectors for SPEAKER OUTPUTS ports are provided with the unit.
2. For connection of the Sonnex Link between the SWAMPE-8 and the SWAMP-24X8 or S-EXT1-S, use Crestron DM-CBL-8G or high-quality CAT5e shielded twisted-pair cable (sold separately). The maximum cable length is 200 ft (61 meters) per run.
3. Refer to "Fuse Replacement" on page 14 for additional details.
4. Port on SWAMPIE-8 is labeled 220-240V~50/60Hz MAX 6A.

Setup

Sonnex Link Wiring

Crestron recommends using Crestron DM-CBL-8G or high-quality CAT5e shielded twisted-pair cable (sold separately) for Sonnex Link connections between the SWAMPE-8 and the SWAMP-24X8 or S-EXT1-S.

NOTE: Shielded connectors such as the DM-8G-CONN (sold separately) must be used.

DM-CBL-8G wire can carry Sonnex Link signals up to 200 feet (61 meters).

Installation

Ventilation

The SWAMPE-8 should be used in a well-ventilated area. The venting holes should not be obstructed under any circumstances.

To prevent overheating, do not operate this product in an area that exceeds the environmental temperature range listed in the table of specifications. Consider using forced air ventilation or increasing the spacing between units to reduce overheating. Contact with thermal insulating materials should be avoided on all sides of the unit.

Rack Mounting

The SWAMPE-8 can be mounted in a rack or stacked with other equipment. Two “ears” are provided with the SWAMPE-8 so that the unit can be rack mounted. These ears must be installed prior to mounting. Complete the following procedure to attach the ears to the unit. The only tool required is a #1 or #2 Phillips screwdriver.

WARNING: To prevent bodily injury when mounting or servicing this unit in a rack, observe the following guidelines:

- When mounting this unit in a partially filled rack, load the rack from the bottom to the top with the heaviest component at the bottom of the rack.
- If the rack is provided with stabilizing devices, install the stabilizers before mounting or servicing the unit in the rack.

NOTE: Observe the following guidelines when installing equipment in a rack:

- Elevated Operating Ambient Temperature - If installed in a closed or multi-unit rack assembly, the operating ambient temperature of the rack environment may be greater than room ambient temperature. Therefore, consideration should be given to installing the equipment in an environment compatible with the maximum ambient temperature (T_{ma}) specified by the manufacturer.
- Reduced Air Flow - Installation of the equipment in a rack should be such that the amount of airflow required for safe operation of the equipment is not compromised.
- Mechanical Loading - Mounting of the equipment in the rack should be such that a hazardous condition is not achieved due to uneven mechanical loading.
- Circuit Overloading - Consideration should be given to the connection of the equipment to the supply circuit and the effect that overloading of the circuits might have on overcurrent protection and supply wiring.

Appropriate consideration of equipment nameplate ratings should be used when addressing this concern.

- **Reliable Earthing** - Reliable earthing of rack-mounted equipment should be maintained. Particular attention should be given to supply connections other than direct connections to the branch circuit (e.g., use of power strips).

NOTE: Feet are preinstalled for tabletop mounting or stacking. If the unit is to be rack mounted, the feet are not required and can be removed to provide more space in the rack.

To install the ears, use the following procedure.

CAUTION: To prevent equipment damage, use only the rack ears Crestron provides for this device.

1. There are screws that secure each side of the SWAMPE-8 top cover. Using a #1 or #2 Phillips screwdriver, remove the three screws closest to the front panel from one side of the unit. Refer to the diagram following step 3 for a detailed view.
2. Position a rack ear so that its mounting holes align with the holes vacated by the screws in step 1.
3. Secure the ear to the unit with three screws from step 1, as shown in the following diagram.

Ear Attachment for Rack Mounting

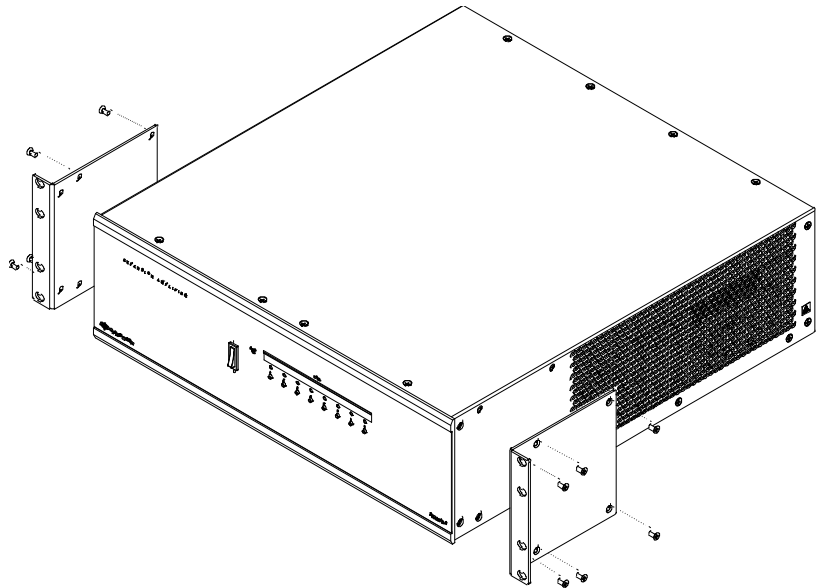

4. Repeat the procedure (steps 1 through 3) to attach the remaining ear to the opposite side.

Stacking

Four “feet” are preinstalled with the SWAMPE-8 so that if the unit is not rack mounted, the feet can provide stability when the unit is placed on a flat surface or stacked.

NOTE: No more than two SWAMPE-8 units should be stacked.

Hardware Hookup

Connect the Device

Make the necessary connections as called out in the illustration that follows this paragraph. Refer to “Sonnex Link Wiring” on page 9 for additional information. Apply power after all connections have been made.

Hardware Connections for the SWAMPE-8

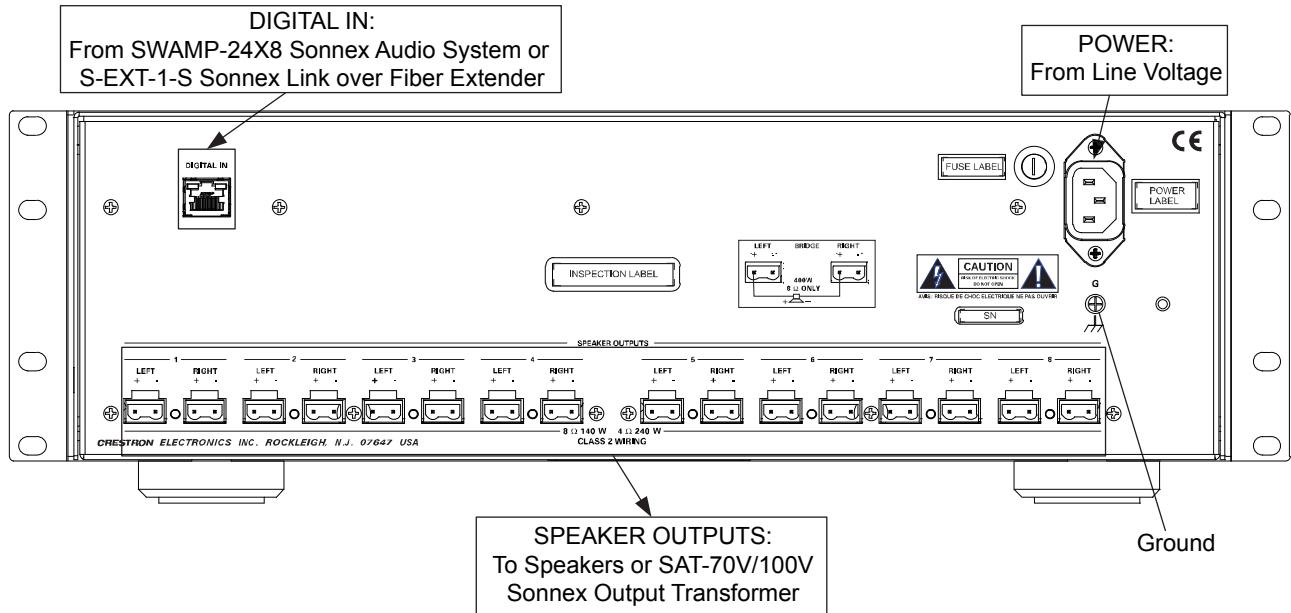

CAUTION: Keep the device unplugged until all the input and speaker wiring is complete.

CAUTION: Check the speaker wires for shorts and frayed wiring around the SPEAKER OUTPUTS connectors.

NOTE: When installing the SWAMPE-8, a dedicated 15 amp circuit is strongly recommended. When installing the SWAMPIE-8, a dedicated 10 amp circuit is strongly recommended.

NOTE: Ensure the unit is properly grounded by connecting the chassis ground lug to an earth ground (building steel).

NOTE: To prevent overheating, do not operate this product in an area that exceeds the environmental temperature range listed in the table of specifications.

Speaker Connections

Make speaker connections to the SWAMPE-8 as shown in the following diagram.

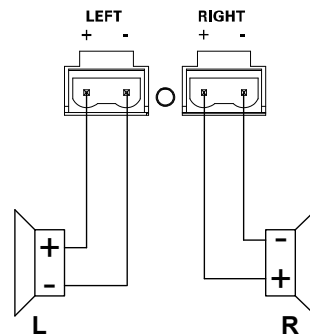
Speaker Connections

NOTE: If the SAT-70V/100V Sonnex Output Transformer (sold separately) is connected to a speaker terminal, use the SAT-70V/100V profile built into the Sonnex Tools application to configure a high-pass filter on the zone that is connected to SAT-70V/100V. For details, refer to the Sonnex Tools help file.

Bridge Speaker Outputs (Optional)

The speaker outputs on the SWAMPE-8 can be bridged to deliver higher power to a speaker. The left channel on an individual output can be bridged with the right channel on the same output. Refer to the following diagram when bridging outputs.

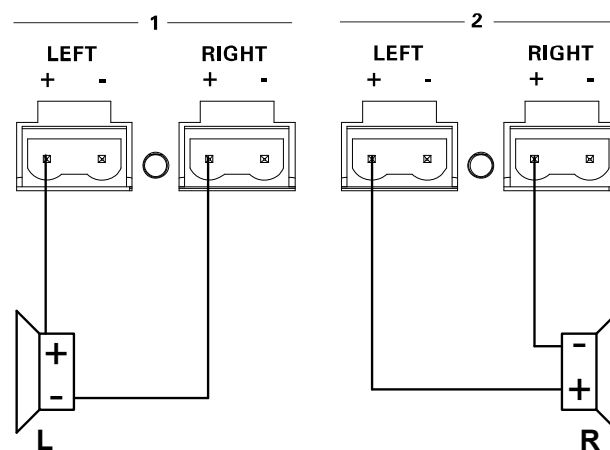
Bridging Outputs

The possible bridging combinations are: Zone 1 + Zone 2, Zone 3 + Zone 4, Zone 5 + Zone 6, Zone 7 + Zone 8. LEDs on the back of the SWAMPE-8 indicate bridged outputs.

After the zones are wired for bridged operation, the SWAMPE-8 must be configured with the SWAMP-24X8's **Installer Mode** menu or with the Sonnex Tools application. Refer to the SWAMP(I)-24X8 Sonnex Multiroom Audio System Operations Guide (Doc. 7049) at www.crestron.com/manuals or the Sonnex Tools help file for more information.

WARNING: This device is capable of delivering immense amounts of undistorted power to connected loudspeakers. Please use caution and adequate ear protection if listening to content at high volume levels as continued exposure to high sound pressure levels can cause permanent hearing impairment or loss.

Subwoofer Applications
(Optional)

Using a sound level (SPL) meter and Sonnex Tools, outputs on SWAMPE-8 can be used to deliver sound to a left-right stereo pair and subwoofer speaker layout. There are two different wiring configurations that can be used.

Wiring Diagram: Passive Subwoofer Using an Additional Output Pair

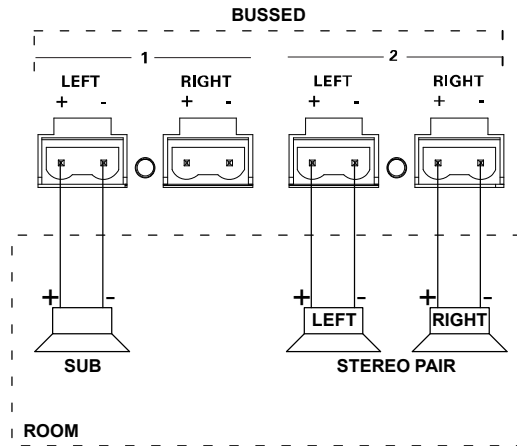

NOTE: In this diagram, output 1 and output 2 are used. However, other outputs (either on the SWAMP-24X8 or the SWAMPE-8) can be used.

Wiring Diagram: Passive Subwoofer Using Bridged Output

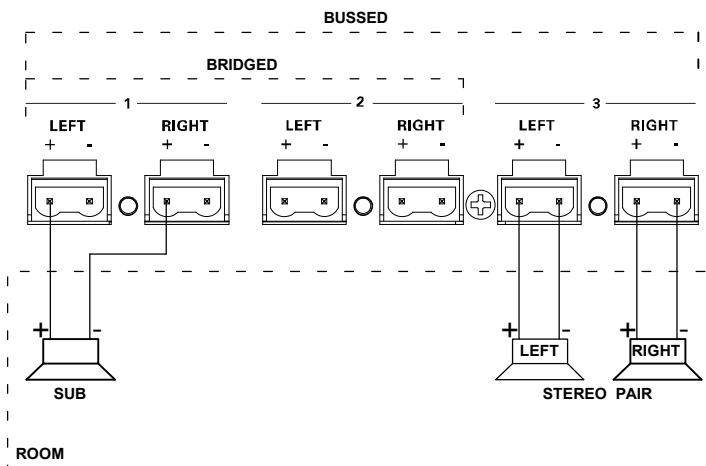

NOTE: In this diagram, output 1, output 2, and output 3 are used. However, other outputs (either on the SWAMP-24X8 or the SWAMPE-8) can be used as long as the bridged zones for the subwoofer are adjacent to each other (either on the SWAMP-24X8 or the SWAMPE-8).

Perform the following procedure:

1. Connect the speakers and subwoofer as shown in one of the previous diagrams.
2. Refer to the SWAMP(I)-24X8 Sonnex Multiroom Audio System Operations Guide (Doc. 7049) for configuration details.

Connect to SWAMP24X8 or S-EXT1-S Sonnex Link over Fiber Extender

The SWAMPE-8 can be connected to a SWAMP-24X8 (sold separately) or S-EXT1-S Sonnex Link over Fiber Extender (sold separately) via shielded CAT5 cable.

SWAMP-24X8 to SWAMPE-8 Connection

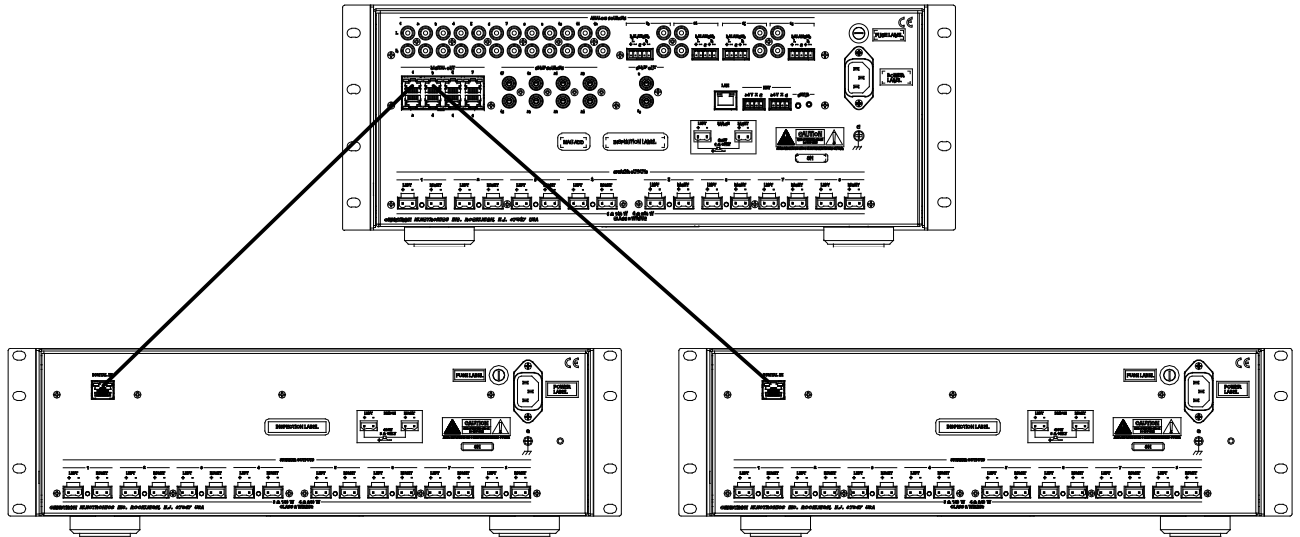

NOTE: When the SWAMP-24X8 is connected to a control system using Cresnet[®], only one expander can be connected.

NOTE: When connecting a SWAMP-24X8 or S-EXT1-S to a SWAMPE-8, Crestron recommends using Crestron DM-CBL-8G or high-quality CAT5e shielded twisted-pair cable. Shielded connectors such as the DM-8G-CONN (sold separately) must be used.

NOTE: The maximum cable length between a SWAMP-24X8 or S-EXT1-S and SWAMPE-8 is 200 feet (61 meters).

Fuse Replacement

If the SWAMPE-8 does not power up when it is plugged into an ac outlet and the power switch is engaged, the fuse may need to be replaced. The fuse holder is located on the rear panel, above and to the left of the IEC socket assembly. Perform the following to replace the fuse:

1. Disconnect power to the SWAMPE-8.
2. Use a flat head screwdriver to push in the fuse holder.
3. While pushing in the fuse holder, turn the screwdriver counterclockwise until the fuse holder pops out.
4. Remove the fuse from the fuse holder and insert a new fuse.

CAUTION: Use only the specified type of fuse. Failure to do so may cause damage to the SWAMPE-8.

NOTE: Two spare fuses are included.

SWAMPE-8 MODEL	REQUIRED FUSE TYPE
SWAMPE-8 (US & Canada)	T15AH (1/4 in x 1-1/4 in, 250 V, 15 A, time-lag, high-rupture rated)
SWAMPIE-8 (International/220-240 VAC)	T8AH (5 mm x 20 mm, 250 V, 8 A, time-lag, high-rupture rated)

5. Insert the fuse holder into the SWAMPE-8.
6. Push in the fuse holder with a flat head screwdriver. While pushing in the fuse holder, turn the screwdriver clockwise until the fuse holder sets into place.
7. Push in the fuse holder a little further and turn the screwdriver clockwise until the fuse holder locks in place.
8. Connect power to the SWAMPE-8.

Label the Buttons

Use Crestron Engraver software to print custom labels for the SWAMPE-8's front panel buttons and LEDs. Crestron recommends printing on 100-pound paper. Paper weighing less than 100 pounds tends to crumple while sliding in, while paper weighing more than 100 pounds may not fit.

Configuration

The SWAMPE-8 is automatically configured from the front panel of a connected SWAMP-24X8 or by Sonnex Tools software. For more information on configuration options, refer to the SWAMP(I)-24X8 Sonnex Multiroom Audio System Operations Guide (Doc. 7049).

Uploading and Upgrading

Crestron recommends using the latest programming software and that each device contains the latest firmware to take advantage of the most recently released features. However, before attempting to upload or upgrade it is necessary to establish communication.

Establishing Communication

All communication with the SWAMPE-8 is managed through the communication link with a connected SWAMP-24X8. For information, refer to the SWAMP(I)-24X8 Sonnex Multiroom Audio System Operations Guide (Doc. 7049).

Programs and Firmware



Any program or firmware updates are managed by the connection with the SWAMP-24X8. For information, refer to the SWAMP(I)-24X8 Sonnex Multiroom Audio System Operations Guide (Doc. 7049).

Operation

The SWAMPE-8 operates in either the Zone mode or the Source mode. The SWAMPE-8's operating mode is determined by the operating mode of the SWAMP-24X8.

For information on operating the SWAMP-24X8, refer to the SWAMP(I)-24X8 Sonnex Multiroom Audio System Operations Guide (Doc. 7049).

Power

Turn on the SWAMPE-8 by moving the On/Off switch to . To turn off the SWAMPE-8, move the On/Off switch to .

Zone Mode

The Zone mode uses the SWAMP-24X8's front panel to route a source signal to a selected zone. Perform the following to enter the Zone mode:

1. Place the SWAMP-24X8 in the Zone mode.
2. Press the **ZONE** button of the zone to be controlled.
3. Press the **SOURCE** button of the source to be routed. The associated **SOURCE** and **ZONE** LEDs light.

Alternatively, press the **ZONE** button twice to turn on the zone and connect the last selected source.

Source Mode

The Source mode uses the SWAMP-24X8's front panel to select a source signal and route it to multiple zones. Perform the following to enter the Source mode:

1. Place the SWAMP-24X8 in the Source mode.
2. On the SWAMP-24X8, press the **SOURCE** button of the source to be routed. The associated **SOURCE** LED lights.
3. On the SWAMPE-8, press the **ZONE** buttons of the zones to be selected. The associated **ZONE** LED(s) lights.

To remove a zone from a source, press the desired **ZONE** button. The associated **ZONE** LED turns off.

Problem Solving

Troubleshooting

The following table provides corrective action for possible trouble situations. If further assistance is required, please contact a Crestron customer service representative.

SWAMPE-8 Troubleshooting

TROUBLE	POSSIBLE CAUSE(S)	CORRECTIVE ACTION
Audio dropouts are heard on a SWAMPE output zone.	There is a bad (or missing) shield on the Sonnex cable connecting the SWAMP-24X8 and the peripheral device.	Ensure continuity and integrity of shield on both ends of the Sonnex cable.
Device loses functionality due to electrostatic discharge.	Device is improperly grounded.	Check that all ground connections have been made properly.
An incorrect audio signal is heard.	Signal is incorrectly routed.	Reroute the signal.
	Zone is incorrectly bussed with other zone(s).	Remove the zone from the bus.

Check Wiring

To ensure optimum performance over the full range of the installation topology, use Crestron Certified Wire. Failure to do so may incur additional charges if support is required to identify performance deficiencies because of using improper wire.

Reference Documents

All documents mentioned in this guide are available at www.crestron.com/manuals.

List of Related Reference Documents

DOCUMENT TITLE
SWAMP(I)-24X8 Sonnex Multiroom Audio System

Further Inquiries

To locate specific information or resolve questions after reviewing this guide, contact Crestron's True Blue Support at 1-888-CRESTRON [1-888-273-7876] or, for assistance within a particular geographic region, refer to the listing of Crestron worldwide offices at www.crestron.com/offices.

To post a question about Crestron products, log onto Crestron's Online Help at www.crestron.com/onlinehelp. First-time users must establish a user account to fully benefit from all available features.

Future Updates

As Crestron improves functions, adds new features, and extends the capabilities of the SWAMPE-8, additional information may be made available as manual updates. These updates are solely electronic and serve as intermediary supplements prior to the release of a complete technical documentation revision.

Check the Crestron website periodically for manual update availability and its relevance. Updates are identified as an “Addendum” in the Download column.

Return and Warranty Policies

Merchandise Returns / Repair Service

1. No merchandise may be returned for credit, exchange or service without prior authorization from Crestron. To obtain warranty service for Crestron products, contact an authorized Crestron dealer. Only authorized Crestron dealers may contact the factory and request an RMA (Return Merchandise Authorization) number. Enclose a note specifying the nature of the problem, name and phone number of contact person, RMA number and return address.
2. Products may be returned for credit, exchange or service with a Crestron Return Merchandise Authorization (RMA) number. Authorized returns must be shipped freight prepaid to Crestron, 6 Volvo Drive, Rockleigh, N.J. or its authorized subsidiaries, with RMA number clearly marked on the outside of all cartons. Shipments arriving freight collect or without an RMA number shall be subject to refusal. Crestron reserves the right in its sole and absolute discretion to charge a 15% restocking fee plus shipping costs on any products returned with an RMA.
3. Return freight charges following repair of items under warranty shall be paid by Crestron, shipping by standard ground carrier. In the event repairs are found to be non-warranty, return freight costs shall be paid by the purchaser.

Crestron Limited Warranty

Crestron Electronics, Inc. warrants its products to be free from manufacturing defects in materials and workmanship under normal use for a period of three (3) years from the date of purchase from Crestron, with the following exceptions: disk drives and any other moving or rotating mechanical parts, pan/tilt heads and power supplies are covered for a period of one (1) year; touch screen display and overlay components are covered for 90 days; batteries and incandescent lamps are not covered.

This warranty extends to products purchased directly from Crestron or an authorized Crestron dealer. Purchasers should inquire of the dealer regarding the nature and extent of the dealer's warranty, if any.

Crestron shall not be liable to honor the terms of this warranty if the product has been used in any application other than that for which it was intended or if it has been subjected to misuse, accidental damage, modification or improper installation procedures. Furthermore, this warranty does not cover any product that has had the serial number altered, defaced or removed.

This warranty shall be the sole and exclusive remedy to the original purchaser. In no event shall Crestron be liable for incidental or consequential damages of any kind (property or economic damages inclusive) arising from the sale or use of this equipment. Crestron is not liable for any claim made by a third party or made by the purchaser for a third party.

Crestron shall, at its option, repair or replace any product found defective, without charge for parts or labor. Repaired or replaced equipment and parts supplied under this warranty shall be covered only by the unexpired portion of the warranty.

Except as expressly set forth in this warranty, Crestron makes no other warranties, expressed or implied, nor authorizes any other party to offer any warranty, including any implied warranties of merchantability or fitness for a particular purpose. Any implied warranties that may be imposed by law are limited to the terms of this limited warranty. This warranty statement supersedes all previous warranties.



Crestron Electronics, Inc.
15 Volvo Drive Rockleigh, NJ 07647
Tel: 888.CRESTRON
Fax: 201.767.7576
www.crestron.com



**Operations Guide – DOC. 7051D
(2028552)**

08.14

Specifications subject to
change without notice.