

Crestron Flex Tabletop Medium Room Video Conference System for Microsoft Teams® Rooms

The UC-M50-T Crestron Flex tabletop conferencing system provides a medium room video conference solution for use with Microsoft Teams® Rooms software. It supports single or dual video displays and features a Crestron Flex tabletop conference device, UC bracket assembly, and an collaboration camera.

Minimum Requirements:

- A video display (not included) connected to the UC Engine. A second display is optional.
- A Microsoft Teams Rooms provisioned account (not included)



In the Box

Tabletop Conference Device

- 1 Tabletop Conference Device, Microsoft Teams video (6510716)
- 1 Cable, CAT5e, RJ-45 - RJ-45, 12 ft (3.7 m) (2033988)
- 1 Cable Retention Plate (2047908)
- 3 Tie Wrap (2047935)

UC Bracket Assembly

- 1 UC Bracket Assembly with UC Engine and HDMI® content ingest (UC-BRKT-200-S-T-ASSY, 6512689)
- 2 Anchor, Drywall, Plastic, 3/8 in. x 1/2 in. (9.5 mm x 12.7 mm) (2052565)
- 1 Key, Anchor (4529654)
- 2 Screw, 8-AB x 1-1/2 in. (38.1 mm), Pan Head, Combo (2052567)
- 4 Tie Wrap (2047935)

Additional Items

- 1 Collaboration camera (6510482)
- 1 Camera wall mount kit (6510998)
- 1 Cable, CAT6a, RJ-45 - RJ-45, 20 ft (6.1 m) (6507640)
- 1 Cable, CAT5e, RJ-45 - RJ-45, 7 ft (2.1 m) (6509924)
- 1 Cable, DisplayPort™ to HDMI, 6 ft (1.8 m) (6508282)
- 1 Cable, HDMI, 20 ft (6.1 m) (6503567)
- 1 Cable, HDMI, 6 ft (1.8 m) (6503565)
- 1 Cable, USB 2.0, A - Micro-B, 6 ft (1.8 m) (6510947)
- 1 Cable, USB 3.0, Right angle USB-C® to A, 6 ft (1.8 m) (6511591)
- 1 Cable, USB Extension, USB Type A Male-to-Female, 15 ft (4.6 m) (6508260)
- 1 Power supply (6500187)

Crestron Flex Tabletop Medium Room Video Conference System for Microsoft Teams® Rooms



Mount Devices

Mount the UC Bracket Assembly

Mount the UC Bracket Assembly to VESA® compliant display devices, a wall, or other building structure. Anchors and screws are supplied for installation on walls 3/8 in. (9.5 mm) to 3/4 in. (19 mm) thickness.

CAUTION: Preinstalled screws may protrude from the back of the UC Bracket Assembly. Exercise caution when handling the UC Bracket Assembly to avoid scratching or damaging surfaces.

NOTE: The integrated cable tie wraps are reusable. Avoid damaging the cable tie wraps.

Mount the Camera

Mount the included camera according to the [UC-CAM-WMK Quick Start](#) (Doc. 8257).



Install the Cable Retention Plate

The included cable retention plate provides tie-down points for cables that connect to the Crestron® conference device.

Remove the adhesive backing from the cable retention plate and install the plate on the underside of the conference device as shown in the following diagram. Ensure the cable retention plate is firmly attached before securing cables.

CAUTION: When turning over the device, place the device on a soft surface to avoid damage.

NOTE: If a swivel mount kit ([CCS-UCA-SMK](#)) is to be used, use the cable retention bracket included with the swivel mount kit as described in the [CCS-UCA-SMK DO Guide](#) (Doc. 7882).

Install cable retention plate here

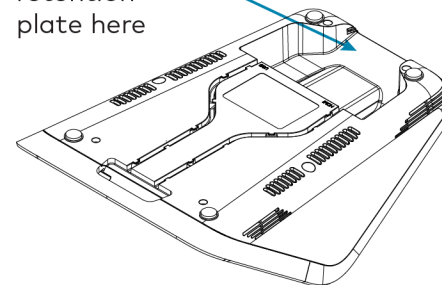

Cable retention plate installed

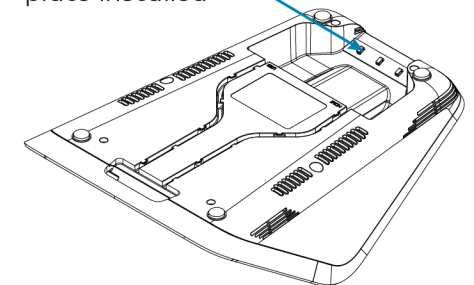

Crestron Flex Tabletop Medium Room Video Conference System for Microsoft Teams® Rooms



Connect

Identify the UC Bracket Assembly

The UC Bracket Assembly is available in two models. Identify the model included with your Crestron Flex system. Tap or click the corresponding image below to navigate to the appropriate connection instructions.

UC Bracket Assembly with HD-CONV-USB-200

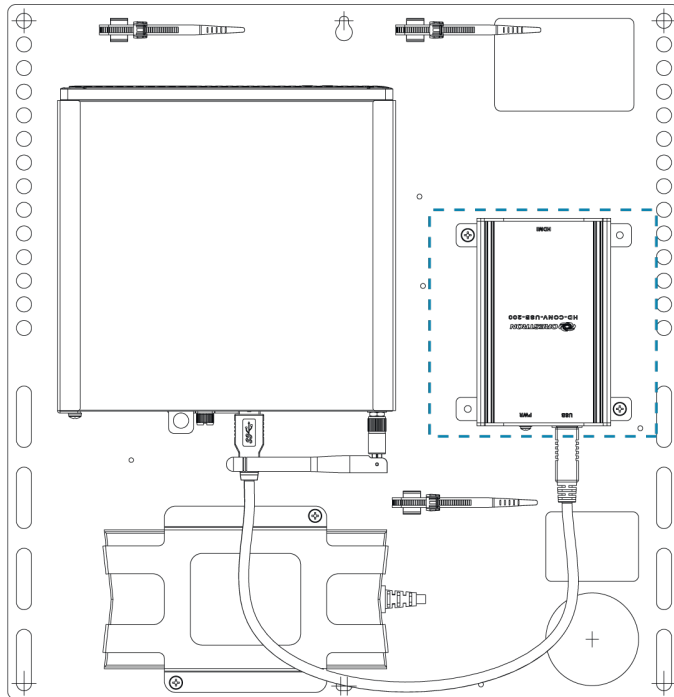

UC Bracket Assembly with HD-CONV-USB-300

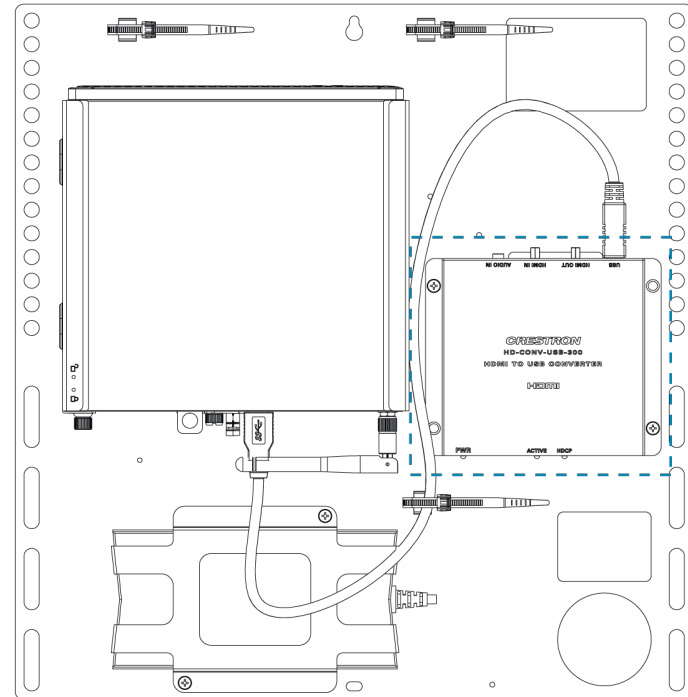

Crestron Flex Tabletop Medium Room Video Conference System for Microsoft Teams® Rooms

System Overview

For UC Bracket Assembly with HD-CONV-USB-200

When connections are complete, the system appears as shown below. Refer to [Make Connections](#) for detailed connection instructions.

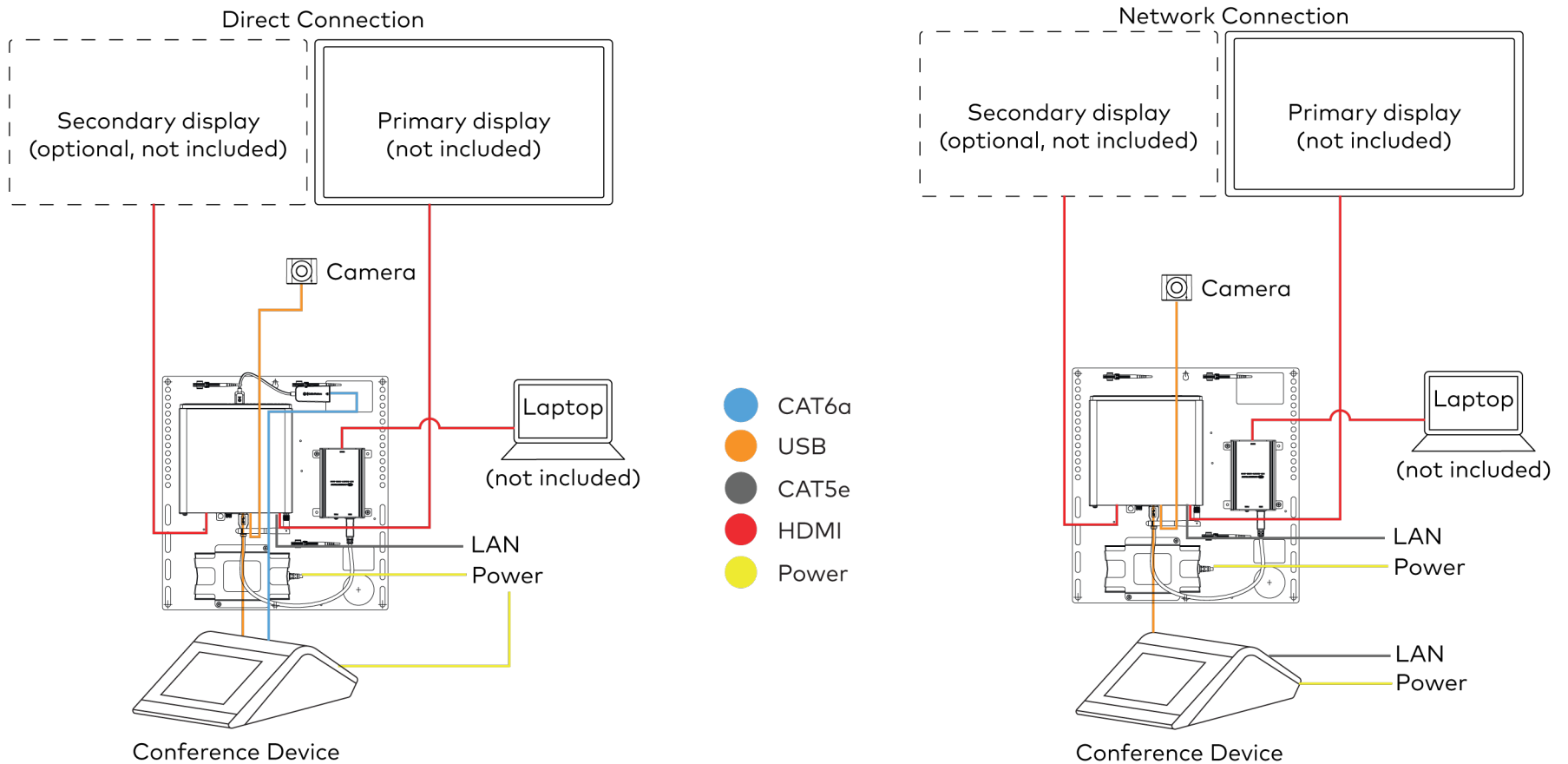

Crestron Flex Tabletop Medium Room Video Conference System for Microsoft Teams® Rooms

For UC Bracket Assembly with HD-CONV-USB-300

When connections are complete, the system appears as shown below. Refer to [Make Connections](#) for detailed connection instructions.

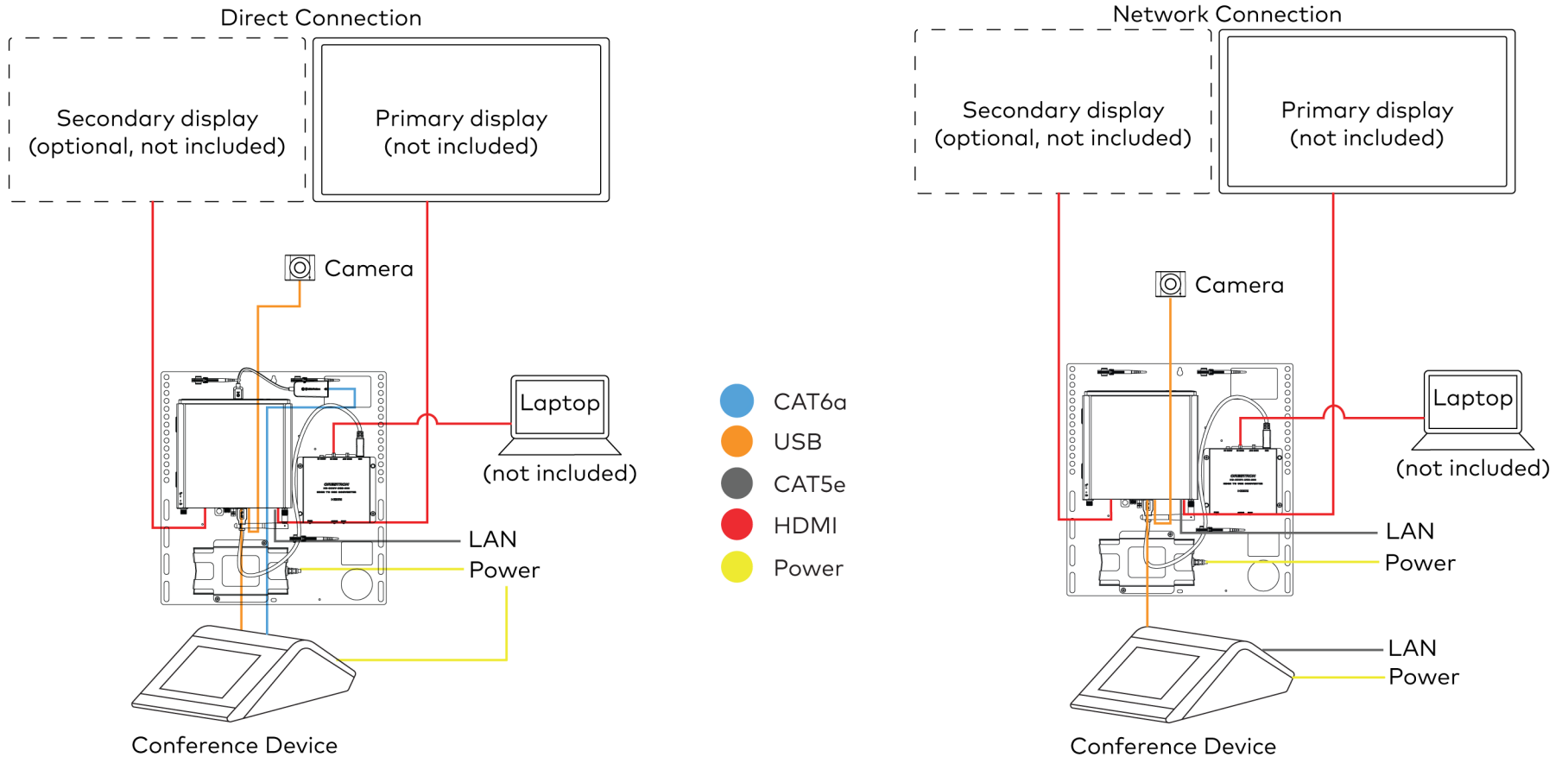

Crestron Flex Tabletop Medium Room Video Conference System for Microsoft Teams® Rooms

Make Connections

NOTE: For reference, the UC Bracket Assembly is shown with the HD-CONV-USB-200 in the following connection diagrams. Unless otherwise indicated in this guide, the connections remain the same for the UC Bracket Assembly with HD-CONV-USB-200 and HD-CONV-USB-300.

1. Make UC Engine connections as shown in the following illustrations. The conference device can communicate with the UC Engine over a direct connection or a network connection. Select one of the connection types as described below.
 - Make a direct connection for simple installation and setup. Only use the direct connect adapter to connect the conference device to the UC Engine. Do not use the direct connect adapter to connect the UC Engine to the network.

Direct Connection

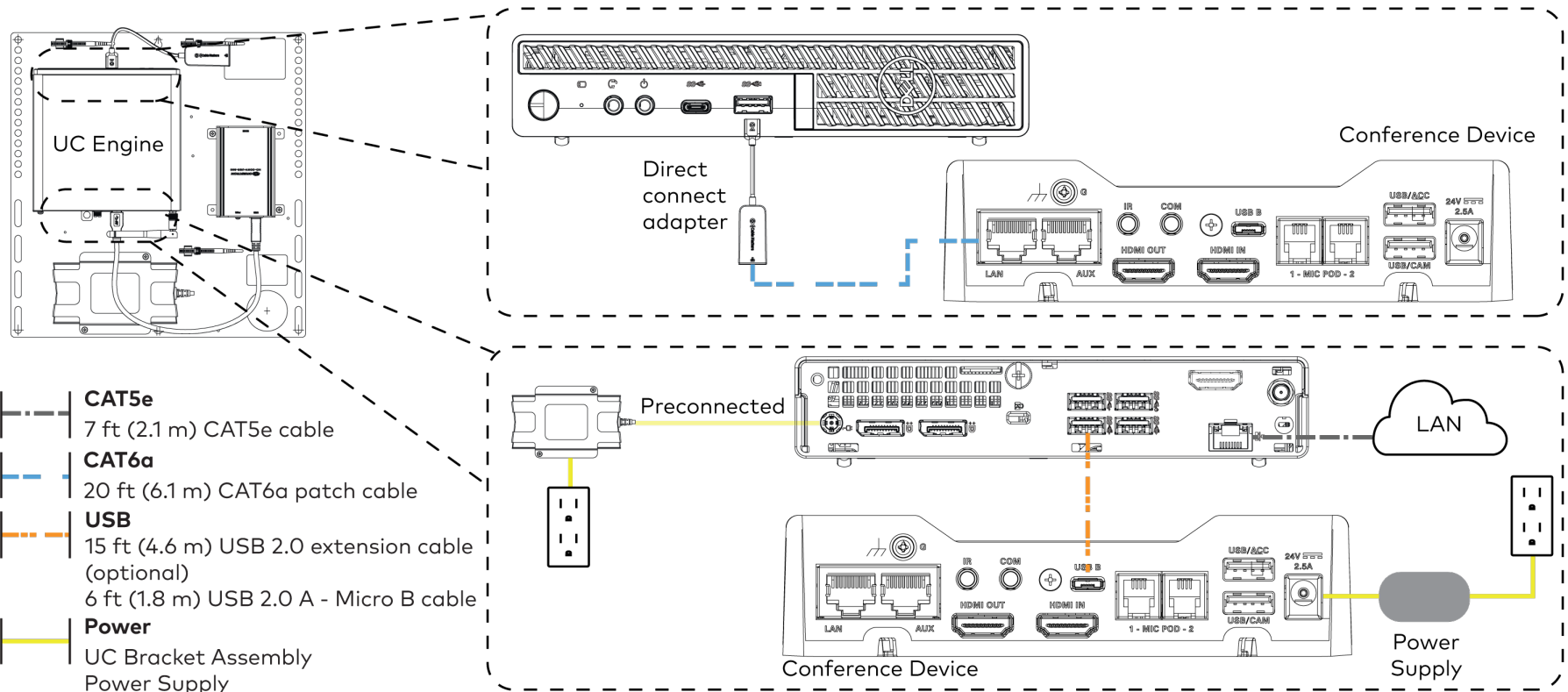

Crestron Flex Tabletop Medium Room Video Conference System for Microsoft Teams® Rooms

- Make a network connection if the system is to be managed by the XiO Cloud® service.

NOTE: When a network connection is used, disconnect the direct connect adapter from the UC Engine.

Network Connection

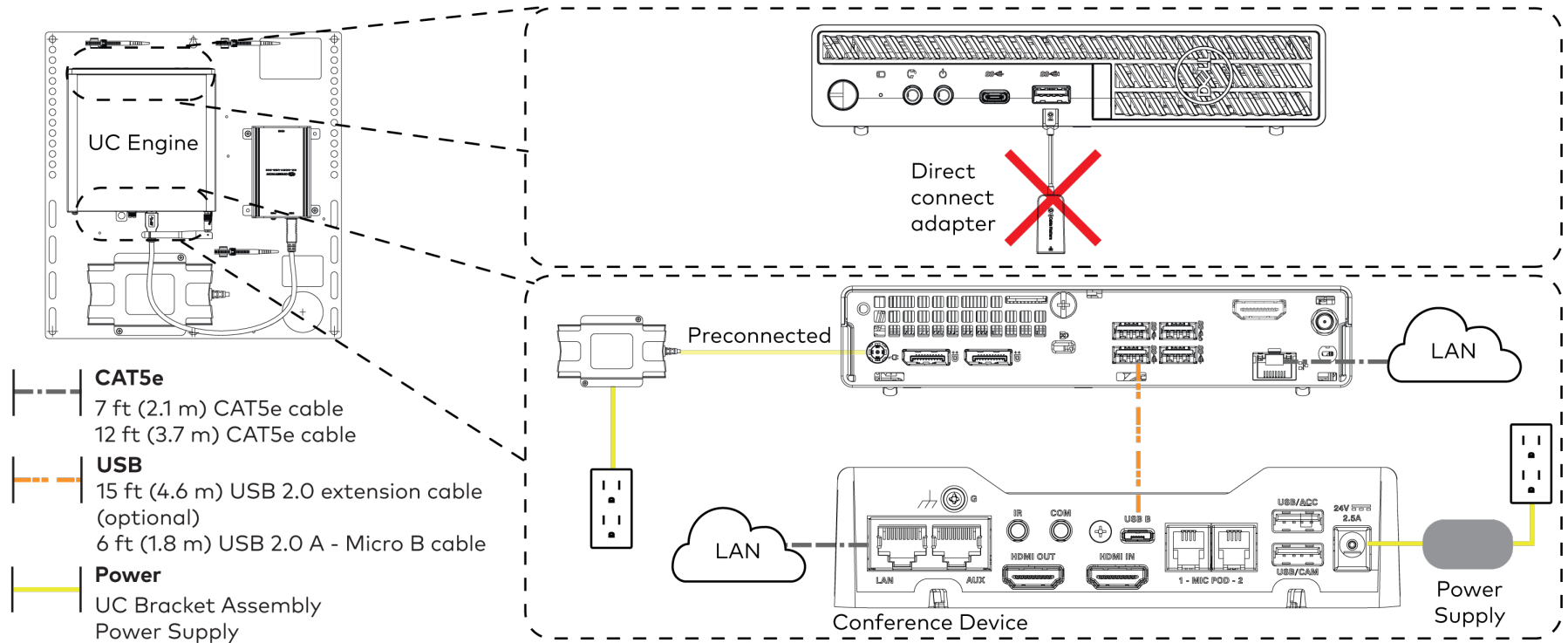

Crestron Flex Tabletop Medium Room Video Conference System for Microsoft Teams® Rooms

2. Connect displays to the UC Engine.

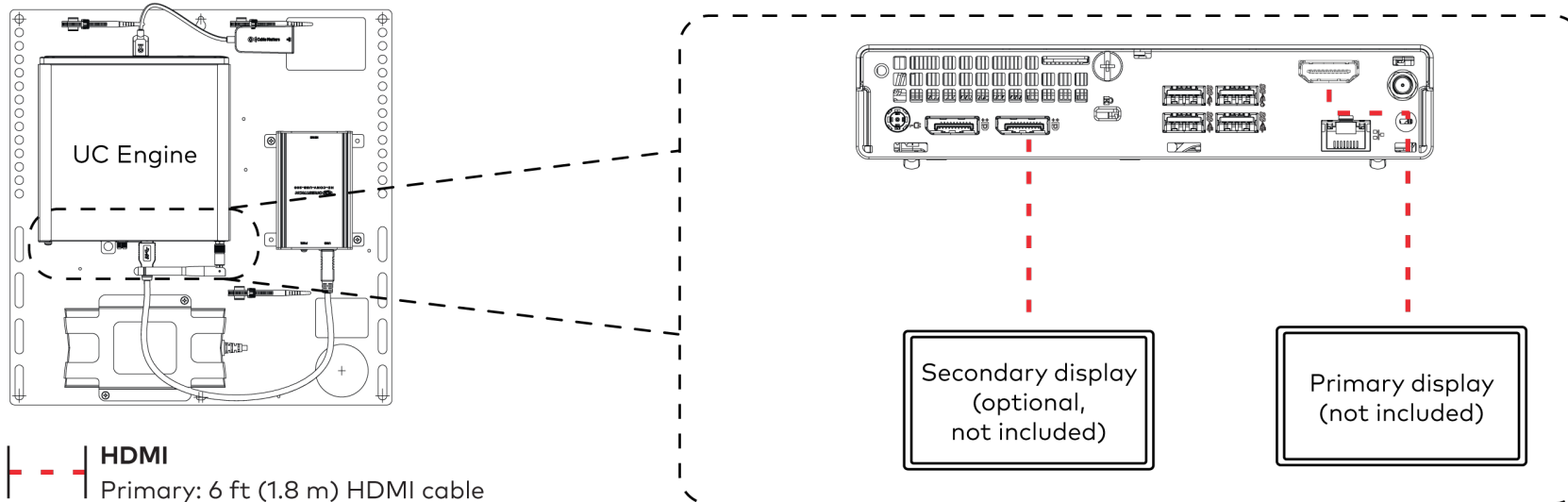

HDMI
Primary: 6 ft (1.8 m) HDMI cable
Secondary: 6 ft (1.8 m) DisplayPort to HDMI cable

Crestron Flex Tabletop Medium Room Video Conference System for Microsoft Teams® Rooms

3. Connect the camera to the UC Engine as shown in the image below. Do not connect the camera to any of the other USB ports.

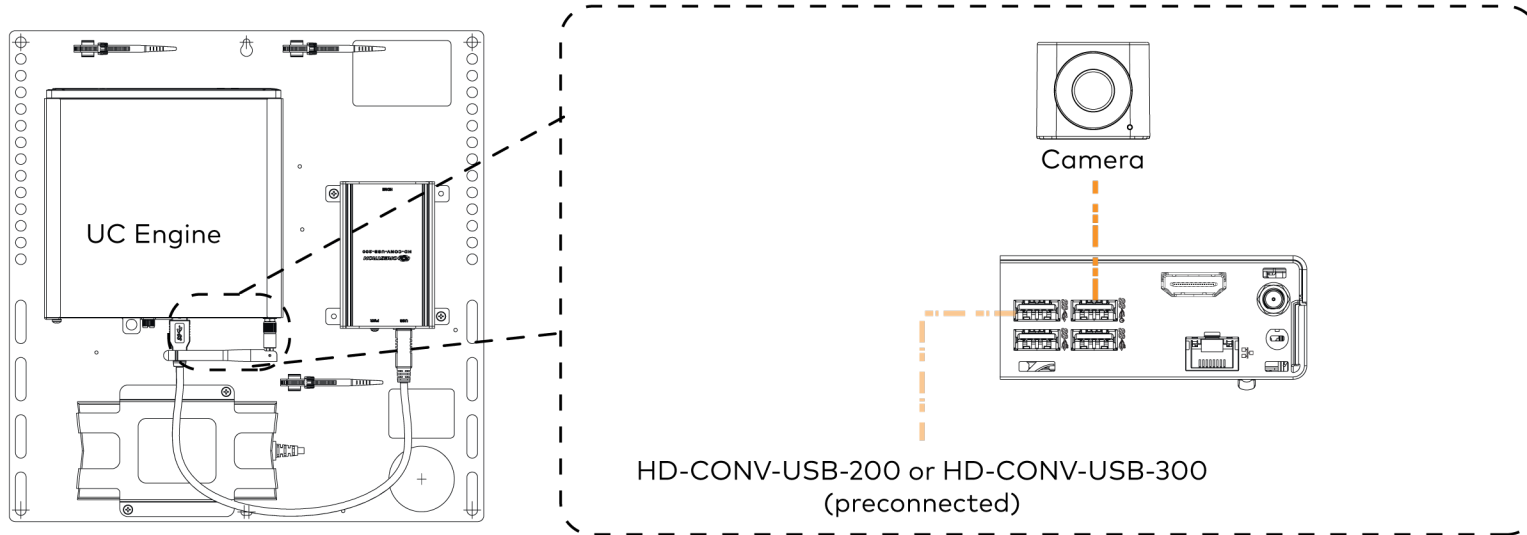

 **USB**
6 ft (1.8 m) USB 3.0, right angle USB-C to A

Crestron Flex Tabletop Medium Room Video Conference System for Microsoft Teams® Rooms

4. Connect a laptop to the HD-CONV-USB-200 or HD-CONV-USB-300.

UC Bracket Assembly with HD-CONV-USB-200

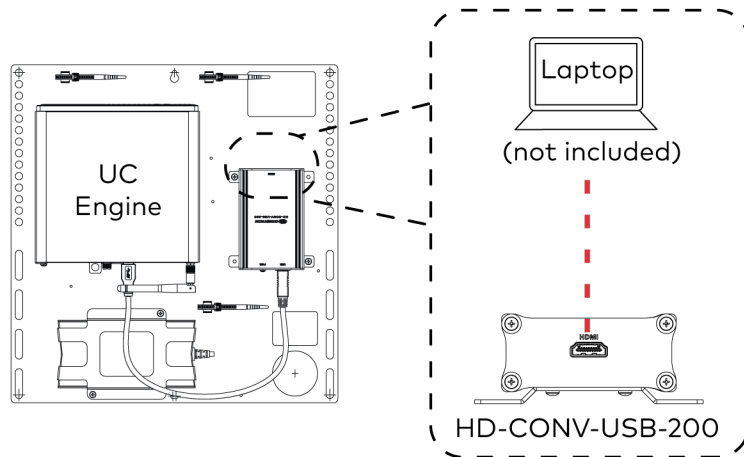

UC Bracket Assembly with HD-CONV-USB-300

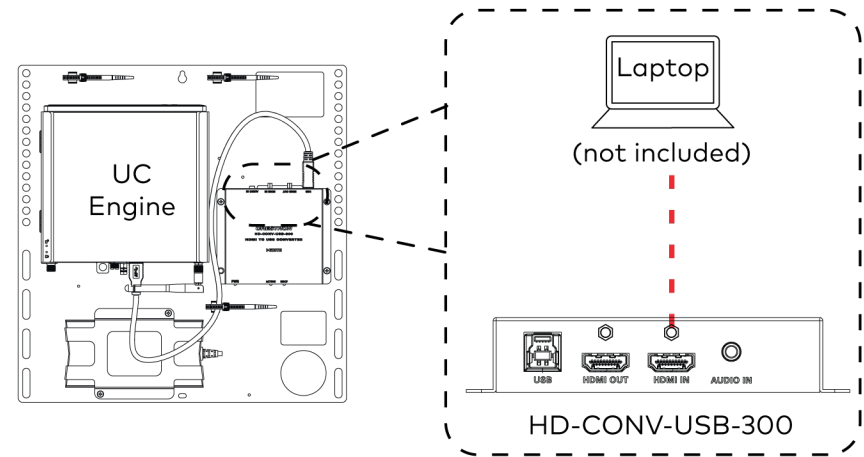

or

 **HDMI**
20 ft (6.1 m) HDMI cable

5. Bundle the cables to the bracket assembly with the integrated cable tie wraps. The cable tie wraps are reusable.

Crestron Flex Tabletop Medium Room Video Conference System for Microsoft Teams® Rooms



Bundle Cables

Bundle the cables together and use a provided tie wrap to secure the bundle to one of the positions on the cable retention plate at the rear of the device. Avoid bundling power and data cables together.

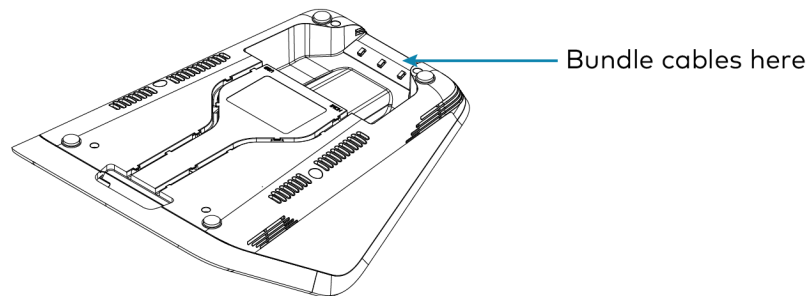

Configure

Apply Power

Press the power button on the bottom of the UC Engine and apply power to all of the other devices in the system. The conference device will display its IP address.

Configure the Conference Device

NOTE: If a Direct Connection was made between the conference device and the UC Engine, skip to [Configure the System](#).

1. On a computer, open a web browser to the IP address displayed on the conference device.

NOTES:

- The device and computer must be on the same network switch and VLAN.
- A login with administrative rights for the device is required.

2. Log in to the device and navigate to **DEVICE > Applications**.
3. Enter the following information in the appropriate fields:
 - **Teams Video PC Address:** Enter the IP address or hostname of the UC Engine.

NOTE: The hostname is printed on a label affixed to the UC Engine.

- **Teams Video PC Port:** By default, port number 49500 is used. If a different port number has been configured on the UC Engine, enter that port number instead.
 - **Teams Video Username:** Enter the login username for the UC Engine. (The default username is "admin".)
 - **Teams Video Password:** Enter the login password for the UC Engine. (The default password is "sfb".)
4. Click **Save Changes**.

For more information, refer to the [CCS-UC-1 Product Manual](#) (Doc. 7844).

Configure the System

Use the conference device and your Microsoft Teams credentials to configure the UC Engine. For detailed information on deploying Microsoft Teams Rooms, refer to the [Microsoft Teams Rooms](#) documentation.

Crestron Flex Tabletop Medium Room Video Conference System for Microsoft Teams® Rooms



Visit the Product Page

Scan the QR code to visit the product page.

UC-M50-T



www.crestron.com/model/6511604

Additional Information

Original Instructions

The U.S. English version of this document is the original instructions. All other languages are a translation of the original instructions.

Crestron product development software is licensed to Crestron dealers and Crestron Service Providers (CSPs) under a limited nonexclusive, nontransferable Software Development Tools License Agreement. Crestron product operating system software is licensed to Crestron dealers, CSPs, and end-users under a separate End-User License Agreement. Both of these Agreements can be found on the Crestron website at www.crestron.com/legal/software_license_agreement.

The product warranty can be found at www.crestron.com/warranty.

The specific patents that cover Crestron products are listed at www.crestron.com/legal/patents.

Certain Crestron products contain open source software. For specific information, visit www.crestron.com/opensource.

Crestron, the Crestron logo, and XiO Cloud are either trademarks or registered trademarks of Crestron Electronics, Inc. in the United States and/or other countries. HDMI is either a trademark or registered trademark of HDMI Licensing LLC in the United States and/or other countries. Microsoft Teams is either a trademark or registered trademark of Microsoft Corporation in the United States and/or other countries. USB-C is either a trademark or registered trademark of USB Implementers Forum, Inc. in the United States and/or other countries. DisplayPort and VESA are either trademarks or registered trademarks of Video Electronics Standards Association in the United States and/or other countries. Other trademarks, registered trademarks, and trade names may be used in this document to refer to either the entities claiming the marks and names or their products. Crestron disclaims any proprietary interest in the marks and names of others. Crestron is not responsible for errors in typography or photography.

©2023 Crestron Electronics, Inc.

Doc. 9302B

01/12/23