

DM-RMC-200-S/DM-RMC-200-S2 DigitalMedia 8G™ Fiber Receiver and Room Controller

DO Install the Device

The Crestron® DM-RMC-200-S and DM-RMC-200-S2 mount onto a 2-gang electrical box using the included support bracket. The support bracket provides a holder for the included power pack.

Mounting the Device onto an Electrical Box

To mount the device onto an electrical box, do the following:

1. Attach the four included 6-32 x 1-1/4" standoffs to the studs of the included support bracket.

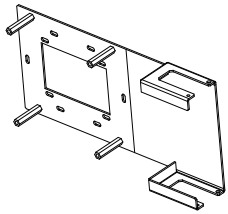

2. Using the four included 6-32 x 3/4" combo truss head screws, attach the included support bracket to the electrical box.

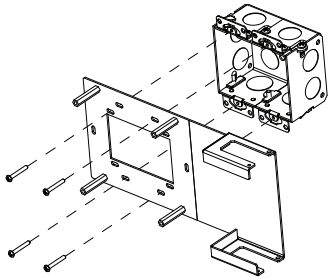

3. Ground the device and then connect the proper cables to the bottom of the unit.

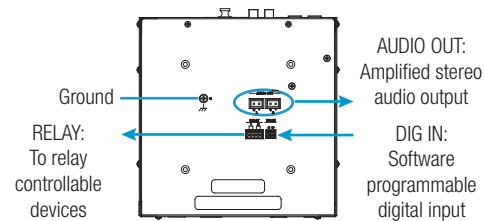

DO Check the Box

QTY	PRODUCT	COLOR	PART NUM.
1	Bracket, Support		2047591
2	Connector, 2-Pin		2003574
4	Connector, 2-Pin		2003582
2	Connector, 4-Pin		2003576
1	Connector, 5-Pin		2003577
1	Power Cord, 5' 10" (1.78 m)		2042043
1	Power Pack, 24 Vdc 2.5 A, 100-240 Vac		2045873
1	Screw, 6-32 x 1/2", Pan Head, Phillips	Black	2007238
4	Screw, 6-32 x 1/4", Pan Head, Phillips	Black	2007215
4	Screw, 6-32 x 3/4", Truss Head, Combo		2009211
4	Standoff, 06-32 x 1-1/4", 1/4" OD, Hex		2007056
2	Tie Wrap, Cable Tie, 15-1/2" x 1"	Black	2013608

4. Using the four included 6-32 x 1/4" Phillips head screws, attach the device to the standoffs.

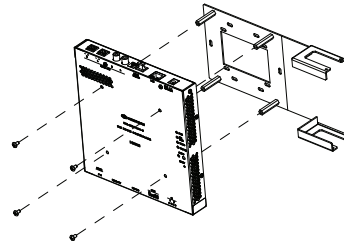

Inserting the Power Pack into the Power Pack Holder

To insert the power pack into the power pack holder, do the following:

1. Slide the power pack into the power pack holder.
2. Using the included 6-32 x 1/2" Phillips pan head screw, thread the screw through either of the two provided screw holes to hold the power pack in place.
3. Bundle the excess cable of the power pack into a loop, and then fasten the bundled cable to the power pack holder by doing the following:
 - a. Insert one of the included tie wraps through one of the tie wrap holes in the power pack holder.
 - b. Wrap the tie wrap around the bundled cable.

- c. Repeat steps 3a and 3b if necessary using the other included tie wrap and the remaining tie wrap hole in the power pack holder.

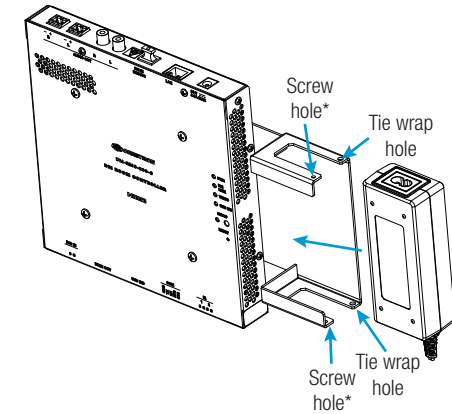

*Use either screw hole for the included 6-32 x 1/2" Phillips pan head screw.

Installation of the power pack in the holder appears as shown below.

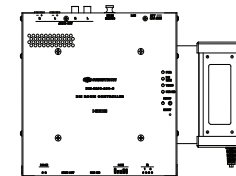

DO Complete the Connections

Make additional connections as appropriate for the application.

DM-RMC-200-S and DM-RMC-200-S2 Front Panel Connections

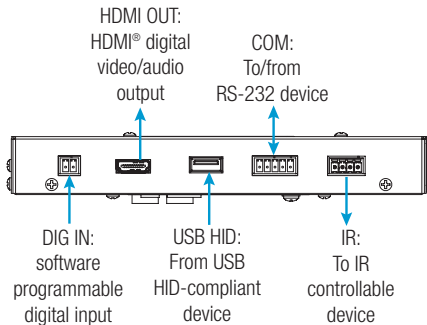

DM-RMC-200-S Rear Panel Connections

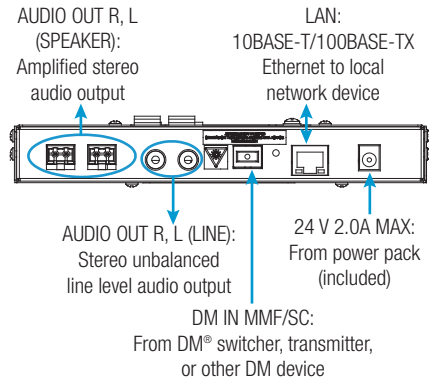

DM-RMC-200-S2 Rear Panel Connections

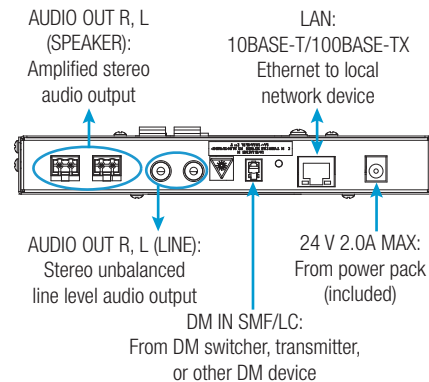

DO Set the IP Address

The configuration of the receiver within the DigitalMedia 8G™ system determines how the IP address of the receiver is set:

- If the receiver connects to a DigitalMedia™ switcher, the receiver is configured by the switcher automatically.
- If the receiver connects to a DigitalMedia 8G fiber transmitter, the receiver uses its own configuration settings. By default, DHCP (Dynamic Host Configuration Protocol) is enabled. If it is desired, assign the default IP address to the receiver by holding down the **SETUP** button while the unit boots up. The default IP address overwrites the current setting. The default IP address of the DM-RMC-200-S and DM-RMC-200-S2 is 192.168.1.248. To manually set a different IP address, use Crestron Toolbox™ application.

DO Learn More

Visit the website for additional information and the latest firmware updates. To learn more about this product, use a QR reader application on your mobile device to scan the QR images.

Crestron Electronics

15 Volvo Drive, Rockleigh, NJ 07647
888.CRESTRON | www.crestron.com

DM-RMC-200-S



DM-RMC-200-S2



As of the date of manufacture, the products have been tested and found to comply with specifications for CE marking.



This product is Listed to applicable UL Standards and requirements by Underwriters Laboratories Inc.
Ce produit est homologué selon les normes et les exigences UL applicables par Underwriters Laboratories Inc.

Federal Communications Commission (FCC) Compliance Statement

This device complies with part 15 of the FCC Rules. Operation is subject to the following two conditions:

(1) This device may not cause harmful interference, and (2) this device must accept any interference received, including interference that may cause undesired operation.

CAUTION: Changes or modifications not expressly approved by the manufacturer responsible for compliance could void the user's authority to operate the equipment.

NOTE: This equipment has been tested and found to comply with the limits for a Class A digital device, pursuant to part 15 of the FCC Rules. These limits are designed to provide reasonable protection against harmful interference when the equipment is operated in a commercial environment. This equipment generates, uses, and can radiate radio frequency energy and, if not installed and used in accordance with the instruction manual, may cause harmful interference to radio communications. Operation of this equipment in a residential area is likely to cause harmful interference in which case the user will be required to correct the interference at his own expense.

Industry Canada (IC) Compliance Statement

CAN ICES-3(A)/NMB-3(A)



The products are class 1 laser products. They comply with safety regulations of IEC-60825-1, FDA 21 CFR 1040.11 and FDA 21 CFR 1040.10.

WARNING: Visible and invisible laser radiation when open. Avoid direct exposure to beam.

NOTE: Plug the included dust cap into the optical transceiver when the fiber optic cable is unplugged.

WARNING: These are Class A products. In a domestic environment these products may cause radio interference in which case the user may be required to take adequate measures.

The specific patents that cover Crestron products are listed at patents.crestron.com.

The product warranty can be found at www.crestron.com/warranty.

Certain Crestron products contain open source software. For specific information, please visit www.crestron.com/opensource.

Crestron, the Crestron logo, Crestron Toolbox, DigitalMedia, DigitalMedia 8G, and DM are either trademarks or registered trademarks of Crestron Electronics, Inc. in the United States and/or other countries. HDMI and the HDMI logo are either trademarks or registered trademarks of HDMI Licensing LLC in the United States and/or other countries. UL and the UL logo are either trademarks or registered trademarks of Underwriters Laboratories, Inc. in the United States and/or other countries. Other trademarks, registered trademarks, and trade names may be used in this document to refer to either the entities claiming the marks and names or their products. Crestron disclaims any proprietary interest in the marks and names of others. Crestron is not responsible for errors in typography or photography.

This document was written by the Technical Publications department at Crestron.

©2016 Crestron Electronics, Inc.