

Crestron **STX-1700C**
2-Way RF Wireless Touchpanel
Operations Guide



This document was prepared and written by the Technical Documentation department at:



Crestron Electronics, Inc.
15 Volvo Drive
Rockleigh, NJ 07647
1-888-CRESTRON

Contents

2-Way RF Wireless Touchpanel: STX-1700C	1
Introduction	1
Functions and Features	1
Roaming Feature	2
Specifications	3
Physical Description	4
Industry Compliance	6
Setup	6
Applying Power	6
Identity Codes	7
Configuring the Touchpanel	8
General Use and Safety	12
Recommended Touchpanel Cleaning	12
Programming Software	12
Earliest Version Software Requirements for the PC	12
Programming with the Crestron SystemBuilder	13
Programming with SIMPL Windows	13
Programming with VT Pro-e	18
Optional Pushbuttons	18
Reserved Join Numbers	18
Uploading and Upgrading	19
Communication Settings	20
Uploading a VT Pro-e Project	24
Firmware Upgrades	25
Problem Solving	27
Troubleshooting	27
Out of Range Feature	28
Further Inquiries	29
Future Updates	29
Appendix A: Optimum RF Reception Guidelines	30
Minimize Interference	30
Gateway Placement	30
Antenna Orientation	30
Appendix B: Installation of Optional Pushbuttons	32
Software License Agreement	33
Return and Warranty Policies	35
Merchandise Returns / Repair Service	35
CRESTRON Limited Warranty	35

2-Way RF Wireless Touchpanel: STX-1700C

Introduction

Functions and Features

The STX-1700C is a two-way wireless radio frequency (RF) compact color touchpanel that provides a user interface to a Crestron® remote control system (herein referred to as the Cresnet® system). The touchpanel is a handheld, transceiver that communicates through Crestron's gateway/transceiver, the STRFGWX (sold separately), to the Cresnet system. The two-way communications provide the control of third party and Cresnet devices and provide dynamic on-screen feedback for real-time confirmation of commands. Up to 15 touchpanels can communicate with one STRFGWX. RF signals can travel from a minimum of three feet up to a maximum of 50 feet indoors (150 feet outdoors). Additional range can be obtained (for roaming) by using multiple STRFGWX gateways (sold separately) distributed throughout any particular area or installation. The location and the antenna position of the STRFGWX are important factors in the RF reception/transmission. The range of the touchpanel is also dependent on its placement and the construction of the building in which it is used. The touchpanel is also available in an international version, the STXI-1700C.

Functional Summary

- 5.7" (14.48 cm) active color matrix display
- 320 x 240 screen resolution
- 63MIPs ColdFire processor running Crestron Isys® generation firmware
- 16-bit non-palette graphics
- 64,000-color Crestron Isys engine
- 4 MB of Flash (approx. 3MB for user display lists)
- 8 MB of SDRAM (Synchronous Dynamic RAM) for panel firmware
- Long-life NiMH battery
 - Fast charging
 - No battery memory
- Compatible with existing STRFGWX RF gateway
- Roaming capability with additional RF Gateways

NOTE: The STX-1700C is supplied with an optional bezel, two 5-button switch actuators, and ten black pushbuttons (blank), five for each side of the LCD screen. You can use these buttons to access any frequently used commands. Refer to

“Appendix B: Installation of Optional Pushbuttons” for instructions to install the optional switches, buttons, and bezel.

NOTE: Two options, 1700C-BTNB (black buttons) or 1700C-BTNS (silver buttons) can be purchased to provide custom engraved buttons for your touchpanel. Contact Crestron customer support for more information.

Included with the STX-1700C are a Crestron High Performance Rechargeable Battery Pack (ST-BTPN) and a Docking Station (ST-DSN) that docks the touchpanel and/or recharges the ST-BTPN. An external power pack (PW-1215 for domestic use or PWI-1215 for international use) is also provided to power the touchpanel. Refer to the latest revisions of the documentation supplied with these items for descriptions and details.

Roaming Feature

This feature allows an STX-1700C to extend its range from room to room by using multiple STRFGWX RF gateways. For proper communication, the RF Channel (refer to “Cresnet Interface Menu” on page 9) must be the same for the touchpanel with respect to all gateways in the system. For information on modifying a SIMPL Windows program for roaming, refer to page 17. For information on optimum RF reception, refer to “Appendix A: Optimum RF Reception Guidelines” on page 30.

NOTE: Minimum distance between multiple gateways for roaming is three feet; the maximum is 80 feet. Crestron recommends placing gateways 60 feet apart for optimum roaming.

Specifications

The table below provides a summary of specifications for the STX-1700C.

Specifications of the STX-1700C Touchpanel

SPECIFICATION	DETAILS
Power Options ST-BTPN	Rechargeable NiMH battery pack (included) 4100 mAh capacity after full charge. (Operating time depends on usage.) ¹
AC: Domestic External Adapter	12VDC, 1.5A, 120VAC Input (included) (P/N PW-1215 or equivalent)
AC: International External Adapter	12VDC, 1.5A, 230VAC Input (included with international version touchpanel) (P/N PWI-1215 or equivalent)
ST-DSN	Docking Station/charger with external power pack (included)
Default Net ID	03
Default RF ID/RF Channel	1/0
Default Timeouts	10 minute for standby 30 minutes for power down
Signal Join Maximums	999 (digital), 256 (analog), 127 (serial)
Control System Update Files ^{2, 3, 4} 2-Series Control System CEN/CN-TVAV CNMSX-AV/PRO CNRACKX-DP ST-CP	Version C2-2004.CUZ or later Version 5.10.13V.UPZ or later Version 5.10.11X.UPZ or later Version 5.10.11W.UPZ or later Version 4.02.02S.UPZ or later
Acceptable file extensions ⁵ .vtz .csf	<i>projectname.vtz</i> (compiled file) STX1700C.vx.xxx.x.csf (panel firmware)
STRFGWX firmware	Version 2.4.1 (2843.upg) or later
RF Specifications	2-Way Wireless RF at 418 MHz, approx. 50 ft. indoor and 150 ft. outdoor ranges ⁶
Memory	4 MB flash memory (3 Mbytes available for user programming) 8 MB SDRAM for firmware storage
Touchscreen Dimensions	Height: 3.700 in (9.017 cm) Width: 4.700 in (11.938 cm)
Touchscreen Resolution	320 x 240 pixels
Touchscreen LCD	Active matrix, 64K colors
Touchscreen Illumination	Backlit fluorescent
Touchscreen Composition	Resistive Membrane
Touchscreen Viewing Angles	±65° horizontal, +65°/-40° vertical
Operating Temperature	50° to 113°F (10° to 45°C)
Humidity	10% to 90% RH (non-condensing)
Overall Dimensions	Width: 8.75 in (22.23 cm) Height: 3.85 in (9.78 cm) Depth: 5.51 in (14.00 cm)
Weight ⁷	1.85 lb (0.84 kg)

- Battery life is 180 minutes continuous usage with background lighting at full brightness. Actual operating time depends on usage and settings for background brightness and timeouts.
- The latest versions can be obtained from the Crestron website. Refer to NOTE after last footnote.

3. Crestron 2-Series control systems include the AV2 and PRO2. Consult the latest Crestron Product Catalog for a complete list of 2-Series control systems..
4. CNX update files are required for either CNMSX-AV/PRO or CNRACKX/-DP. Filenames for CNX update files have a UPZ extension and are in one EXE or zipped UPZ file. To avoid program problems, make certain you are using the update file with the correct suffix letter (e.g., S, V, W, X).
5. Extension requires a prefix specific to the touchpanel type. In DETAILS, *projectname* represents the assigned project name, and *vx.xxx.x* represents a version number.
6. Requires Crestron STRFGWX 2-Way RF Gateway/Transceiver.
7. The weight listed is for the touchpanel and does not include the ST-BTPN, ST-DSN or external power pack.

NOTE: Crestron software and any files on the website are for Authorized Crestron dealers and Crestron Authorized Independent Programmers (CAIP) only. New users may be required to register to obtain access to certain areas of the site (including the FTP site).

Physical Description

The touch-sensitive viewing screen is located on the front of the STX-1700C. The electronic hardware is housed in a black and silver molded plastic enclosure, shown below. Connectors to upload touchscreen projects via a personal computer (PC) and to power the unit using the external power pack are located on the left and right sides of the unit, respectively. Refer to illustrations on the next page.

Physical View of STX-1700C

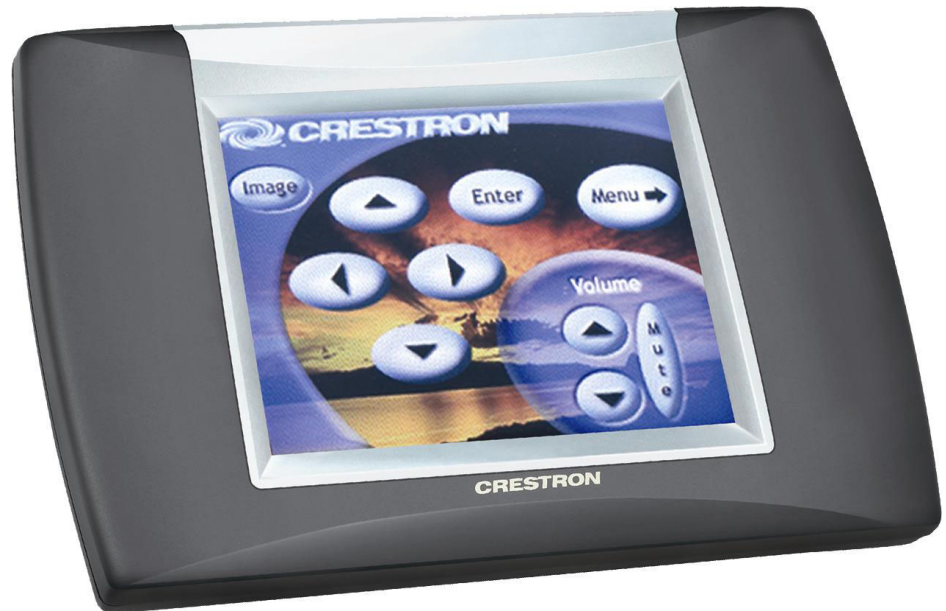

Physical Views (continued)

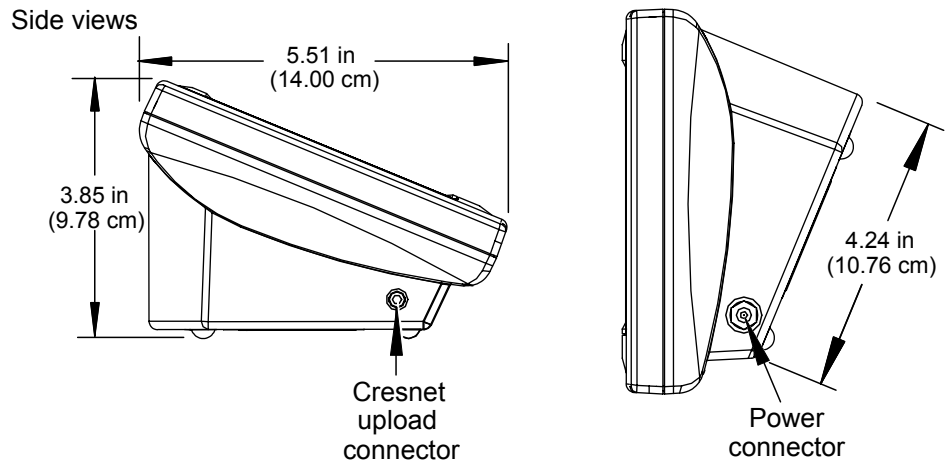
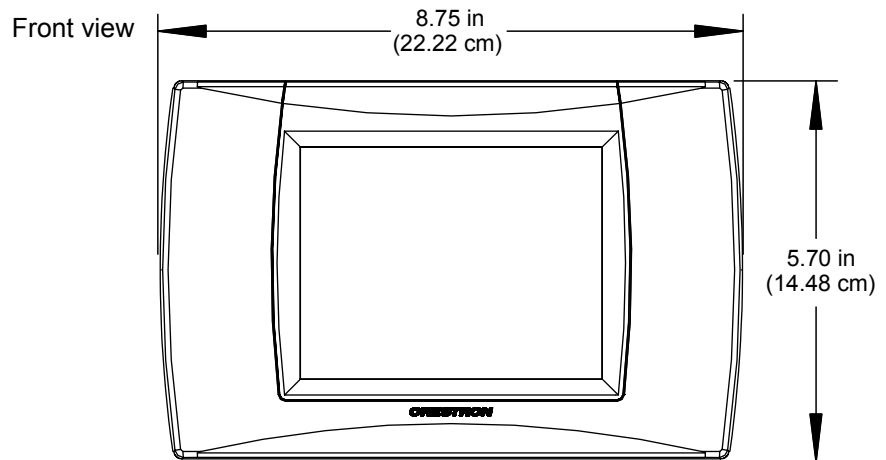
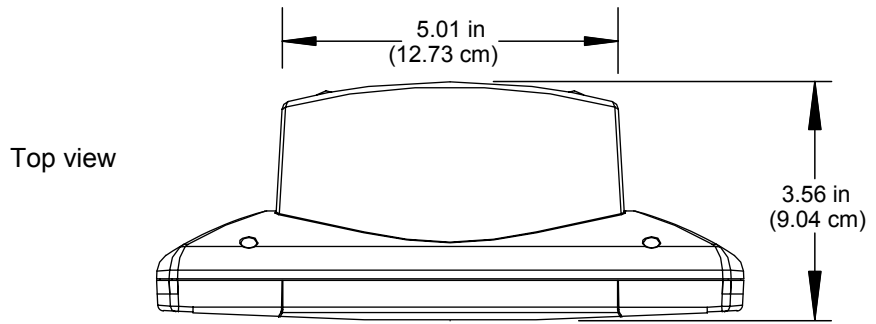

The underside of the unit contains the battery compartment that holds one ST-BTPN. Contacts for the ST-DSN are through the ST-BTPN. Four rubber feet on the underside of the unit are for stability and to prevent slippage on flat surfaces.

Industry Compliance

As of the date of manufacture, this unit has been tested and found to comply with specifications for CE marking and standards per EMC and Radio Communications Compliance Labeling.



NOTE: This device complies with part 15 of the FCC rules. Operation is subject to the following two conditions: (1) this device may not cause harmful interference, and (2) this device must accept any interference received, including interference that may cause undesired operation.

NOTE: This equipment has been tested and found to comply with the limits for a Class B digital device, pursuant to part 15 of the FCC Rules. These limits are designed to provide reasonable protection against harmful interference in a residential installation. The equipment generates, uses and can radiate radio frequency energy and, if not installed and used in accordance with the instructions, may cause harmful interference to radio communications. However, there is no guarantee that interference will not occur in a particular installation. If this equipment does cause harmful interference to radio or television reception, which can be determined by turning the equipment off and on, the user is encouraged to try to correct the interference by one or more of the following measures:

- Reorient or relocate the receiving antenna.
- Increase the separation between the equipment and transceiver.
- Connect the equipment into an outlet on a circuit different from that to which the transceiver is connected.
- Consult the dealer or an experienced radio/TV technician for help.

Setup

Applying Power

The touchpanel can be powered via the ST-BTPN, while docked in the ST-DSN, or via the external power pack. Each of these items has its own Operations Guides which details proper usage. Refer to the table below for the required document number.

STX-1700C Power Source Options

POWER SOURCE OPTION	MODEL	DOCUMENT NUMBER*
Battery Pack**	ST-BTPN	6088
Docking Station	ST-DSN	6095
Domestic External Power Pack, or	PW-1215	5764
International External Power Pack	PWI-1215	5765

* The latest revision may have a revision letter after the document number (i.e., 6088A).

** The battery pack does not “trickle” charge when the external power pack is used to power the touchpanel.

Identity Codes

The STX-1700C touchpanel uses three distinct types of identity (ID) codes for recognition within a Cresnet system: Cresnet identity (Net ID), RF ID, and RF CHANNEL. These codes are assigned to the touchpanel from the Cresnet Interface Menu when the unit is configured. Refer to “Setup Menu” on page 8. For the touchpanel to be identified within the Cresnet system, these assignments must match assignments made in the SIMPL Windows project.

Net ID

Every equipment and user interface within the Cresnet system requires a unique Net ID. These codes are two-digit hexadecimal number from 03 to FE. The Net ID of the unit must match the Net ID specified in the SIMPL Windows program when operating as a wired touchpanel (optional, recommended for testing). The Net ID is used when the touchpanel is wired directly to the control system during uploading a Crestron VisionTools® Pro-e (VT Pro-e) project or upgrading the touchpanel firmware.

RF ID

Every STX-1700C touchpanel communicating with a Cresnet control system via a STRFGWX requires a unique RF ID to secure RF communications. There are 15 useable codes for multiple touchpanel(s) ranging from 1 to F (hexadecimal number). The RF ID of the unit must match the RF ID specified in the SIMPL Windows program. For roaming details, refer to “Modifying a SIMPL Windows Project for Roaming” on page 17.

RF CHANNEL

Each STX-1700C touchpanel communicating to the STRFGWX transceiver must have a RF CHANNEL that matches the RF CHANNEL of the STRFGWX. There are 16 possible RF CHANNELS ranging from 0 to F (hexadecimal number). Having multiple channels available allows for multiple gateways, and therefore many multiple touchpanels, to be used in a given project without signal interference.

NOTE: A single RF CHANNEL may be used by more than one STRFGWX when multiple transceivers are used to expand the roaming capabilities of a touchpanel. For more information, refer to the latest revision of STRFGWX Operations Guide (Doc. 5811) available from the Crestron website (<http://www.crestron.com/manuals>).

Configuring the Touchpanel

MAIN MENU

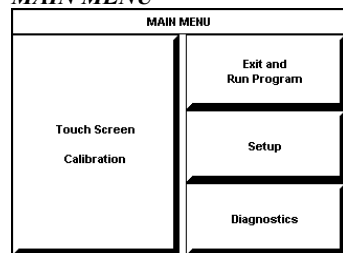

This menu can also be obtained via digital reserved join number, 17242.

To configure the unit, it may be necessary to access a series of setup screens prior to viewing run-time screens that are loaded into the touchpanel for normal operation. The MAIN MENU for configuring the touchpanel appears when a finger is held for about five seconds from the power off state.

Upon entering SETUP MODE, the MAIN MENU, shown to the left, displays four buttons: **Touch Screen Calibration**, **Exit and Run Program**, **Setup**, and **Diagnostics**.

Selecting **Exit and Run Program** verifies that all of the setup information has been saved to EEPROM and displays the main page that has been programmed into the touchpanel. The remaining buttons on the MAIN MENU open other menus, which are discussed in subsequent paragraphs.

Calibration Menu

CALIBRATION MENU

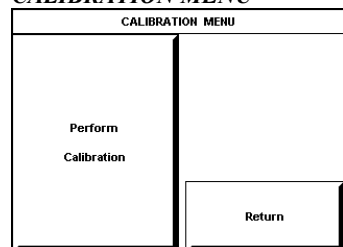

Calibration of the touchscreen is required if the active touch area of a button does not coincide with the button's image. Select the **Touch Screen Calibration** button to display the CALIBRATION MENU, as shown to the left. The CALIBRATION MENU offers the choice to initiate calibration with the **Perform Calibration** button or return to the previous screen with the **Return** button. Choose an option by touching the appropriate button.

If you need to calibrate the touchpanel, the screen displays the message "Touch Upper Left" centered on the panel with a cross hair in the upper left corner. Touch the cross hair to initiate calibration. Another message, "Touch Upper Right", appears with a cross hair in the correct corner. Touch the cross hair. A final message, "Touch Lower Right", appears with a cross hair in the correct corner. Touch the crosshair to finish the calibration and return to the MAIN MENU.

NOTE: When touching each crosshair during calibration, be as accurate as possible. Use the tip of a capped pen or the eraser end of a pencil.

Setup Menu

SETUP MENU

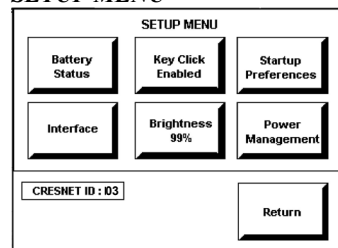

To obtain the SETUP MENU, shown to the left, press the **Setup** button from the MAIN MENU. The SETUP MENU offers a series of buttons, which open additional menus and screens that are detailed in subsequent paragraphs. After setup parameters have been set, select the **Return** button to return to the MAIN MENU.

NOTE: For convenience, the current CRESNET ID setting is displayed in the lower left corner.

NOTE: All touchpanel settings are automatically saved in non-volatile memory.

BATTERY STATUS

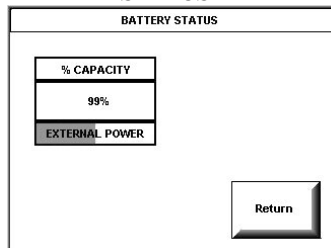

Battery Status

To access the Battery Status screen, shown to the left, press the **Battery Status** button on the SETUP MENU.

This screen indicates the amount of charge (or life) remaining in the battery as a percentage of full capacity, if the battery is installed. An analog bar is provided below the percentage amount as a quick visual reference to the approximate level of charge remaining. The EXTERNAL POWER label appears if external power is applied either through the docking station or via the optional power pack. Note that battery recharging takes place only through the docking station. Touch the **Return** button to display the SETUP MENU.

NOTE: When charging the battery, the battery status screen is not an accurate indicator of battery level. The battery status screen will indicate a full charge (100%) before the docking station indicates that charging is complete (RDY illuminates).

SELECT INTERFACE

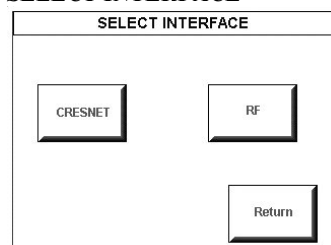

Select Interface

The touchpanel communicates with a control system to activate commands or to display feedback from components within the system. The communication interface must be correctly specified or communication will not occur. To set communication parameters, first select the **Interface** button on the SETUP MENU to display the SELECT INTERFACE screen, shown to the left. Then, select either the **CRESNET** or the **RF** button to display the CRESNET INTERFACE MENU or the RF SETUP screen, respectively. Use these screens to set the Cresnet network identity (CRESNET ID) and the RF ID numbers.

CRESNET INTERFACE MENU

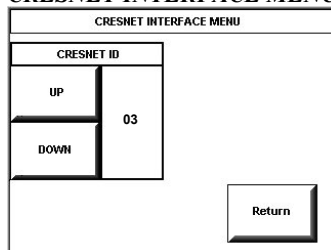

Cresnet Interface Menu

CRESNET ID is a two-digit hexadecimal number that can range from 03 to FE. Note that this number and the Net ID set in the SIMPL Windows program of the Cresnet system must match when operating as a wired touchpanel and for file transfers. Net ID for the STX-1700C is factory set to 03.

The **UP** and **DOWN** buttons increase and decrease the CRESNET ID by one digit (i.e., 03, 04, 05, . . . FE).

Select the **Return** button to return to the SELECT INTERFACE screen.

RF SETUP

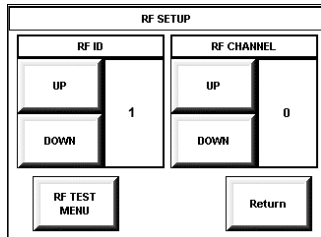

RF Setup

The radio frequency identity number (RF ID) is necessary to secure RF communications such that controls can be activated from the touchpanel. The RF ID consists of a one-digit hexadecimal number. The touchpanel can be set to one of fifteen numbers; “1” is shown as an example in the illustration and is the default. The RF ID setting should match the value assigned to the STX-1700C touchpanel definition in the SIMPL Windows program. Refer to “C2Net-Device Slot in Configuration Manager” on page 14 for information about SIMPL programming/setup for this touchpanel.

The **UP** and **DOWN** buttons increase and decrease the RF ID most significant digit by one, respectively (i.e., 1, 2, 3, . . . F).

The radio frequency channel setting (RF Channel) is necessary for two-way communication between the touchpanel and the STRFGWX. The RF channel consists of a one-digit hexadecimal number. “0” is shown as an example in the illustration on the left and is the default. The down an up arrow buttons increase and

decrease the most significant digit by one, respectively (i.e., 1, 2, 3, ...F). Refer to the latest revision of the STRFGWX Operation Guide (Doc. 5811) for more information on setting up the RF Channel for the RF gateway.

NOTE: The **RF TEST MENU** button should only be used under supervision from a Crestron customer service representative during telephone support.

After the Cresnet ID, RF ID and RF Channel settings have been verified, touch the **Return** button at the bottom of the screen to save settings and display the SELECT INTERFACE screen.

Key Click Setup

KEY CLICK SETUP

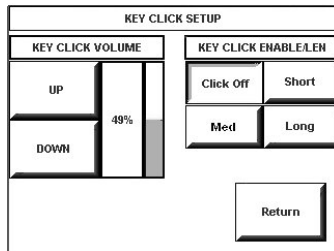

From the SETUP MENU, press the **Key Click Enabled** button to open KEY CLICK SETUP screen. (If the function is currently disabled, the button legend is “**Key Click Disabled.**”) To enable an audible tone (beep) when the touchpanel buttons are pressed, select among the **Short**, **Med**, or **Long** KEY CLICK ENABLE/LEN buttons to set the duration of the tone. The touchpanel responds with a corresponding signal. To disable the feature, select **Click Off**.

Use the KEY CLICK VOLUME **UP** and **DOWN** buttons to increase and decrease the volume of the signal. The area to the right of the buttons shows the relative volume from 0% to 100%, both as a numeric value and, for a quick visual reference, as an analog bar.

Select the **Return** button to return to the SETUP MENU.

SCREEN SETTINGS - BRIGHTNESS

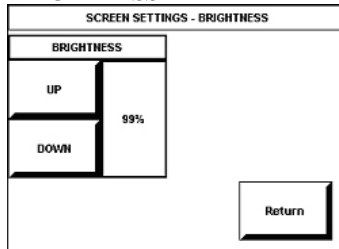

Brightness

From the SETUP MENU, press the **Brightness** button to open the SCREEN SETTINGS – BRIGHTNESS screen. The **UP** and **DOWN** buttons increase and decrease screen brightness, respectively. The area to the right of the buttons shows the relative brightness from 0% to 100%.

Select the **Return** button to return to the SETUP MENU.

STARTUP PREFERENCE

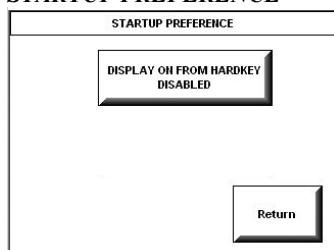

Startup Preference

NOTE: This feature applies only to units with the optional pushbuttons installed. Refer to “Appendix B: Installation of Optional Pushbuttons” for details.

The Startup Preference option allows (when the touchpanel is off or in standby) the display to come on or stay off when a “quick” pushbutton is pressed. From the SETUP MENU, press the **Startup Preference** button to open the STARTUP PREFERENCE screen.

When pressed, the **DISPLAY ON FROM HARDKEY** button toggles between ENABLED and DISABLED. With ENABLED selected, the display comes on when one of the “quick” pushbuttons is pressed. With DISABLED selected, the display stays off when a “quick” pushbutton is pressed (if touchpanel was off, it goes to standby). The default is DISABLED.

Select the **Return** button to return to the SETUP MENU.

POWER MANAGEMENT TIMEOUT SETTINGS

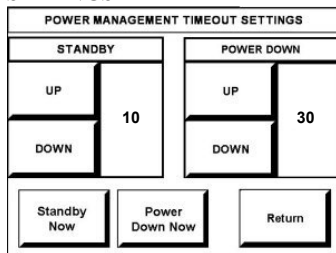

Power Management Timeout Settings

The Power Management feature is intended to conserve energy, and to extend the service life of the battery. From the STARTUP screen, press the **Power Management** button to display the POWER MANAGEMENT TIMEOUT SETTINGS screen. Use the STANDBY and POWER DOWN **UP** and **DOWN** buttons to set the respective timeouts from 0 through 120 minutes, where 0 disables the timeout. Adjusts in one-minute increments from 1 to 10, in ten-minute increments from 20-120.

Use the **Standby Now** and **Power Down Now** buttons to immediately enter the respective mode.

STANDBY timeout turns the display and backlight off when the touchpanel is inactive for the specified time. When the touchpanel is reactivated, the last screen to be displayed reappears. The specified time is displayed in minutes. The default STANDBY timeout is 10 minutes.

POWER DOWN timeout turns off all power when the touchpanel is inactive for the specified time. When the touchpanel is activated, the first page of the project appears. The specified time is displayed in minutes. The default POWER DOWN timeout is 30 minutes. Adjusts in one-minute increments from 1 to 10, in ten-minute increments from 20-120.

NOTE: Power Down Timeout should be set low to maximize battery life. However, Power Down Timeout should be set greater than Standby Timeout. Otherwise, the Standby Timeout is meaningless.

NOTE: When the panel is powered down, it will take about 1.5 seconds to power up and respond to a button press. There is no delay from Standby mode.

NOTE: If the external AC power pack is attached to the touchpanel and plugged into an active AC receptacle or if the touchpanel is resting in the docking station (ST-DSN) and plugged into an active AC receptacle, the panel does not power down when the power down timeout is achieved. Recall that the purpose of this timeout is to maximize battery life. Standby timeout still functions.

Press **Return** to save the settings and return to the SETUP MENU.

DIAGNOSTICS MENU

DIAGNOSTICS MENU

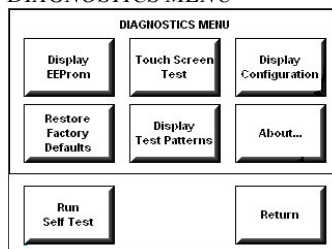

The **Diagnostics** button from the MAIN MENU should only be used under supervision from a Crestron customer service representative during telephone support. Many options available from the DIAGNOSTICS MENU, shown to the left, are numeric in nature and their interpretation is beyond the scope of this manual.

General Use and Safety

WARNING: To avoid shock hazard and possible damage to the unit, do not use touchpanel in rain or expose it to unnecessary moisture.

Recommended Touchpanel Cleaning

Keep the surface of the touchscreen free of dirt, dust, or other materials that could degrade optical properties. Long-term contact with abrasive materials can scratch the surface that may detrimentally affect image quality.

For best cleaning results, use a clean, damp, non-abrasive cloth with any commercially available non-ammonia glass cleaner. Surrounding plastic enclosure may not provide a complete watertight seal. Therefore, apply cleaning solution to the cloth rather than the surface of the touchscreen. Wipe touchscreen clean and avoid ingress of moisture beneath panels.

Programming Software

Have a question or comment about Crestron software?

Answers to frequently asked questions (FAQs) can be viewed in the Online Help section of the Crestron website. To post a question or view questions you have submitted to Crestron's True Blue Support, log in at <http://support.crestron.com>. First-time users will need to establish a user account.

You can create a program that allows you to set up the STX-1700C to operate a Crestron control system using the Crestron programming tools Crestron SystemBuilder™ and SIMPL Windows. These tools are intended for users with different levels of programming knowledge. The flexibility of each tool is proportional to the degree of programming expertise (i.e., the more flexible, the more a programmer needs to know and account for). Of course, one can initiate programming using the easiest method (SystemBuilder) and use advanced techniques that are available from SIMPL Windows to customize the job.

VT Pro-e is a Windows® compatible software package for creating Crestron touchpanel screen designs. Refer to “Programming with VT Pro-e” on page 18 for additional details regarding VT Pro-e.

Earliest Version Software Requirements for the PC

NOTE: Crestron recommends that you use the latest software to take advantage of the most recently released features. The latest software is available from the Crestron website.

The following are recommended software version requirements for the PC:

- SystemBuilder version 1.02 or later. Requires SIMPL Windows and Crestron Engraver. **Requires** SystemBuilder templates 1.01 or later.
- SIMPL Windows version 2.05.22 or later.
Requires SIMPL+ Cross Compiler version 1.1.

- Crestron Database version 16.2.1 or later. Required by SIMPL Windows.
- VisionTools Pro-e version 3.2.1.8 or later. Used for graphical touchscreen design.
- (Optional) Crestron Engraver version 2.3.0.0 (only required if using SystemBuilder or if optional hard buttons and bezel are installed, and 1700C-BTNB or 1700C-BTNS engraveable button kits are purchased).

The easiest method of programming, but does not offer as much flexibility as SIMPL Windows.

Programming with the Crestron SystemBuilder

The Crestron SystemBuilder offers automatic programming for such residential and commercial applications as audio distribution, home theater, video conferencing, and lighting. The interface of this tool guides you through a few basic steps for designating rooms and specifying the control system, touchpanels, devices, and functionality. The Crestron SystemBuilder then programs the system, including all touchpanel projects and control system logic.

Crestron SystemBuilder is fully integrated with Crestron's suite of software development tools, including SIMPL Windows, VT Pro-e, Crestron Engraver, Crestron Database, User IR Database, and User Modules Directory. Crestron SystemBuilder accesses these tools behind the scenes, enabling you to easily create robust systems.

Programming with SIMPL Windows

NOTE: The following assumes that the reader has knowledge of SIMPL Windows. If not, refer to the extensive help information provided with the software.

NOTE: In the following description, the PRO2 control system is used.

NOTE: The STX-1700C can operate as a wired panel when set correctly in the SIMPL program. This is recommended to troubleshoot the program code and to eliminate wireless/RF configuration issues before running the program in wireless mode.

SIMPL Windows is Crestron's software for programming Crestron control systems. It provides a well-designed graphical environment with a number of workspaces (i.e., windows) in which a programmer can select, configure, program, test, and monitor a Crestron control system. SIMPL Windows offers drag and drop functionality in a familiar Windows® environment.

This section describes a sample SIMPL Windows program that includes an STX-1700C.

Configuration Manager is where programmers “build” a Crestron control system by selecting hardware from the *Device Library*. In Configuration Manager, drag the PRO2 from the Control Systems folder of the *Device Library* and drop it in the upper pane of the *System Views*. The PRO2 with its associated communication ports is displayed in the *System Views* upper pane.

PRO2 System View

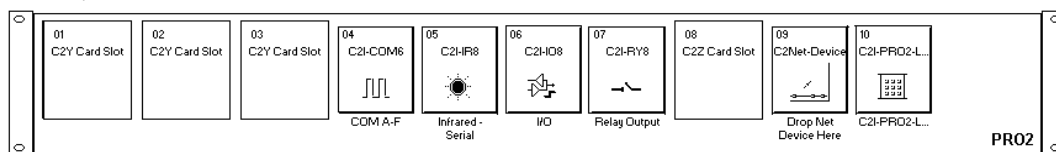

The *System Views* lower pane displays the PRO2 system tree as shown below. This tree can be expanded to display and configure the communications ports.

Expanded PRO2 System Tree

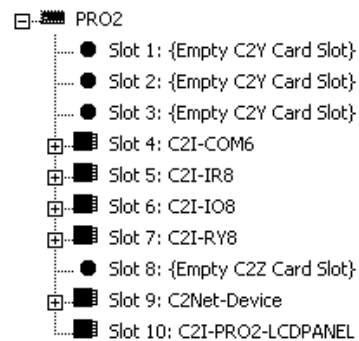

C2Net-Device Slot in Configuration Manager

To incorporate an STX-1700C into the system, a gateway device is required. The C2Net-Device Slot can accept a gateway such as the STRFGWX. Once a gateway is configured in a C2Net-Device Slot, the slot allows Cresnet communication between the touchpanel and the control system.

In Configuration Manager, drag the STRFGWX gateway from the Wireless Receivers (RF) folder of the *Device Library* and drop it in the upper pane of the *System Views*. The *System Views* upper pane displays the STRFGWX device icon below the PRO2 graphic.

Drag the STX-1700C from the Touchpanels (Wireless | Wireless Two-Way) folder of the *Device Library* and drop it on the STRFGWX symbol in *System Views*. The PRO2 system tree displays the STRFGWX gateway in Slot 9, with a default Net ID of 4F. The STRFGWX displays the touchpanel at the touchpanel's default RF ID location, "01," as shown in the graphic below.

C2Net Device, Slot 9

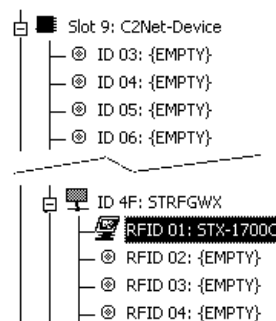

Double-click the STRFGWX icon in the upper pane to open the "Device Settings" window. This window displays STRFGWX device information. Select the Net ID tab to change the gateway Net ID, as shown in the following graphic.

“Device Settings” Window for the STRFGWX

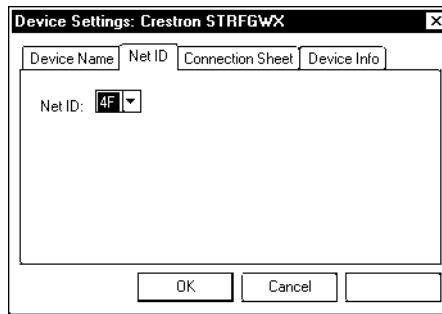

Similarly, expand the system tree in the lower pane and double-click the STX-1700C icon to open the “Device Settings” window for the touchpanel. Select the RF/IR ID tab to change the touchpanel RF ID, as shown below. For more information on setting the RF/IR ID, refer to “RF Setup” screen shown on page 9.

Touchpanel “Device Settings” Window

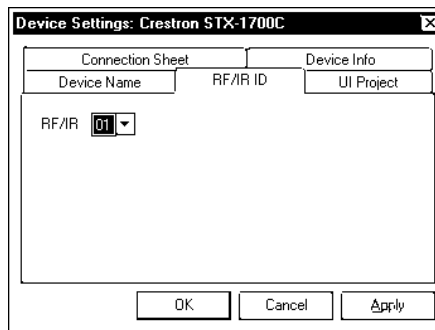

STX-1700 Symbol in Programming Manager

Programming Manager is where programmers “program” a Crestron control system by assigning signals to symbols. The following diagram shows the STX-1700C symbol in the SIMPL Windows’ Programming Manager.

Detail View of the STX-1700C in SIMPL Windows’ Programming Manager

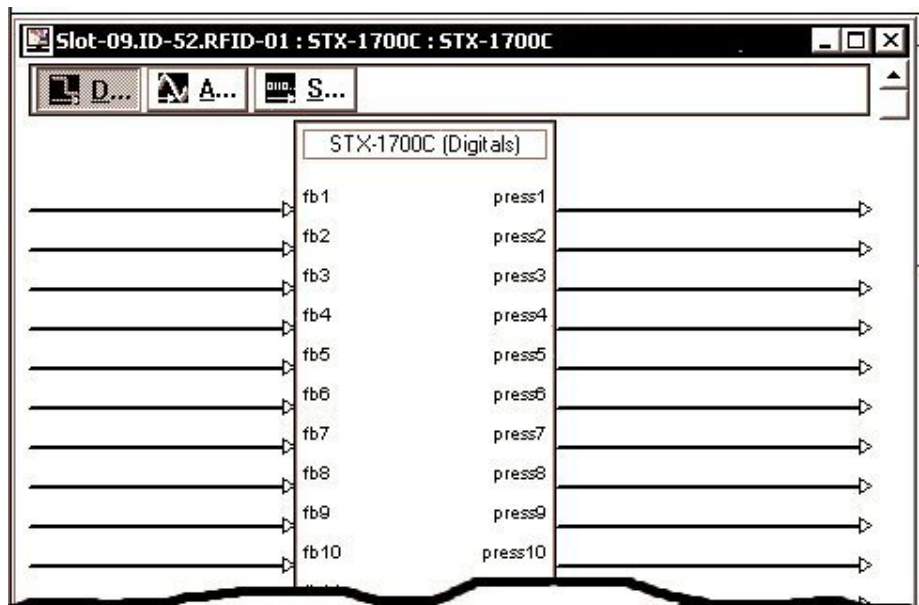

Signal Types

Signals interconnect the various devices and logic symbols that comprise a SIMPL program. Signals can be one of three types: digital, analog, or serial. For any given signal, the signal type is determined by its driving source. That is, if the symbol that drives the signal has an analog output, then, by definition, the signal connected there will be an analog signal.

In SIMPL Windows, the signal types are color-coded as follows:

Digital = Blue

Analog = Red

Serial = Black

Other = Green

NOTE: “Other” signals are a combination of the three basic types (e.g. many symbols accept either analog or serial signals where the combination is shown as a green signal). The signal type is displayed on the Status Bar when the signal is highlighted.

For additional information, refer to Doc. 6120, Crestron SIMPL Windows Symbol Guide. It may be downloaded from the Crestron website.

Digital Signals

A digital signal contains one bit of information and usually takes on one of two values: 1 or 0. These two digits can represent the logical values true and false, and they can be represented in an electronic device by the states on/off or high/low, recognized as two voltage levels. (Other common descriptors are active/inactive.)

Analog Signals

Unlike digital signals, analog signals can vary continuously in value, in the same manner as a parameter such as volume, temperature, or pressure. Analog signals contain 16 bits of information, which means that this type of signal can have values ranging from 0 to 65535 ($2^{16}-1$). This 16-bit property makes analog signals useful for controlling devices that do not have discrete settings, such as volume controllers, pan/tilt head controllers, and lighting dimmers.

Serial Signals

Serial signals are much like analog signals, in that they, too, contain 16 bits of information. However, whereas the value of an analog signal is used directly—to control volume or temperature, for instance—the value of the serial signal is used as a pointer to a location in memory that contains a string of characters. When a serial signal is routed to a symbol, that symbol can identify the signal as serial rather than analog and it will automatically look at the data to which it points.

Thus, serial signals are used to facilitate the transmission of serial data (strings of characters). These signals can be generated by incoming data on a COM port or by a symbol that has a serial output.

STX-1700C Input/Output Signals

The STX-1700C symbol provides up to 999 digital joins, up to 256 analog joins, and up to 127 serial input joins. The programmer selects the signal types by clicking on the appropriate button at the top of the *Symbol Detail* view when programming the panel.

The tables below list functional descriptions for the touchpanel digital outputs and inputs.

Digital Output Signal Descriptions

OUTPUT	DESCRIPTION
press 1 through press 999	Notifies control system of button press (1 – 999). High/1 = press On Low/0 = press Off

Digital Input Signal Descriptions

INPUT	DESCRIPTION
fb 1 through fb 999	Notifies panel of button press (1 – 999).

Analog Output Signal Descriptions

OUTPUT	DESCRIPTION
an_act 1 through an_act 256	Notifies control system of an analog action (1 – 256). Any value from 0 through 65535

Analog Input Signal Descriptions

INPUT	DESCRIPTION
an_fb 1 through an_fb 256	Notifies panel of analog feedback (1 – 256).

Serial Input Signal Descriptions

INPUT	DESCRIPTION
text-o1 through text-o127	Notifies panel of text string (1 – 127). Also called indirect text.

Device Extenders

Device extenders provide additional logic and functionality to a device. The Poll Manager and Sleep/Wake Manager symbols are device extenders for touchpanels. For the STX-1700C in wired mode only, the Poll Manager takes the touchpanel on and off line during polling by the control system. In wireless mode, Sleep/Wake Manager suspends and restores operation of the touchpanel. For additional information about Device Extenders, refer to the latest version of the Crestron SIMPL Windows Symbol Guide (Doc. 6120), or the on-line help included with SIMPL Windows.

Modifying a SIMPL Windows Project for Roaming

To implement roaming in a system that originally had two STX-1700Cs and one gateway, you would need to add a STRFGWX RF gateway to your SIMPL Windows project and add two STX-1700Cs under the new gateway in *System Views*. For simplicity, in this example we assigned the original gateway a Cresnet ID of 03 and the original touchpanels RF IDs of 01 and 02. To extend the range, we will assign the new gateway a Cresnet ID of 04 and add two new touchpanel symbols in the system. These touchpanels will have the same RF IDs (01 and 02) as the original touchpanels mentioned above. Additionally, in *Program View*, you will need to duplicate the logic for each touchpanel communicating with the original gateway and paste it in the touchpanel symbol associated with the added gateway. For example, the logic in the original STX-1700C symbol at RF ID 01 must be copied and pasted

in the new STX-1700C symbol at RF ID 01. The logic in the original STX-1700C symbol at RF ID 02 must be copied and pasted in the new STX-1700C symbol at RF ID 02. To do this for RF ID 01 (in *Program View*), place the arrow cursor on the original touchpanel at RF ID 01. Right click and hold the mouse button to select RF ID 01. Drag and drop this RF ID 01 selection on the new touchpanel at RF ID 01 and release the mouse button (a pulldown menu appears). Select **Copy All Signals/Parameters** from the pulldown menu.

Programming with VT Pro-e

Control screen variations incorporating two- and three-dimensional graphics and text are possible and can be created with VT Pro-e, a design and programming Windows®-based software program. A set of pages, which make up a project, can be designed for each application. Each touchpanel can be organized with the ideal, color-oriented control environment with custom control graphics: icons, two and three-dimensional buttons, and floor plans. The project is uploaded to the touchpanel's flash PROM. The touchpanel uses the project until another is uploaded from the PC. The PC may be disconnected from the control processor except when uploading a project.

For additional software information, refer to the help file provided with the software. The latest version of VT Pro-e can be obtained from the Crestron website.

Optional Pushbuttons

Pushbutton Layout and Join Number Assignment

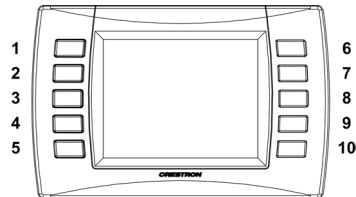

If the optional ten “hard” pushbuttons are installed, you can use these buttons to access any frequently used commands (refer to “Appendix B: Installation of Optional Pushbuttons”). Each button has a permanently fixed digital join number; refer to the illustration shown to the left. The sequence of digital join numbers is (top to bottom) 1 through 5 on the left side and 6 through 10 on the right side.

NOTE: A user may not want the display to come on after a pushbutton is pressed when the unit is off. The Startup Preference option allows the user to select whether the touchpanel's display comes on or stays off after a pushbutton is pressed. For more information, refer to “Startup Preference” on page 10.

NOTE: To program a quick pushbutton to flip a page (change a screen) on the STX-1700C, go to the *Hard Keys* tab of the “Project Properties” window in VT Pro-e. Select a button from the *Button* drop-down list, and then select the desired page from the *Page Flip* drop-down list. When the button is pressed, the page is displayed.

The quick pushbuttons can also be programmed to do a page flip via SIMPL Windows.

Reserved Join Numbers

A reserved join number is a feature of the software that enables a designer to create a button that completes a predetermined function. The tables on the next page provide lists of reserved join numbers available within the VT Pro-e software.

NOTE: Many touchpanel configuration “shortcuts” are available via the software. A button can be created on a page that either calls up the Preferences Menu, adjusts brightness, etc., via reserved join numbers.

Digital Reserved Join Numbers STX-1700C

JOIN NUMBER	FUNCTION	VALUE	DIRECTION ²
17200	Power	Off	I
17216	Brightness	Up	I
17217	Brightness	Down	I
17218	Brightness	High	I
17219	Brightness	Medium (Default)	I
17220	Brightness	Low	I
17230	Standby	On	I/O
17231	Standby Timeout	Up	I
17232	Standby Timeout	Down	I
17233	Power Timeout	Up	I
17234	Power Timeout	Down	I
17242	Setup	N/A	I
17302	Keyclick	On	I/O
17303	Keyclick	Off	I/O
17304	Key Click Volume	Up	I
17305	Key Click Volume	Down	I
17322	Key Click Short	Short (Default)	I
17323	Key Click Medium	Medium	I
17324	Key Click Long	Long	I
17509	Out of Range ¹	N/A	O
17532	Send Update Request	N/A	O

1. Assigning 17509 (Out of Range) to a page, sub page or button activates the page, subpage or button when the STX-1700C goes out of range (is no longer communicating with an STRFGWX).
2. "I" indicates that pressing a button with this join number commands the touchpanel to perform the function. "O" indicates feedback to the display (all actions are local to the touchpanel, no information is transmitted).

Analog Reserved Join Numbers for STX-1700C

JOIN NUMBER	FUNCTION	VALUE	DIRECTION ²
17201	LCD Brightness ¹	1-100%	I/O
17202	Power Timeout ¹	0-120 minutes	I/O
17203	Standby Timeout ¹	0-120 minutes	I/O
17300	Key Click Volume ¹	1-100%	I/O
17507	Battery Level	0-100%	O

- 1 Defaults:
LCD Brightness – 50% Standby Timeout – 10 minutes
Power Timeout – 30 minutes Key Click Volume – 50%
- 2 "I" indicates that pressing a button with this join number commands the touchpanel to perform the function. "O" indicates feedback to the display (all actions are local to the touchpanel, no information is transmitted).

Uploading and Upgrading

NOTE: Crestron recommends that you use the latest software and that each device contains the latest firmware to take advantage of the most recently released features. Please check the Crestron website (<http://www.crestron.com/updates>) for the latest versions of software and firmware. New users are required to register to obtain access to this site.

Assuming a PC is properly connected to the entire system, Crestron programming software allows the programmer to upload programs and projects after their development to the system and network devices. However, there are times when the files for the program and projects are compiled and not uploaded. Instead, compiled files may be distributed from programmers to installers, from Crestron to dealers, etc. Even firmware upgrades are available from the Crestron website as new features are developed after product releases. In those instances, one has the option to upload via the programming software or to upload and upgrade via the Crestron Viewport.

NOTE: The Crestron Viewport utility performs multiple system tasks, primarily via an RS-232 or TCP/IP connection between the control system and a PC. It is used to observe system processes, upload new operating systems and firmware, change system and network parameters, and communicate with network device consoles and touchpanels, among many other tasks. Viewport can also function as a terminal emulator for generic file transfer. All of these functions are accessed through the commands and options in the Viewport menus. Therefore, for its effectiveness as a support and diagnostic tool, the Crestron Viewport may be preferred over development tools when uploading programs and projects.

The following sections define how one would upload a VT Pro-e project or upgrade the firmware of the STX-1700C. However, before attempting to upload or upgrade, it is necessary to establish communications.

Communication Settings

NOTE: For laptops and other PCs without a built-in RS-232 port, Crestron recommends the use of PCMCIA cards, rather than USB-to-serial adapters. If a USB-to-serial adapter must be used, Crestron has tested the following devices with good results:

Belkin (large model) F5U103
I/O Gear GUC232A (discontinued)
Keyspan USA-19QW (discontinued)

Other models, even from the same manufacturer, may not yield the same results.

The procedure in this section provides details for RS-232 communication between the PC and the control system. If TCP/IP communication is preferred, consult the latest version of the Crestron e-Control Reference Guide (Doc. 6052) or the respective Operations Guide for the control system. These documents are available from the Crestron website. Refer to the figure on the next page for a typical connection diagram when uploading files.

NOTE: Use a standard DB9 male to female “straight-through” cable.

Typical Connection Diagram when Uploading a Project from the PRO2 or equivalent

NOTE: If the control system in use has a 4-pin network connector rather than a modular (RJ-11-type) NET connector, use an ST-CBL interface cable (sold separately).

NOTE: To make a cable for either configuration, refer to the “Programming Cable Specifications” diagram after these notes.

NOTE: An adapter such as a CN-RJ11 (sold separately) is required when using the RJ-11 cable.

NOTE: The RJ-11 (part of ST-PK) and ST-CBL cables can also be found as part numbers CNSP-585 and CNSP-586, respectively, in the Crestron cable database. The database can be downloaded from the Crestron website.

NOTE: The procedure on the next page uses the ST-CBL.

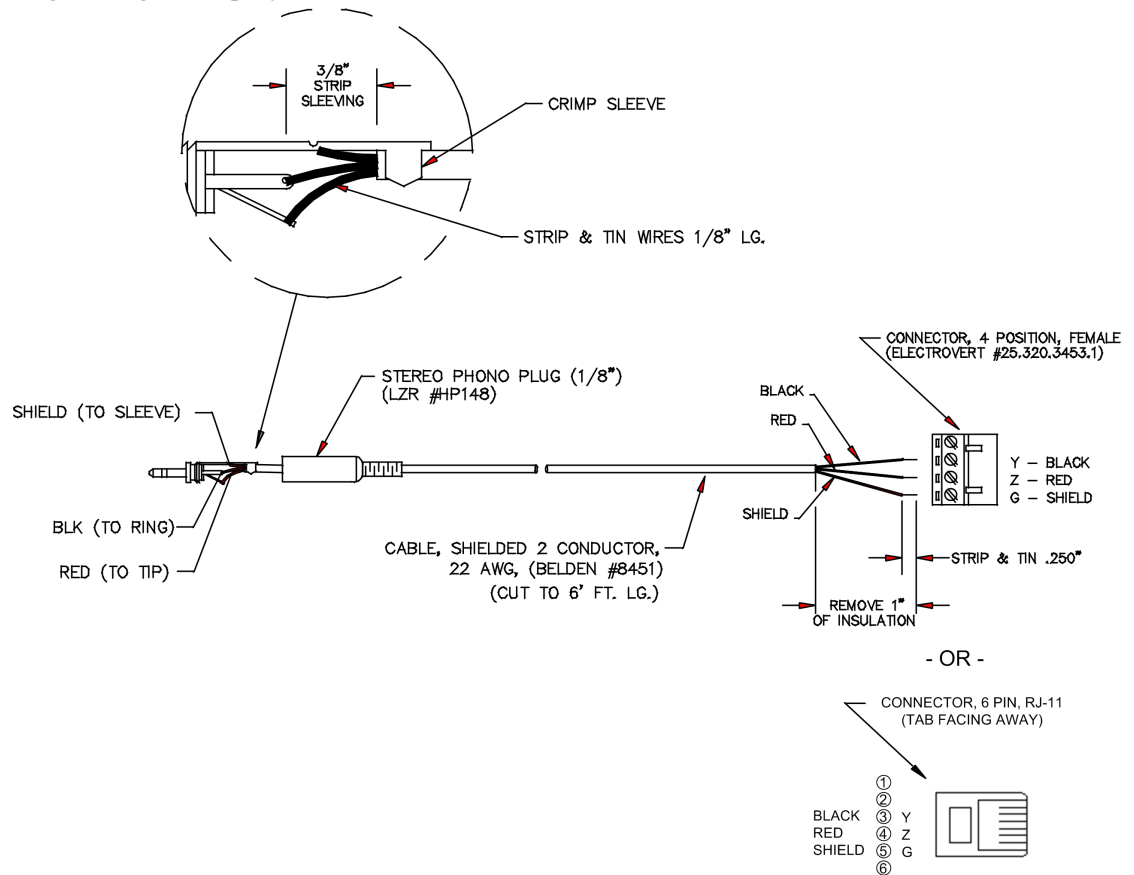
Programming Cable Specifications

1. Before making any connections to the touchpanel, verify that the control system is properly connected to the PC (using an RS-232 DB9 straight-through cable, Crestron P/N CNSP-587) and powered on.
2. Attach the stereo connector end of the ST-CBL to the touchpanel.
3. Attach the network connector end of the ST-CBL to the connector labeled NET on the control system.
4. Attach the appropriate external power pack or equivalent to touchpanel and plug into outlet. At the PC, make sure that no programs accessing the COM port of the PC are running.
5. Open the Crestron Viewport.
Either launch the stand-alone version of Viewport, or start SIMPL Windows or VT Pro-e, and from the menu bar, select **Tools | Viewport**.
6. From the Viewport menu, select **Setup | Communications settings** (alternatively, press **Alt+D**) to open the "Port Settings" window. Refer to the figures on the next page.

Accessing the “Port Settings” Window

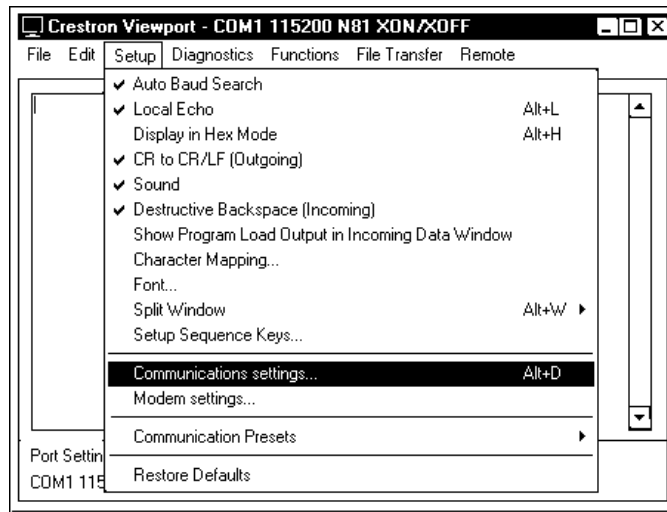

7. Select the **RS-232** connection type. Verify the available COM is selected. Verify that the baud rate is set to **115200** (PRO2 default), the parity is **None**, the data bits is **Eight**, the stop bits is **One**, *XON/XOFF* is not selected, and *RTS/CTS* is selected. Click the **OK** button to save the settings and close the window.

NOTE: If problems occur when transferring any Cresnet file (touchpanel project/firmware), lower the port speed baud rate to 38400 to match the Cresnet bus speed when transferring through a control system. Make sure **XModem** is selected from *Mode for Network Transfers*.

“Port Settings” Window

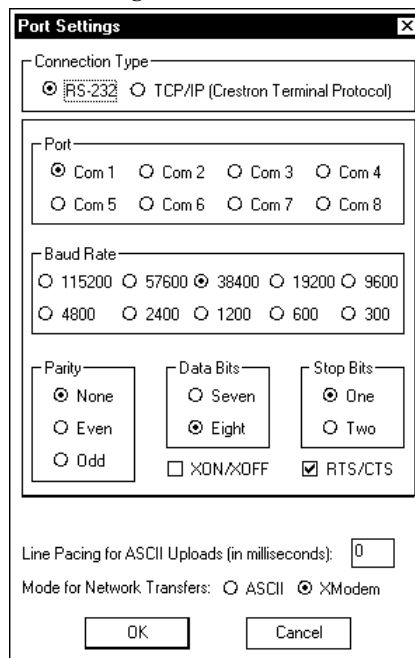

8. Proceed to “Uploading a VT Pro-e Project” on the next page, or to “Firmware Upgrade” that begins on page 25 as appropriate.

A compiled VT Pro-e file has the extension .vtz

Uploading a VT Pro-e Project

To upload a compiled VT Pro-e project to the STX-1700C, complete the following steps.

1. Make sure that “Communication Settings” that begins on page 20 has been performed.
2. As shown below, select **File Transfer | Send Touchpanel** (alternatively, depress **Alt+T**) from the Viewport menu.

Select Send Touchpanel

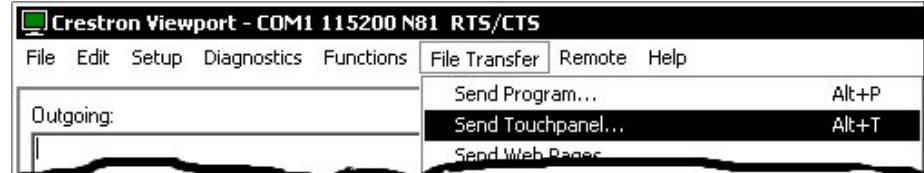

3. As shown below, select the Net ID of the STX-1700C and then click **OK**. The “Touchpanel Transfer” window appears (refer to the following graphic).

“Select Network ID” Window

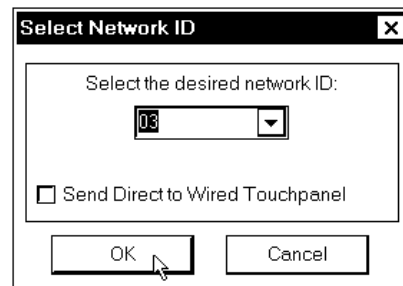

“Touchpanel Transfer” Window

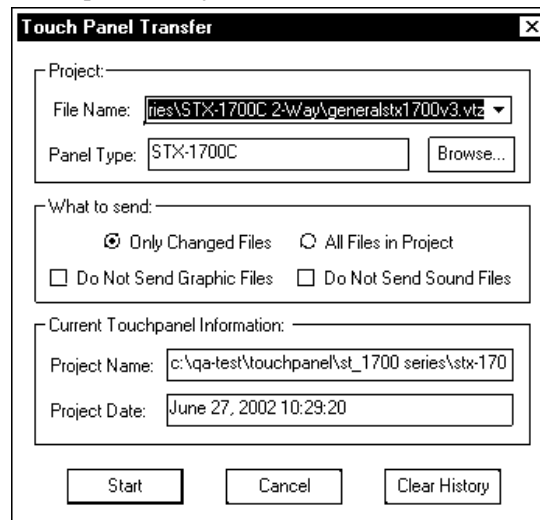

4. Click Browse. The “Open” window appears as shown on the next page.
5. Select the VT Pro-e (vtz) file and click **Open**. The transfer completes automatically.

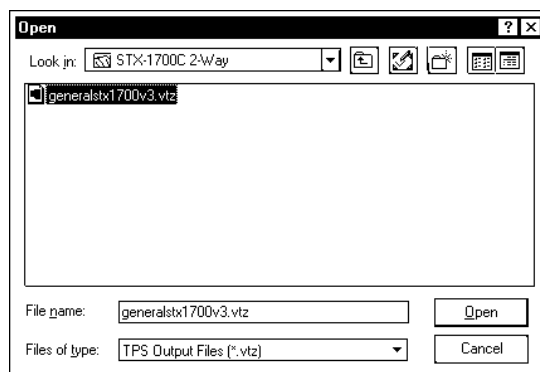
Select VTZ File

6. Disconnect the programming cable and the external power pack from the touchpanel.
7. Close the Viewport, exit VT Pro-e, and disconnect the programming cable from the PC and the control system.

Firmware Upgrades

A firmware upgrade file has the extension .csf

To take advantage of all the available features, it is important that the unit contains the latest firmware. Please check the Crestron website for the latest version of firmware. Not every product has a firmware upgrade, but as Crestron improves functions, adds new features, and extends the capabilities of its products, firmware upgrades are posted. To upgrade the STX-1700C firmware, complete the following steps.

1. Make sure that “Communication Settings” that begins on page 20 has been performed. Suggested baud rate is 38400.
2. As shown on next page, select **File Transfer | Update Touchpanel Firmware** from the Viewport menu.

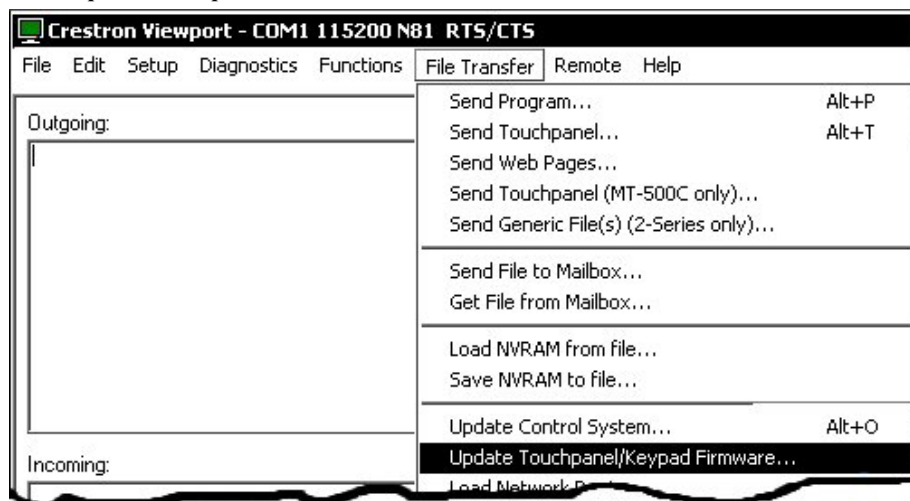
Select Update Touchpanel Firmware

3. As shown on the next page, select the Net ID of the STX-1700C and then click **OK**.

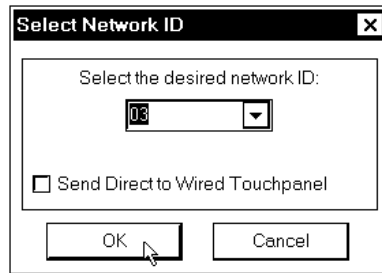
“Select Network ID” Window

4. As shown below, select the firmware (CSF) file and click **Open**. The transfer will complete automatically.

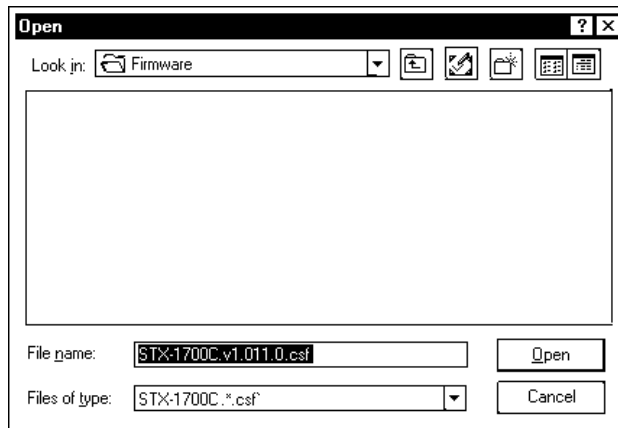
Select CSF File

5. Disconnect the programming cable and the external power pack from the touchpanel.

Problem Solving

Troubleshooting

The table below and continued on the next page provides corrective action for possible trouble situations. If further assistance is required, please contact a Crestron customer service representative.

NOTE: To minimize system diagnostics and troubleshooting, Crestron recommends defining the touchpanel as a wired unit in SIMPL Windows, then test functionality as a wired network device prior to testing the STRFGWX transceiver operations. This will help in determining whether there is a programming problem, an RF setting conflict, or RF interference in the environment.

NOTE: The diagram shown on page 21 is a typical “wired” hookup.

STX-1700C Troubleshooting

TROUBLE	POSSIBLE CAUSE(S)	CORRECTIVE ACTION
Touchpanel does not function.	No power to the touchpanel.	Confirm that battery pack is installed or external adapter is connected.
	Touchpanel is not communicating to the control system.	Poll the network (F4 in Viewport, VT Pro-e or SIMPL Windows) to verify communication.
Project cannot be uploaded to touchpanel.	Touchpanel is not powered up.	Touch the touchpanel to display a screen. Verify that the panel has power supplied to it, either battery or power pack.
	Communications error between PC and control system.	Verify upload preferences is set to the COM port being used to communicate to the control system.
	Incorrect Net ID setting.	Verify that panel Net ID matches the Net ID specified during upload. Refer to "Select Interface Menu".
	Problem with cable between control	Check the cable for damage or bad connections.
Wrong screens appear on touchpanel.	Wrong screens uploaded.	Upload correct screens. Refer to "Uploading a VT Pro-e Project".
Active area does not coincide with button on screen.	Touchpanel is incorrectly calibrated.	Remove power and then reapply power while holding finger to touchscreen (for about five seconds). The Main Menu appears. Select Touchscreen Calibration . The Calibration Menu appears. Select Perform Calibration and follow prompts. *
Touchpanel display is dark or too light.	Screen brightness is improperly set.	Hold a finger to the touchscreen for more than five seconds from power off. Set brightness using Setup menu.
Touchpanel exhibits slow operation.	Compressed graphics take time to decompress.	If there are no memory problems, decompressed graphics decrease the drawing time of panel pages.

* You can also use the **caltouch** command in Viewport to access the Calibration option.

(continued on next page)

STX-1700C Troubleshooting (continued)

TROUBLE	POSSIBLE CAUSE(S)	CORRECTIVE ACTION
Touchpanel display is dark.	Standby or power down timeout has elapsed.	Touch screen to reactivate.
	No power to the touchpanel.	Verify the power is properly applied and all connections are made.
Touchpanel operation appears unreliable.	Touchpanel is out of range. Refer to "Out of Range Feature" below.	Bring unit within range. Refer to "Specifications" for details.
		Use reserved join number 17509 in SIMPL Windows program to indicate when touchpanel is out of range.
		Install an additional STRFGWX near the area of use to accommodate roaming.
	RF Interference	Test as wired unit. If unit tests OK as wired touchpanel, and fails as wireless touchpanel, call Crestron Customer Support.
	Code related issues	Test as wired unit. If unit tests OK as wired touchpanel, and fails as wireless touchpanel, call Crestron Customer Support.
Touchpanel does not function and SIG LED on STRFGWX illuminates, but Rx or Tx LEDs do not.	Touchpanel RF ID is not set to match the RF ID assigned in the control system program.	Verify that RF IDs match. Refer to "Select Interface" on page 9 for details and RF ID parameters assigned in the program.
SIG LED on STRFGWX does not illuminate.	RF ID of Touchpanel and RF Channel of STRFGWX receiver do not match.	Verify that RF ID matches RF channel of the STRFGWX. Refer to "RF Setup" on page 9 for details and RF ID parameters assigned in the program.
Touchpanel screen changes without touching the screen.	Touchpanel went out and then in range while control system changed a screen.	Use reserved join number 17509 in SIMPL Windows program to indicate when touchpanel is out of range.

Out of Range Feature

The following describes touchpanel operation when the out of range feature is active or not active. Crestron recommends that you use the out of range feature.

Out of Range Feature Active

When the STX-1700C is out of range, it displays an out of range indication of your choice (refer to "Optional Pushbuttons" on page 18), and the touchpanel does not respond. Also the STRFGWX's TXD (transmit) LCD will flash every four to five seconds for approximately 30 seconds and then the LCD stops flashing (the unit stops transmitting if the touchpanel does not come into range in the allotted time). If the touchpanel comes into range BEFORE the STRFGWX stops transmitting, the display reverts to whatever screen the control system has active. If the touchpanel comes into range AFTER the STRFGWX stops transmitting, the user must touch the screen to activate the gateway and leave the out of range screen.

Out of Range Feature Not Active

When the STX-1700C is out of range, there is no out of range indication displayed. The only noticeable symptom on the touchpanel is that it does not respond. The STRFGWX's TXD LCD will flash every four to five seconds for approximately 30

seconds, and then the LCD stops flashing (the unit stops transmitting if the touchpanel does not come in range in the allotted time). If the touchpanel comes into range BEFORE the STRFGWX stops transmitting, the touchpanel will start responding and the display reverts to whatever screen the control system has active. If the touchpanel comes into range AFTER the STRFGWX stops transmitting, the user must touch the screen to activate the gateway. The screen may change if the control system sent a change to the touchpanel during the time it was out of range.

Further Inquiries

If you cannot locate specific information or have questions after reviewing this guide, please take advantage of Crestron's award winning customer service team by calling the Crestron corporate headquarters at 1-888-CRESTRON [1-888-273-7876]. For assistance in your local time zone, refer to the Crestron website (<http://www.crestron.com/>) for a listing of Crestron worldwide offices.

You can also log onto the online help section of the Crestron website to ask questions about Crestron products. First-time users will need to establish a user account to fully benefit from all available features.

Future Updates

As Crestron improves functions, adds new features, and extends the capabilities of the STX-1700C, additional information and programming examples may be made available as manual updates. These updates are solely electronic and serve as intermediary supplements prior to the release of a complete technical documentation revision.

Check the Crestron website periodically for manual update availability and its relevance. Updates are identified as an "Addendum."

Appendix A: Optimum RF Reception Guidelines

Many factors can affect the reliability of RF communication between an RF gateway and an RF touchpanel. While an effort has been made to determine operating specifications, some specifications are not constant. RF Communication can be limited by several factors including but not limited to EMI (electromagnetic interference), intervening objects, antenna orientation and receiver placement. To obtain maximum reliability and performance, some basic rules for installing RF transceivers are listed below.

Minimize Interference

RF reception range can be hindered by spurious EMI noise that may interfere with or mask the desired frequency thereby reducing useable range. EMI is generated by any electrical device at various RF noise levels depending on the device. Sources of EMI include computers, video equipment, digital processors, lighting dimmers, lighting ballasts, motors or any large AC source. Every effort should be made to separate any RF transceiver from these sources of RF noise including Audio Visual equipment in racks. If a gateway must be installed in an equipment rack, make sure you have ample separation between the equipment and the gateway.

Gateway Placement

Optimum reception for any RF transceiver is obtained by installing the gateway\ transceiver in an open area or shelf with a clear line of sight (no obstructions between gateway and receiver). Crestron recommends that the gateway is at least five to six feet high for best results. Avoid placing transceivers or transmitters at a low height or on the ground. Placing RF equipment near metal objects, walls, corners or metal enclosures will compromise RF propagation and reception. Try to avoid installing gateways in equipment racks, service rooms, electrical closets or in rooms other than that which the panel or transmitter is located.

Antenna Orientation

The antenna orientation on Crestron gateways has considerable effect on range and reliability. Optimum performance is obtained by setting the antenna horizontally (parallel to the ground). When absolutely necessary, two alternate orientations are possible – each will be less effective than the horizontal orientation:

- Point the antenna vertically
- Point the antenna at a right angle to the gateway.

These may allow for rack or equipment closet doors to be shut but these orientations may also compromise reception. Never point the antenna downward or directly parallel to the front panel, this will decrease range and reliability. Refer to illustrations on the next page for examples of the different antenna orientations.

NOTE: RF propagation is best from the sides of the antenna.

Horizontal Orientation

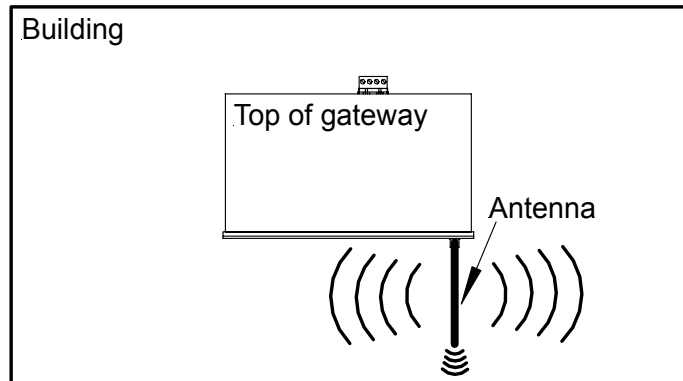

Vertical Orientation

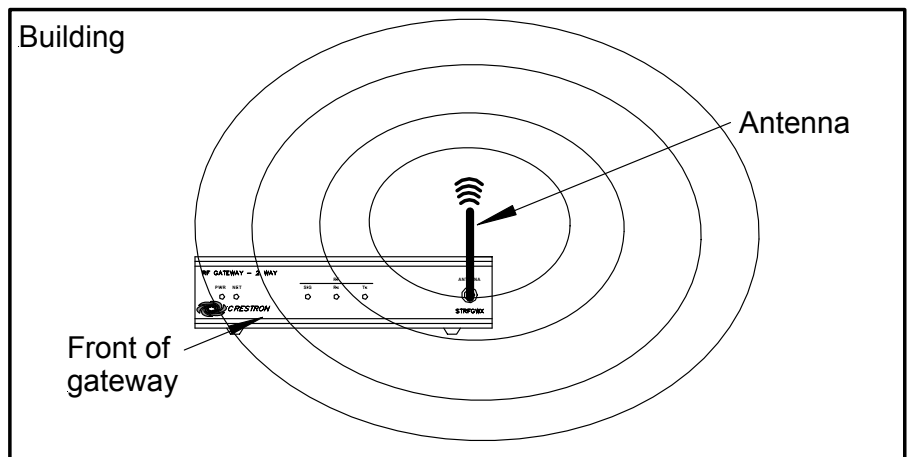

Right Angle Orientation

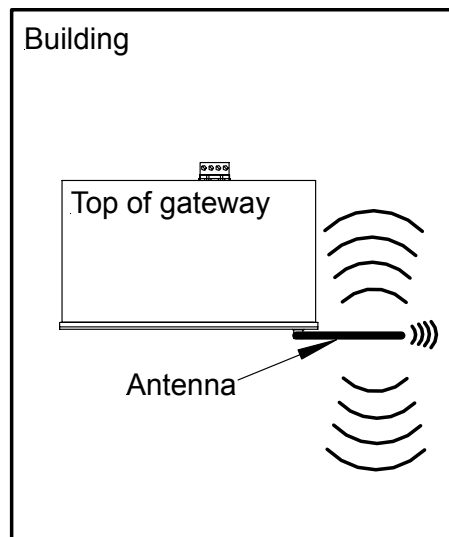

Appendix B: Installation of Optional Pushbuttons

The STX-1700C is supplied with ten optional pushbutton switches, blank buttons, and a bezel to accommodate the switches. As a further option, custom engraved black buttons (1700C-BTNB) or silver buttons (1700C-BTNS) can be designed and purchased via the Crestron Engraver software. Version 2.3.0.0 or later is available from the Crestron website.

Perform the following to install pushbuttons on the STX-1700C. Follow these same basic procedures to replace the blank buttons with the optional engraved buttons. A #1 Phillips screwdriver is required. Refer to the illustration below.

1. Place the touchpanel face down on a clean work surface.
2. Remove the four screws securing the front bezel to the base. Holding the bezel to the base, return the unit to its normal position and lift the bezel from the base.
3. Assemble the supplied membrane switches to the pushbutton sets. Notice that the pushbutton sets fit snugly on the membrane switches. (Refer to the following Notes.)
4. Put the assembled pushbuttons and switches in place (refer to the following Notes), and place the new bezel in position.

NOTE: The rear of the pushbuttons are marked 1-5 TOP and 6-10 TOP to ensure correct orientation when installed. Do not remove the plastic frame connecting the buttons together.

NOTE: Carefully position the switch/pushbutton assemblies on the printed circuit boards—edges should be aligned—and place the bezel over the pushbuttons to hold them in place.

5. Hold the bezel in position and turn the unit over on its face.
6. Reinstall the four screws to secure the bezel to the base. Tighten the screws, being careful not to strip the threads.
7. Verify that the pushbuttons function properly.

Optional Pushbutton Installation Diagram

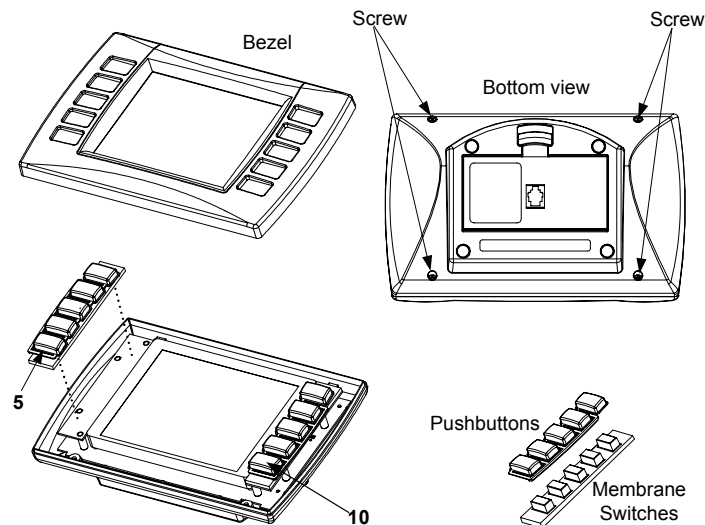

Software License Agreement

This License Agreement (“Agreement”) is a legal contract between you (either an individual or a single business entity) and Crestron Electronics, Inc. (“Crestron”) for software referenced in this guide, which includes computer software and, as applicable, associated media, printed materials, and “online” or electronic documentation (the “Software”).

BY INSTALLING, COPYING, OR OTHERWISE USING THE SOFTWARE, YOU REPRESENT THAT YOU ARE AN AUTHORIZED DEALER OF CRESTRON PRODUCTS OR A CRESTRON AUTHORIZED INDEPENDENT PROGRAMMER AND YOU AGREE TO BE BOUND BY THE TERMS OF THIS AGREEMENT. IF YOU DO NOT AGREE TO THE TERMS OF THIS AGREEMENT, DO NOT INSTALL OR USE THE SOFTWARE.

IF YOU HAVE PAID A FEE FOR THIS LICENSE AND DO NOT ACCEPT THE TERMS OF THIS AGREEMENT, CRESTRON WILL REFUND THE FEE TO YOU PROVIDED YOU (1) CLICK THE DO NOT ACCEPT BUTTON, (2) DO NOT INSTALL THE SOFTWARE AND (3) RETURN ALL SOFTWARE, MEDIA AND OTHER DOCUMENTATION AND MATERIALS PROVIDED WITH THE SOFTWARE TO CRESTRON AT: CRESTRON ELECTRONICS, INC., 15 VOLVO DRIVE, ROCKLEIGH, NEW JERSEY 07647, WITHIN 30 DAYS OF PAYMENT.

LICENSE TERMS

Crestron hereby grants You and You accept a nonexclusive, nontransferable license to use the Software (a) in machine readable object code together with the related explanatory written materials provided by Crestron (b) on a central processing unit (“CPU”) owned or leased or otherwise controlled exclusively by You, and (c) only as authorized in this Agreement and the related explanatory files and written materials provided by Crestron.

If this software requires payment for a license, you may make one backup copy of the Software, provided Your backup copy is not installed or used on any CPU. You may not transfer the rights of this Agreement to a backup copy unless the installed copy of the Software is destroyed or otherwise inoperable and You transfer all rights in the Software.

You may not transfer the license granted pursuant to this Agreement or assign this Agreement without the express written consent of Crestron.

If this software requires payment for a license, the total number of CPU’s on which all versions of the Software are installed may not exceed one per license fee (1) and no concurrent, server or network use of the Software (including any permitted back-up copies) is permitted, including but not limited to using the Software (a) either directly or through commands, data or instructions from or to another computer (b) for local, campus or wide area network, internet or web hosting services; or (c) pursuant to any rental, sharing or “service bureau” arrangement.

The Software is designed as a software development and customization tool. As such Crestron cannot and does not guarantee any results of use of the Software or that the Software will operate error free and You acknowledge that any development that You perform using the Software or Host Application is done entirely at Your own risk.

The Software is licensed and not sold. Crestron retains ownership of the Software and all copies of the Software and reserves all rights not expressly granted in writing.

OTHER LIMITATIONS

You must be an Authorized Dealer of Crestron products or a Crestron Authorized Independent Programmer to install or use the Software. If Your status as a Crestron Authorized Dealer or Crestron Authorized Independent Programmer is terminated, Your license is also terminated.

You may not rent, lease, lend, sublicense, distribute or otherwise transfer or assign any interest in or to the Software.

You may not reverse engineer, decompile, or disassemble the Software.

You agree that the Software will not be shipped, transferred or exported into any country or used in any manner prohibited by the United States Export Administration Act or any other export laws, restrictions or regulations (“Export Laws”). By downloading or installing the Software You (a) are certifying that You are not a national of Cuba, Iran, Iraq, Libya, North Korea, Sudan, or Syria or any country to which the United States embargoes goods (b) are certifying that You are not otherwise prohibited from receiving the Software and (c) You agree to comply with the Export Laws.

If any part of this Agreement is found void and unenforceable, it will not affect the validity of the balance of the Agreement, which shall remain valid and enforceable according to its terms. This Agreement may only be modified by a writing signed by an authorized officer of Crestron. Updates may be licensed to You by Crestron with additional or different terms. This is the entire agreement between Crestron and You relating to the Software and it supersedes any prior representations, discussions, undertakings, communications or advertising relating to the Software. The failure of either party to enforce any right or take any action in the event of a breach hereunder shall constitute a waiver unless expressly acknowledged and set forth in writing by the party alleged to have provided such waiver.

If You are a business or organization, You agree that upon request from Crestron or its authorized agent, You will within thirty (30) days fully document and certify that use of any and all Software at the time of the request is in conformity with Your valid licenses from Crestron or its authorized agent.

Without prejudice to any other rights, Crestron may terminate this Agreement immediately upon notice if you fail to comply with the terms and conditions of this Agreement. In such event, you must destroy all copies of the Software and all of its component parts.

PROPRIETARY RIGHTS

Copyright. All title and copyrights in and to the Software (including, without limitation, any images, photographs, animations, video, audio, music, text, and “applets” incorporated into the Software), the accompanying media and printed materials, and any copies of the Software are owned by Crestron or its suppliers. The Software is protected by copyright laws and international treaty provisions. Therefore, you must treat the Software like any other copyrighted material, subject to the provisions of this Agreement.

Submissions. Should you decide to transmit to Crestron’s website by any means or by any media any materials or other information (including, without limitation, ideas, concepts or techniques for new or improved services and products), whether as information, feedback, data, questions, comments, suggestions or the like, you agree such submissions are unrestricted and shall be deemed non-confidential and you automatically grant Crestron and its assigns a non-exclusive, royalty-free, worldwide, perpetual, irrevocable license, with the right to sublicense, to use, copy, transmit, distribute, create derivative works of, display and perform the same.

Trademarks. CRESTRON and the Swirl Logo are registered trademarks of Crestron Electronics, Inc. You shall not remove or conceal any trademark or proprietary notice of Crestron from the Software including any back-up copy.

GOVERNING LAW

This Agreement shall be governed by the laws of the State of New Jersey, without regard to conflicts of laws principles. Any disputes between the parties to the Agreement shall be brought in the state courts in Bergen County, New Jersey or the federal courts located in the District of New Jersey. The United Nations Convention on Contracts for the International Sale of Goods, shall not apply to this Agreement.

CRESTRON LIMITED WARRANTY

CRESTRON warrants that: (a) the Software will perform substantially in accordance with the published specifications for a period of ninety (90) days from the date of receipt, and (b) that any hardware accompanying the Software will be subject to its own limited warranty as stated in its accompanying written material. Crestron shall, at its option, repair or replace or refund the license fee for any Software found defective by Crestron if notified by you within the warranty period. The foregoing remedy shall be your exclusive remedy for any claim or loss arising from the Software.

CRESTRON shall not be liable to honor warranty terms if the product has been used in any application other than that for which it was intended, or if it as been subjected to misuse, accidental damage, modification, or improper installation procedures. Furthermore, this warranty does not cover any product that has had the serial number or license code altered, defaced, improperly obtained, or removed.

Notwithstanding any agreement to maintain or correct errors or defects Crestron, shall have no obligation to service or correct any error or defect that is not reproducible by Crestron or is deemed in Crestron’s reasonable discretion to have resulted from (1) accident; unusual stress; neglect; misuse; failure of electric power, operation of the Software with other media not meeting or not maintained in accordance with the manufacturer’s specifications; or causes other than ordinary use; (2) improper installation by anyone other than Crestron or its authorized agents of the Software that deviates from any operating procedures established by Crestron in the material and files provided to You by Crestron or its authorized agent; (3) use of the Software on unauthorized hardware; or (4) modification of, alteration of, or additions to the Software undertaken by persons other than Crestron or Crestron’s authorized agents.

ANY LIABILITY OF CRESTRON FOR A DEFECTIVE COPY OF THE SOFTWARE WILL BE LIMITED EXCLUSIVELY TO REPAIR OR REPLACEMENT OF YOUR COPY OF THE SOFTWARE WITH ANOTHER COPY OR REFUND OF THE INITIAL LICENSE FEE CRESTRON RECEIVED FROM YOU FOR THE DEFECTIVE COPY OF THE PRODUCT. THIS WARRANTY SHALL BE THE SOLE AND EXCLUSIVE REMEDY TO YOU. IN NO EVENT SHALL CRESTRON BE LIABLE FOR INCIDENTAL, CONSEQUENTIAL, SPECIAL OR PUNITIVE DAMAGES OF ANY KIND (PROPERTY OR ECONOMIC DAMAGES INCLUSIVE), EVEN IF A CRESTRON REPRESENTATIVE HAS BEEN ADVISED OF THE POSSIBILITY OF SUCH DAMAGES OR OF ANY CLAIM BY ANY THIRD PARTY. CRESTRON MAKES NO WARRANTIES, EXPRESS OR IMPLIED, AS TO TITLE OR INFRINGEMENT OF THIRD-PARTY RIGHTS, MERCHANTABILITY OR FITNESS FOR ANY PARTICULAR PURPOSE, OR ANY OTHER WARRANTIES, NOR AUTHORIZES ANY OTHER PARTY TO OFFER ANY WARRANTIES, INCLUDING WARRANTIES OF MERCHANTABILITY FOR THIS PRODUCT. THIS WARRANTY STATEMENT SUPERSEDES ALL PREVIOUS WARRANTIES.

Return and Warranty Policies

Merchandise Returns / Repair Service

1. No merchandise may be returned for credit, exchange, or service without prior authorization from CRESTRON. To obtain warranty service for CRESTRON products, contact the factory and request an RMA (Return Merchandise Authorization) number. Enclose a note specifying the nature of the problem, name and phone number of contact person, RMA number, and return address.
2. Products may be returned for credit, exchange, or service with a CRESTRON Return Merchandise Authorization (RMA) number. Authorized returns must be shipped freight prepaid to CRESTRON, 6 Volvo Drive, Rockleigh, N.J., or its authorized subsidiaries, with RMA number clearly marked on the outside of all cartons. Shipments arriving freight collect or without an RMA number shall be subject to refusal. CRESTRON reserves the right in its sole and absolute discretion to charge a 15% restocking fee, plus shipping costs, on any products returned with an RMA.
3. Return freight charges following repair of items under warranty shall be paid by CRESTRON, shipping by standard ground carrier. In the event repairs are found to be non-warranty, return freight costs shall be paid by the purchaser.

CRESTRON Limited Warranty

CRESTRON ELECTRONICS, Inc. warrants its products to be free from manufacturing defects in materials and workmanship under normal use for a period of three (3) years from the date of purchase from CRESTRON, with the following exceptions: disk drives and any other moving or rotating mechanical parts, pan/tilt heads and power supplies are covered for a period of one (1) year; touchscreen display and overlay components are covered for 90 days; batteries and incandescent lamps are not covered.

This warranty extends to products purchased directly from CRESTRON or an authorized CRESTRON dealer. Purchasers should inquire of the dealer regarding the nature and extent of the dealer's warranty, if any.

CRESTRON shall not be liable to honor the terms of this warranty if the product has been used in any application other than that for which it was intended, or if it has been subjected to misuse, accidental damage, modification, or improper installation procedures. Furthermore, this warranty does not cover any product that has had the serial number altered, defaced, or removed.

This warranty shall be the sole and exclusive remedy to the original purchaser. In no event shall CRESTRON be liable for incidental or consequential damages of any kind (property or economic damages inclusive) arising from the sale or use of this equipment. CRESTRON is not liable for any claim made by a third party or made by the purchaser for a third party.

CRESTRON shall, at its option, repair or replace any product found defective, without charge for parts or labor. Repaired or replaced equipment and parts supplied under this warranty shall be covered only by the unexpired portion of the warranty.

Except as expressly set forth in this warranty, CRESTRON makes no other warranties, expressed or implied, nor authorizes any other party to offer any warranty, including any implied warranties of merchantability or fitness for a particular purpose. Any implied warranties that may be imposed by law are limited to the terms of this limited warranty. This warranty statement supercedes all previous warranties.

Trademark Information

All brand names, product names, and trademarks are the sole property of their respective owners. Windows is a registered trademark of Microsoft Corporation. Windows95/98/Me/XP and WindowsNT/2000 are trademarks of Microsoft Corporation.



Crestron Electronics, Inc.
15 Volvo Drive Rockleigh, NJ 07647
Tel: 888.CRESTRON
Fax: 201.767.7576
www.crestron.com

Operations Guide – DOC. 6226A
12.04

Specifications subject to
change without notice.