

Crestron PW-1215WU Power Pack

Installation Guide



This document was prepared by the Technical Documentation department at:



Crestron Electronics, Inc.

15 Volvo Drive
Rockleigh, NJ 07647
1-888-CRESTRON

Regulatory Compliance

This product is Listed to applicable UL Standards and requirements by Underwriters Laboratories Inc.



As of the date of manufacture, the PW-1215WU has been tested and found to comply with specifications for CE marking, standards per EMC and Radiocommunications Compliance Labelling and Japan electrical appliance and material safety law.



The PW-1215WU complies with section 301 of the Energy Independence and Securities Act (EISA).

Energy Efficiency Level



Description

The PW-1215WU is a regulated universal LPS (limited power source) power pack that is used to power a 12 Volt Crestron® product from a standard AC receptacle (100-240 VAC, 50-60 Hz). It is designed for indoor use only.

CAUTION: Connect this power pack only to a Crestron device that is rated at 12 Volts (regulated) and no more than 1.5 Amps. Plugging this power pack into a Crestron device that has a different rating could damage the device or the power pack.

Specifications

Specifications for the PW-1215WU are listed in the following table.

PW-1215WU Specifications

SPECIFICATION	DETAILS
Power Input Output	100-240 Volts AC, 50/60 Hz 12 Volts DC @ 1.5 Amps, regulated, using male barrel (5.5 x 2.5 mm) connector
Cable Length	6 feet (~1.8 meters)
Environmental Temperature Humidity	41° to 104° F (5° to 40° C) 10% to 90% RH (non-condensing)
Dimensions Height Width Depth	2.90 in (74 mm) 1.72 in (44 mm) 1.38 in (35 mm) without adapter
Weight	5 oz (144 g)

PW-1215WU Power Pack Adapter Insert Set

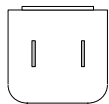

North America
Japan

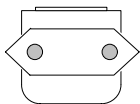

Europe
South America

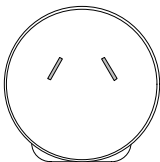

Australia
China

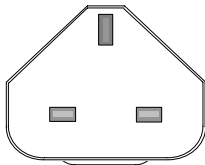

United Kingdom
Hong Kong
Singapore

PW-1215WU Power Pack Hookup

AC
Receptacle

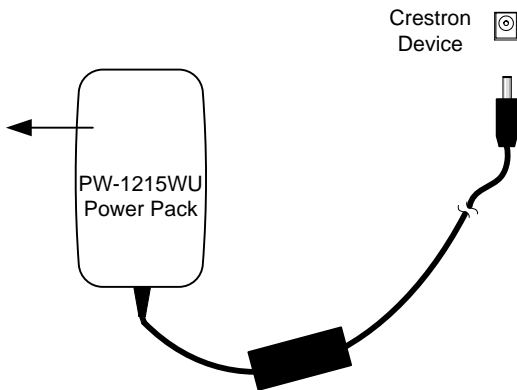
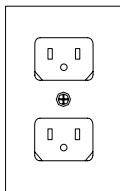

Crestron
Device

Setup

Complete the following steps to properly set up and connect the power pack.

1. Slide the thumb switch on the PW-1215WU downward and remove the protective insert from the unit by pulling the bottom part toward you, then sliding it downward to release the tab.
2. Select the proper adapter insert from the set of four.
3. Slide the thumb switch on the PW-1215WU downward and install the adapter insert into the unit, top part first to engage the tab, then press the bottom part into place.
4. Attach the barrel connector to the device to be powered.
5. Insert the power pack into an active AC receptacle.

PW-1215WU Power Pack (Shown With and Without Protective Insert)

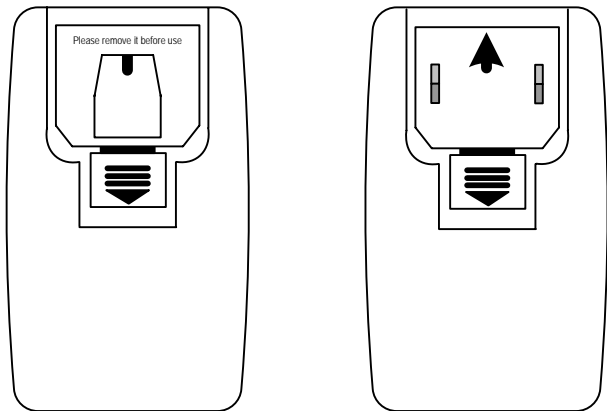

Further Inquiries

If you cannot locate specific information or have questions after reviewing this guide, please take advantage of Crestron's award winning customer service team by calling Crestron at 1-888-CRESTRON [1-888-273-7876].

You can also log onto the online help section of the Crestron website (www.crestron.com/onlinehelp) to ask questions about Crestron products. First time users will need to establish a user account to fully benefit from all available features.

Return and Warranty Policies

Merchandise Returns / Repair Service

1. No merchandise may be returned for credit, exchange or service without prior authorization from CRESTRON. To obtain warranty service for CRESTRON products, contact an authorized CRESTRON dealer. Only authorized CRESTRON dealers may contact the factory and request an RMA (Return Merchandise Authorization) number. Enclose a note specifying the nature of the problem, name and phone number of contact person, RMA number and return address.
2. Products may be returned for credit, exchange or service with a CRESTRON Return Merchandise Authorization (RMA) number. Authorized returns must be shipped freight prepaid to CRESTRON, 6 Volvo Drive, Rockleigh, N.J. or its authorized subsidiaries, with RMA number clearly marked on the outside of all cartons. Shipments arriving freight collect or without an RMA number shall be subject to refusal. CRESTRON reserves the right in its sole and absolute discretion to charge a 15% restocking fee plus shipping costs on any products returned with an RMA.
3. Return freight charges following repair of items under warranty shall be paid by CRESTRON, shipping by standard ground carrier. In the event repairs are found to be non-warranty, return freight costs shall be paid by the purchaser.

CRESTRON Limited Warranty

CRESTRON ELECTRONICS, Inc. warrants its products to be free from manufacturing defects in materials and workmanship under normal use for a period of three (3) years from the date of purchase from CRESTRON, with the following exceptions: disk drives and any other moving or rotating mechanical parts, pan/tilt heads and power supplies are covered for a period of one (1) year; touchscreen display and overlay components are covered for 90 days; batteries and incandescent lamps are not covered.

This warranty extends to products purchased directly from CRESTRON or an authorized CRESTRON dealer. Purchasers should inquire of the dealer regarding the nature and extent of the dealer's warranty, if any.

CRESTRON shall not be liable to honor the terms of this warranty if the product has been used in any application other than that for which it was intended or if it has been subjected to misuse, accidental damage, modification or improper installation procedures. Furthermore, this warranty does not cover any product that has had the serial number altered, defaced or removed.

This warranty shall be the sole and exclusive remedy to the original purchaser. In no event shall CRESTRON be liable for incidental or consequential damages of any kind (property or economic damages inclusive) arising from the sale or use of this equipment. CRESTRON is not liable for any claim made by a third party or made by the purchaser for a third party.

CRESTRON shall, at its option, repair or replace any product found defective, without charge for parts or labor. Repaired or replaced equipment and parts supplied under this warranty shall be covered only by the unexpired portion of the warranty.

Except as expressly set forth in this warranty, CRESTRON makes no other warranties, expressed or implied, nor authorizes any other party to offer any warranty, including any implied warranties of merchantability or fitness for a particular purpose. Any implied warranties that may be imposed by law are limited to the terms of this limited warranty. This warranty statement supersedes all previous warranties.

Trademark Information

All brand names, product names and trademarks are the sole property of their respective owners. Windows is a registered trademark of Microsoft Corporation. Windows 95/98/Me/XP/Vista/7 and Windows NT/2000 are trademarks of Microsoft Corporation.



Crestron Electronics, Inc.
15 Volvo Drive Rockleigh, NJ 07647
Tel: 888.CRESTRON
Fax: 201.767.7576
www.crestron.com

Installation Guide - DOC. 6971A
(2027249)
08.10

Specifications subject to
change without notice.