

Crestron CLC-1DIMFLV2EX-24V
Wireless In-Ceiling 0-10V Dimmer
Installation Guide



Further Inquiries
If you cannot locate specific information or have questions after reviewing this guide, please take advantage of Crestron's award winning customer service team by calling Crestron at 1-888-CRESTRON [1-888-273-7876]. For assistance in your region, please refer to the Crestron Web site (www.crestron.com) for a listing of Crestron worldwide offices.

You can also log onto the online help section of the Crestron Web site (www.crestron.com/onlinehelp) to ask questions about Crestron products. First-time users will need to establish a user account to fully benefit from all available features.

Future Updates
As Crestron improves functions, adds new features and extends the capabilities of the CLC-1DIMFLV2EX-24V units, additional information may be made available as manual updates. These updates are solely electronic and serve as intermediary supplements prior to the release of a complete technical documentation revision. Check the Crestron Web site periodically for manual update availability and its relevance. Updates are identified as an "Addendum" in the Download column.

WARNING: To avoid fire, shock, or death; turn off power at circuit breaker or fuse and test that power is off before wiring!

- NOTES:** Observe the following points.
- To be installed and/or used in accordance with appropriate electrical codes and regulations.
 - This product should be installed by a qualified electrician
 - Sensors must be mounted on a vibration free surface.

PREPARING AND CONNECTING WIRES
Strip the ends of the wires approximately 1/4 in (6 mm). Use care to avoid nicking the conductors. Twist together the ends of the wires that share a connection.

Crestron Electronics, Inc. **Installation Guide-DOC. 7114A**
15 Volvo Drive Rockleigh, NJ 07647 **(2029284)**
Tel: 888.CRESTRON **10.11**
Fax: 201.767.7576 Specifications subject to
www.crestron.com change without notice.



Regulatory Compliance

Federal Communications Commission (FCC) Compliance Statement
This device complies with part 15 of the FCC Rules. Operation is subject to the following conditions:
(1) This device may not cause harmful interference and (2) this device must accept any interference received, including interference that may cause undesired operation.
CAUTION: Changes or modifications not expressly approved by the manufacturer responsible for compliance could void the user's authority to operate the equipment.
NOTE: This equipment has been tested and found to comply with the limits for a Class B digital device, pursuant to part 15 of the FCC Rules. These limits are designed to provide reasonable protection against harmful interference in a residential installation. This equipment generates, uses and can radiate radio frequency energy and, if not installed and used in accordance with the instructions, may cause harmful interference to radio communications. However, there is no guarantee that interference will not occur in a particular installation. If this equipment does cause harmful interference to radio or television reception, which can be determined by turning the equipment off and on, the user is encouraged to try to correct the interference by one or more of the following measures:

- Reorient or relocate the receiving antenna
- Increase the separation between the equipment and receiver
- Connect the equipment into an outlet on a circuit different from that to which the receiver is connected
- Consult the dealer or an experienced radio/TV technician for help

(Continued on the Following Page)

DESCRIPTION

The CLC-1DIMFLV2EX-24V dimmer is designed to work as part of a complete Crestron® lighting solution, communicating via the infiNET EX™ wireless mesh network. This dimmer provides the ability to control two EMerge Alliance® compatible 0-10V lighting fixtures independently. The compact unit is easily hidden in the ceiling by mounting next to or on the lighting fixture.

Two Channel 0-10V Dimming
The CLC-1DIMFLV2EX-24V supports dimming with 0-10 Volt fluorescent ballasts. There are terminals for wiring in two channels, each independently controllable by the Crestron system. Each channel can support a load of up to 2.5 Amps. The unit has terminals for wiring a momentary switch for local on/off and dimming control.

infiNET EX Communications
Built on steadfast infiNET technology, infiNET EX is the new standard in 2-way wireless connectivity. So robust, infiNET EX can handle installations in even the most urban settings. The redundant nature of its mesh networking technology means that a command will never be missed, resulting in faultless operation - something that is of the utmost importance when it comes to lighting control and home automation. The CLC-1DIMFLV2EX-24V harnesses this cutting edge wireless connectivity which affords it a level of robustness and dependability above other solutions.

Specifications
Specifications for the CLC-1DIMFLV2EX-24V are listed in the following table.

CLC-1DIMFLV2EX-24V Specifications

SPECIFICATION	DETAILS
Input Voltage	24 Volts DC, non-polarized, from Armstrong® DC Flexzone™ ceiling grid
Load Ratings	
Number of Channels	2
Maximum Switched Load per Channel	2.5 Amps @ 24 Volts DC (60W)
Dim Load Types	EMerge Alliance compliant 0-10V Fluorescent, 0-10V LED; 65 mA max current sink per channel
Switch Load Types	EMerge Alliance compliant 24 Volts DC fluorescent ballast, 24 Volts DC LED
Environmental	
Temperature	32° F to 104° F (0° C to 40° C)
Humidity	10 to 90% RH (non-condensing)
Dimensions	
Height	7 in (178 mm)
Width	2 1/8 in (55 mm)
Depth	1 5/8 in (41 mm)
Weight	7 oz (199 g)
Operating Frequency	2400 MHz to 2483.5 MHz (802.15.4 compliant)
Operating Ranges ¹	
Device to Device	100 ft (30 m) indoors; 175 ft (55 m) outdoors
Device to Gateway	150 feet (45 m) indoors; 250 ft (75 m) outdoors
Default RF ID	01
Enclosure	Plastic
2-Series Control System Update File	Version 4.001.1012 or later ²
3-Series Control System Update File	Version 1.2.0 or later ²
CEN-RFGW-EX Update File	Version 2.1.37 or later ²

- The range is dependent on its placement and the building in which it is used. The construction of the building, obstructions and RF interference from other devices are factors determining the effective range of the unit.
- The latest software versions can be obtained from the Crestron Web site. Refer to the NOTE following these footnotes.

NOTE: Crestron software and any files on the Web site are for authorized Crestron dealers and Crestron Authorized Independent Programmers (CAIP) only. New users may be required to register to obtain access to certain areas of the site (including the FTP site).

Important Notes
Read before wiring and installation.

CAUTION: TO REDUCE THE RISK OF OVERHEATING AND POSSIBLE DAMAGE TO OTHER EQUIPMENT, DO NOT INSTALL TO CONTROL A RECEPTACLE OR A TRANSFORMER-SUPPLIED APPLIANCE.
ATTENTION: GRADATEURS COMMANDANT UN BALLAST-AFIN DE REDUIRE LE RISQUE DE SURCHAUFFE ET LA POSSIBILITE D'ENDOMMAGEMENT A D'AUTRES MATERIELS, NE PAS INSTALLER POUR COMMANDER UNE PRISE OU UN APPAREIL ALIMENTE PAR UN TRANSFORMATEUR.

CAUTION: To be installed with 14 AWG (2.5 mm²) wire that complies with local electrical codes.

NOTE:

- Codes: Install in accordance with all local and national electrical codes.
- Wiring: Use copper wire only. For supply connections, use wires rated for at least 167° F (75° C).
- Lamp Type: For use with permanently installed EMerge Alliance approved loads: fluorescent ballast, neon/cold cathode, 0-10 V Fluorescent, 0-10 V LED.
- Spacing: If mounting one device above another, leave at least 4 1/2" (115 mm) vertical space between them.

NOTE:

- Record the serial number of the device before installation. (Refer to CLC(I)-SERIES IMPORTANT NOTICE (Doc. 7179) included in the box).
- Device must remain in an accessible location when placed into *Acquire* mode and joined to a gateway.

Physical Description
This section provides information on the connections, controls and indicators available on the CLC-1DIMFLV2EX-24V.

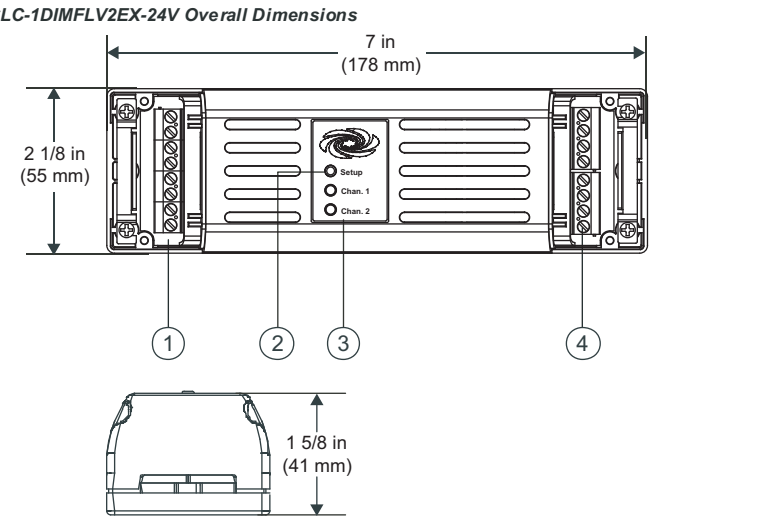

Connectors, Controls & Indicators

#	CONNECTORS, CONTROLS & INDICATORS	DESCRIPTION
1		24V: (2) Screw terminals for connecting to 24 VDC rail via load device cable assembly; terminals are non-polarized +: (1) Screw terminal provides +24 VDC to power sensors R: (1) Screw terminal for connecting to remote switch O: (1) Screw terminal for connecting to occupancy sensor P: (1) Screw terminal for connecting to photocell -: (1) Screw terminal for connecting common to sensors
2	Setup	Miniature push button for joining an infiNET EX network.
3	Chan. 1 / Chan. 2	Green LED indicates that the load is on.
4		(8) screw terminals for dimmable fixtures. -1: (1) Screw terminal for (-) 0-10V signal, channel 1 +1: (1) Screw terminal for (+) 0-10V signal, channel 1 -2: (1) Screw terminal for (-) 0-10V signal, channel 2 +2: (1) Screw terminal for (+) 0-10V signal, channel 2 SW 1: (full circle) (1) Screw terminal for common, channel 1 SW 1: (half circle) (1) Screw terminal for switched 24 VDC, channel 1 SW 2: (full circle) (1) Screw terminal for common, channel 2 SW 2: (half circle) (1) Screw terminal for switched 24 VDC, channel 2

WIRING

WARNING: Turn off power to the ceiling grid. Wiring with power on can result in serious personal injury and damage to the device.
CAUTION: New installations should be checked for short circuits prior to installing a CLC-1DIMFLV2EX-24V dimmer. With power off, close the circuit and restore power. If the loads do not work or a power supply indicates an over-current condition, check and correct the wiring or fixture (if necessary). Install the switch only when the short is no longer present. The warranty is void if the switch is installed and operated with a shorted load.

Typical Wiring Diagram

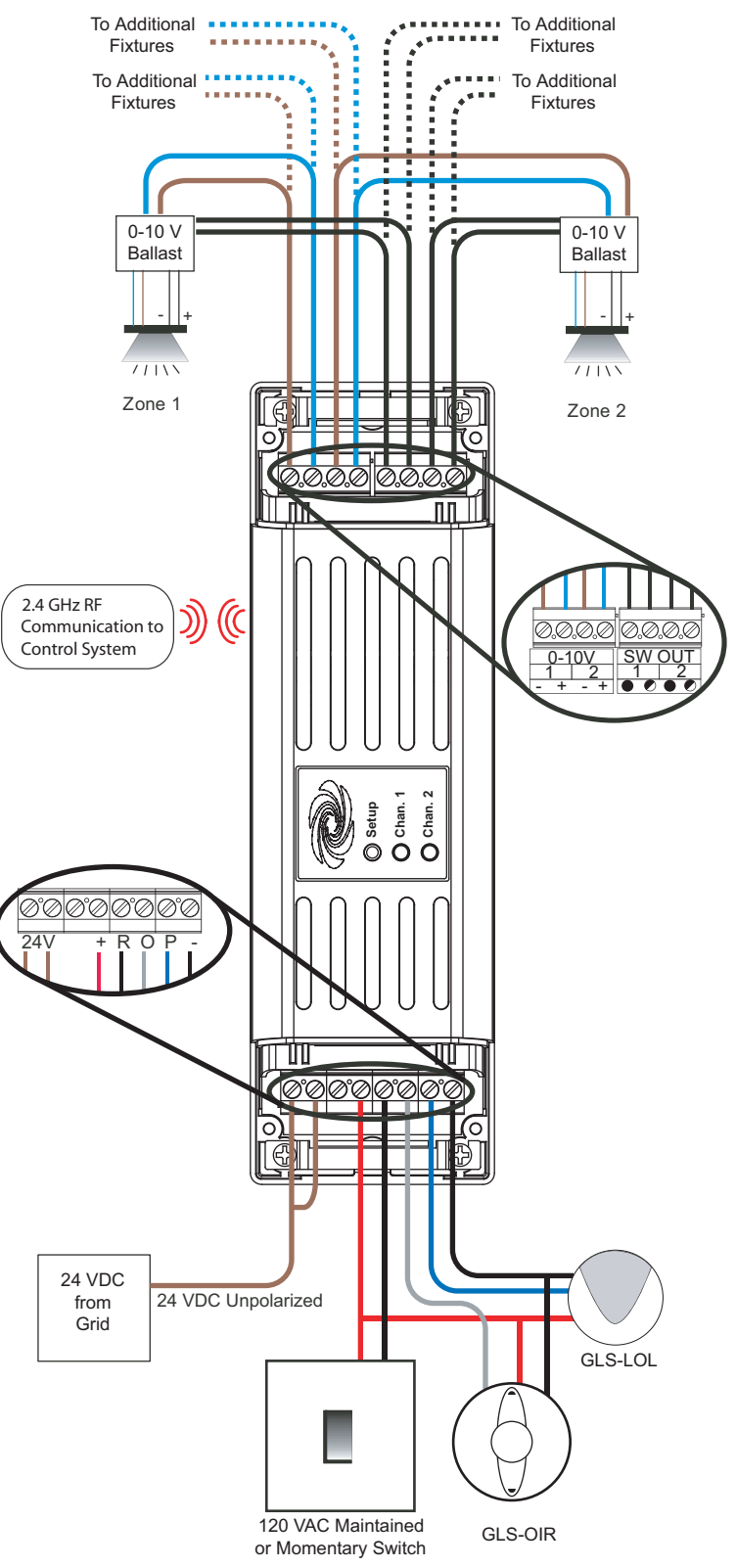

NOTE: Depending on the application only the 0-10V connections may be needed. Connecting the switched wires may not be necessary.

REMOTE SWITCH WIRING OPTIONS

Remote Maintained (Single Switch)

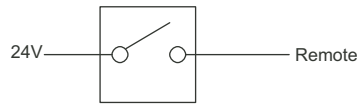

Remote Maintained (Multi-Way)

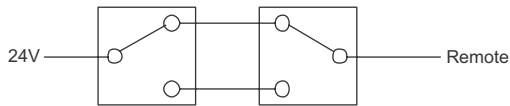

Remote Maintained (Multi-Way)

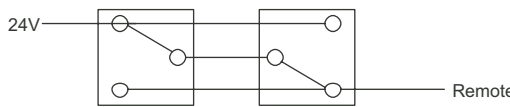

Remote Momentary (Single Switch)

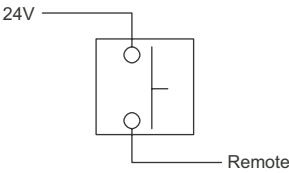

Remote Momentary (Multi-Way)

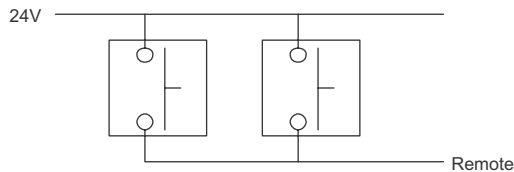

INSTALLATION

Complete the following procedure to install a CLC-1DIMFLV2EX-24V dimmer.

1. Disconnect power from the ceiling grid.

CAUTION: The CLC-1DIMFLV2EX-24V should be mounted in a well ventilated and dry area.

2. Identify the installation location for CLC-1DIMFLV2EX-24V.
3. Identify and tag the 24V, +, R, O and P wires.
4. Remove the end caps of the CLC-1DIMFLV2EX-24V by unfastening two screws (as shown below).

Removing the End Caps

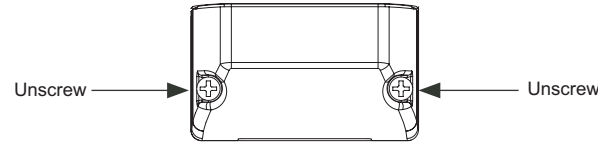

5. Loosen the strain relief clamp screw and rotate the clamp to the side (as shown below) to allow for wiring.

Rotating the Strain Relief Clamp

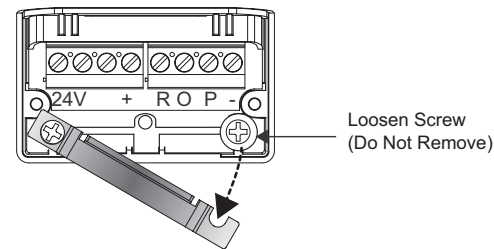

6. If mounting the device with screws (optional), mount the CLC-1DIMFLV2EX-24V using (2) m3 x 0.05 screws (not supplied).

Screw Down Mounting

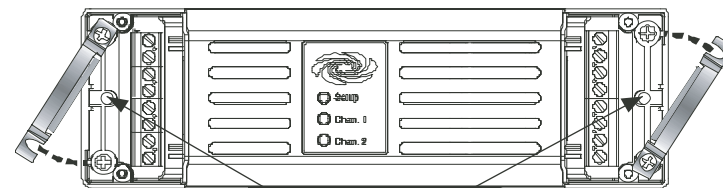

Mounting Screw Locations

7. Wire device as shown in the illustration on the previous page.

CAUTION: To be installed with maximum 14 AWG (2.5 mm²) wire.

8. Tuck wires under strain relief clamps and tighten the strain relief clamp screws

Fastening the Strain Relief Clamp

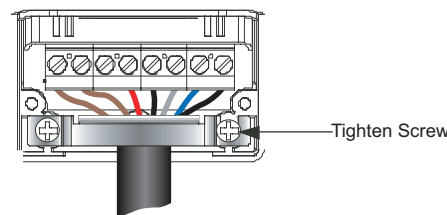

9. Replace the end caps.
10. With the device still accessible, reconnect power to the ceiling grid.
11. The device must be acquired by the RF gateway (refer to "Wireless Communications" on this page.)

LOCAL / REMOTE OPERATION

Operation described in this guide assumes the CLC-1DIMFLV2EX-24V is operated in *Local* mode. The device can also operate in *Remote* mode, where button behavior is dictated by the control system program.

Local mode options (available in SIMPL Windows):

- Maintained Switch (Default): Unit will toggle on and off when the switch is toggled.
- Momentary Switch:
 - Single Tap - Both loads will toggle on and off.
 - Double Tap - Initiates a fast-full-on.
 - Hold - Initiates cycle dimming.

NOTE: If one load is on, both turn off. If both loads are off, both turn on.

WIRELESS COMMUNICATIONS

Before a CLC-1DIMFLV2EX-24V can be used in a lighting system, it must first be acquired by an infiNET EX gateway (e.g. CEN-RFGW-EX or MC3, both sold separately). Use the following procedure to join an infiNET EX network.

NOTE: A CLC-1DIMFLV2EX-24V can be acquired by only one gateway.

1. Place the gateway into *Acquire* mode from the unit (press the **ACQUIRE** button) or from Crestron Toolbox™. For details, refer to the latest version of the CEN-RFGW-EX Operations & Installation Guide (Doc. 6706) or MC3 Operations Guide (Doc. 7095) which is available from the Crestron Web site (www.crestron.com/manuals) or to the Crestron Toolbox help file.

NOTE: In an environment where multiple gateways are installed, only one gateway should be in *Acquire* mode at any time.

2. Tap the **Setup** button on the CLC-1DIMFLV2EX-24V three times rapidly, then press and hold until the **Chan. 1** and **Chan. 2** LEDs blink once (may take up to 10 seconds. Release the **Setup** Button.

NOTE: The *Acquire* process can also be initiated by a remote maintained switch (if equipped) by flipping the switch four times rapidly, or by tapping a remote momentary switch (if equipped) four times rapidly. The **Chan. 1** LED and attached load will blink (may take up to 10 seconds).

3. The **Chan. 1** LED and attached load will flash slowly while it searches for a gateway in *Acquire* mode. When the CLC-1DIMFLV2EX-24V is acquired, the **Chan. 1** LED and attached load will stay lit for five seconds and then turn off. If the CLC-1DIMFLV2EX-24V fails to acquire, the **Chan. 1** LED and attached load will flash rapidly until a button is pressed. The load will then turn off.
4. Take the gateway out of *Acquire* mode after all devices have been acquired by either pressing the **ACQUIRE** button on the CEN-RFGW-EX (or MC3) or using Crestron Toolbox. For details, refer to the latest version of the CEN-RFGW-EX Operations & Installation Guide (Doc. 6706), MC3 Operations Guide (Doc. 7095) or to the Crestron Toolbox help file.

NOTE: To leave a gateway, place the device in *Acquire* mode when there is no gateway in *Acquire* mode.

To check the communication status of the CLC-1DIMFLV2EX-24V, perform the tap-tap-tap-hold (step 2 above), but release the button after approximately two seconds. At this point, the **Chan. 1** LED will indicate communication status as described below.

LED DISPLAY	COMMUNICATIONS STATUS
Turns on (up to five seconds) when button released	Device communicating with control system.
Blinks three times	Device communicating with RF network but not defined in program.
Blinks twice	Device previously acquired to RF network but not communicating with RF network.
Blinks once	Device not acquired to RF network.

TROUBLESHOOTING

The following table provides corrective action for possible trouble situations. If further assistance is required, please contact a Crestron customer support representative.

TROUBLE	POSSIBLE CAUSE(S)	CORRECTIVE ACTION
Unit does not function.	Device is not receiving 24V power.	Verify that dimmer is properly connected to power line and neutral and the circuit breaker is closed.
	Device is in <i>Remote</i> mode.	Check the SIMPL program to determine/change the operating mode.
	Ballast failure.	Replace ballasts that do not operate.
	Device is not communicating with the gateway.	Use Crestron Toolbox to verify network connection to the device.
Improper dimming operation.	0-10V not wired correctly.	Check wiring polarity to all attached loads.

Regulatory Compliance (Continued)

Industry Canada (IC) Compliance Statement

This device complies with Industry Canada licence-exempt RSS standard(s). Operation is subject to the following two conditions: (1) this device may not cause interference, and (2) this device must accept any interference, including interference that may cause undesired operation of the device.

Le présent appareil est conforme aux CNR d'Industrie Canada applicables aux appareils radio exempts de licence. L'exploitation est autorisée aux deux conditions suivantes : (1) l'appareil ne doit pas produire de brouillage, et (2) l'utilisateur de l'appareil doit accepter tout brouillage radioélectrique subi, même si le brouillage est susceptible d'en compromettre le fonctionnement.

Under Industry Canada regulations, this radio transmitter may only operate using an antenna of a type and maximum (or lesser) gain approved for the transmitter by Industry Canada. To reduce potential radio interference to other users, the antenna type and its gain should be so chosen that the equivalent isotropically radiated power (e.i.r.p.) is not more than that necessary for successful communication.

Conformément à la réglementation d'Industrie Canada, le présent émetteur radio peut fonctionner avec une antenne d'un type et d'un gain maximal (ou inférieur) approuvé pour l'émetteur par Industrie Canada. Dans le but de réduire les risques de brouillage radioélectrique à l'intention des autres utilisateurs, il faut choisir le type d'antenne et son gain de sorte que la puissance isotrope rayonnée équivalente (p.i.r.e.) ne dépasse pas l'intensité nécessaire à l'établissement d'une communication satisfaisante.

To satisfy RF exposure requirements, this device and its antenna must operate with a separation distance of at least 20 centimeters from all persons and must not be collocated or operating in conjunction with any other antenna or transmitter.

Return and Warranty Policies

Merchandise Returns / Repair Service

1. No merchandise may be returned for credit, exchange or service without prior authorization from CRESTRON. To obtain warranty service for CRESTRON products, contact an authorized CRESTRON dealer. Only authorized CRESTRON dealers may contact the factory and request an RMA (Return Merchandise Authorization) number. Enclose a note specifying the nature of the problem, name and phone number of contact person, RMA number and return address.
2. Products may be returned for credit, exchange or service with a CRESTRON Return Merchandise Authorization (RMA) number. Authorized returns must be shipped freight prepaid to CRESTRON, 6 Volvo Drive, Rockleigh, N.J. or its authorized subsidiaries, with RMA number clearly marked on the outside of all cartons. Shipments arriving freight collect or without an RMA number shall be subject to refusal. CRESTRON reserves the right in its sole and absolute discretion to charge a 15% restocking fee plus shipping costs on any products returned with an RMA.
3. Return freight charges following repair of items under warranty shall be paid by CRESTRON, shipping by standard ground carrier. In the event repairs are found to be non-warranty, return freight costs shall be paid by the purchaser.

CRESTRON Limited Warranty

CRESTRON ELECTRONICS, Inc. warrants its products to be free from manufacturing defects in materials and workmanship under normal use for a period of three (3) years from the date of purchase from CRESTRON, with the following exceptions: disk drives and any other moving or rotating mechanical parts, pan/tilt heads and power supplies are covered for a period of one (1) year; touch screen display and overlay components are covered for 90 days; batteries and incandescent lamps are not covered.

This warranty extends to products purchased directly from CRESTRON or an authorized CRESTRON dealer. Purchasers should inquire of the dealer regarding the nature and extent of the dealer's warranty, if any.

CRESTRON shall not be liable to honor the terms of this warranty if the product has been used in any application other than that for which it was intended or if it has been subjected to misuse, accidental damage, modification or improper installation procedures. Furthermore, this warranty does not cover any product that has had the serial number altered, defaced or removed.

This warranty shall be the sole and exclusive remedy to the original purchaser. In no event shall CRESTRON be liable for incidental or consequential damages of any kind (property or economic damages inclusive) arising from the sale or use of this equipment. CRESTRON is not liable for any claim made by a third party or made by the purchaser for a third party.

CRESTRON shall, at its option, repair or replace any product found defective, without charge for parts or labor. Repaired or replaced equipment and parts supplied under this warranty shall be covered only by the unexpired portion of the warranty.

Except as expressly set forth in this warranty, CRESTRON makes no other warranties, expressed or implied, nor authorizes any other party to offer any warranty, including any implied warranties of merchantability or fitness for a particular purpose. Any implied warranties that may be imposed by law are limited to the terms of this limited warranty. This warranty statement supersedes all previous warranties.

Crestron, the Crestron logo, Crestron Toolbox and infiNET EX are trademarks or registered trademarks of Crestron Electronics, Inc. in the United States and other countries. Armstrong and Flexzone are either trademarks or registered trademarks of Armstrong World Industries, Inc. in the United States and/or other countries. EMerge Alliance and the EMerge Alliance logo are either trademarks or registered trademarks of EMerge Alliance Corporation in the United States and/or other countries. Other trademarks, registered trademarks and trade names may be used in this document to refer to either the entities claiming the marks and the names or their products. Crestron disclaims any proprietary interest in the marks and names of others.
©2011 Crestron Electronics, Inc.