

Crestron **DGE-2**
Digital Graphics Engine with HDMI[®]
and DigitalMedia[™] CAT Connectivity

Operations Guide



Regulatory Compliance

This product is Listed to applicable UL Standards and requirements by Underwriters Laboratories Inc.



As of the date of manufacture, the DGE-2 has been tested and found to comply with specifications for CE marking.



Federal Communications Commission (FCC) Compliance Statement

This device complies with part 15 of the FCC Rules. Operation is subject to the following conditions:

(1) This device may not cause harmful interference and (2) this device must accept any interference received, including interference that may cause undesired operation.

CAUTION: Changes or modifications not expressly approved by the manufacturer responsible for compliance could void the user's authority to operate the equipment.

NOTE: This equipment has been tested and found to comply with the limits for a Class B digital device, pursuant to part 15 of the FCC Rules. These limits are designed to provide reasonable protection against harmful interference in a residential installation. This equipment generates, uses and can radiate radio frequency energy and, if not installed and used in accordance with the instructions, may cause harmful interference to radio communications. However, there is no guarantee that interference will not occur in a particular installation. If this equipment does cause harmful interference to radio or television reception, which can be determined by turning the equipment off and on, the user is encouraged to try to correct the interference by one or more of the following measures:

- Reorient or relocate the receiving antenna
- Increase the separation between the equipment and receiver
- Connect the equipment into an outlet on a circuit different from that to which the receiver is connected
- Consult the dealer or an experienced radio/TV technician for help

Industry Canada (IC) Compliance Statement

CAN ICES-3(B)/NMB-3(B)

The specific patents that cover Crestron products are listed at patents.crestron.com.

Crestron, the Crestron logo, Capture HD, CresCAT, Cresnet, Crestron e-Control, Crestron Home, Crestron Studio, Crestron Toolbox, DigitalMedia, DigitalMedia 8G+, DM, DM 8G+, DMNet, Rava, Smart Graphics, SmartObjects, TouchPoint, V-Panel, and VT Pro-e are either trademarks or registered trademarks of Crestron Electronics, Inc. in the United States and/or other countries. 3M is either a trademark or registered trademark of 3M Company in the United States and/or other countries. Acrobat, Adobe, and Flash are either trademarks or registered trademarks of Adobe Systems Incorporated in the United States and/or other countries. Blu-ray Disc is either a trademark or registered trademark of the Blu-ray Disc Association (BDA) in the United States and/or other countries. Compaq is either a trademark or registered trademark of Compaq Trademark B.V. in the United States and/or other countries. Elo is either a trademark or registered trademark of Elo Touch Solutions, Inc. in the United States and/or other countries. YouTube is either a trademark or a registered trademark of Google, Inc. in the United States and/or other countries. HDMI and the HDMI logo are either trademarks or registered trademarks of HDMI Licensing LLC in the United States and/or other countries. HP is either a trademark or registered trademark of Hewlett-Packard Development Company, L.P. in the United States and/or other countries. Excel, Internet Explorer, Microsoft, PowerPoint, Windows, and Windows Media are either trademarks or registered trademarks of Microsoft Corporation in the United States and/or other countries. Netflix is either a trademark or registered trademark of Netflix, Inc. in the United States and/or other countries. Java is either a trademark or registered trademark of Oracle Corporation in the United States and/or other countries. PQ Labs is either a trademark or registered trademark of PQ Labs Inc. in the United States and/or other countries. SD and SDHC are either trademarks or registered trademarks of SD-3C, LLC in the United States and/or other countries. CyberTouch is either a trademark or registered trademark of Transparent Devices, Inc. in the United States and/or other countries. Other trademarks, registered trademarks, and trade names may be used in this document to refer to either the entities claiming the marks and names or their products. Crestron disclaims any proprietary interest in the marks and names of others. *Crestron is not responsible for errors in typography or photography.*

This document was written by the Technical Publications department at Crestron.
©2014 Crestron Electronics, Inc.

Contents

Digital Graphics Engine with HDMI and DigitalMedia CAT Connectivity: DGE-2	1
Introduction	1
Features and Functions	2
Applications.....	6
Specifications	8
Physical Description.....	12
Setup.....	18
Network Wiring.....	18
Identity Code	18
Configuring the Touch Screen.....	19
Installation.....	46
Hardware Hookup	48
Uploading and Upgrading.....	50
Establishing Communication.....	50
Programs, Projects, and Firmware.....	51
Program Checks	51
Restore.....	51
Operation – Security Infrastructure	52
Problem Solving	53
Troubleshooting.....	53
Check Network Wiring.....	54
Reference Documents.....	55
Further Inquiries	55
Future Updates	56
Return and Warranty Policies	57
Merchandise Returns / Repair Service	57
Crestron Limited Warranty.....	57
Microsoft® Windows XP Embedded End User License Agreement	58

Digital Graphics Engine with HDMI and DigitalMedia CAT Connectivity: DGE-2

Introduction

Designed for use with a Crestron® V-Panel™ HD Touch Screen Display (sold separately)¹, the DGE-2 Digital Graphics Engine (DGE) allows for a very streamlined touch screen installation by placing the bulk of the electronics out of sight at the central equipment location. Mounted in an equipment rack, the DGE-2 connects directly to the head end AV sources, switchers and control network, while the touch screen display can be up to 300 feet (91 meters) away with just a single cable between them.²

The DGE-2 delivers the ultimate touch screen experience with advanced high definition Smart Graphics™, high performance H.264 streaming video, Rava® SIP Intercom³, onboard multimedia and web browsing, audio feedback, and built-in annotation. Extensive connectivity is provided for displaying HD video from external AV and computer sources via HDMI®, DigitalMedia™, Ethernet and various analog connections. Support for HDCP ensures complete compatibility with today's digital sources.

1. The V-Panel touch screen must be equipped with a DM CAT type interface for direct connection to the DGE-2. Other V-Panel touch screens having a DM 8G+™ interface may be connected to the DGE-2 through a DM 8G+ transmitter or DigitalMedia switcher. Third-party touch screens may be connected directly to the DGE-2 via HDMI and USB or remotely via a DM CAT receiver or through a DigitalMedia system. Contact a Crestron representative for additional design assistance.
2. For DigitalMedia CAT wiring, use DM-CBL DigitalMedia cable. Maximum cable length is 300 feet (91 meters). A single DM CAT Repeater (model DM-DR) is required for lengths over 150 feet (45 meters). All wire, cables and repeaters sold separately. Refer to the DigitalMedia Design Guide (Doc. 4546) at www.crestron.com/manuals for DM® system design guidelines.
3. Supports Rava SIP Intercom, as well as legacy IP intercom and wired analog intercom. Supports push-to-talk mode only. Hands-free mode is not supported. Intercom is only supported using a V-Panel model V12 or V15. For Rava or IP Intercom, the V-Panel must connect directly to the DGE-2 via DM CAT with no repeaters or switchers in line.

Features and Functions

- Touch screen graphics and HD video processing for V-Panels
- Also compatible with third-party touch screens¹
- High definition 24-bit color graphics
- Smart Graphics support
- Onboard PC applications for Web browsing, playing digital media and viewing digital documents
- VNC viewer for remotely accessing and controlling external computers
- Native H.264 streaming video display
- Dual window full motion HD video display
- Allows touch screen viewing of HDCP protected content
- Handles video sources up to HD 1080p60
- Handles high res computer up to UXGA/WUXGA
- HDMI, RGB, composite, S-video and component video inputs
- Presentation output via HDMI or DigitalMedia
- Built-in annotation
- Customizable audio feedback
- Rava SIP intercom and phone technology²
- Crestron IP intercom and wired analog intercom capability²
- HDMI output allows direct connection to a third-party display or touch screen¹
- Audio input and output via HDMI, DM[®] and balanced line level
- Crestron Home[®] (CH) CAT5 bidirectional audio port
- USB keyboard/mouse ports
- Onscreen keyboard and mouse capability
- High speed Ethernet and Cresnet[®]
- One wire DigitalMedia connection to V-Panel or DM switcher^{1, 3}
- Two space rack mountable

1. The V-Panel touch screen must be equipped with a DM CAT type interface for direct connection to the DGE-2. Other V-Panel touch screens having a DM 8G+ interface may be connected to the DGE-2 through a DM 8G+ transmitter (DM-TX-201-C) or DigitalMedia switcher. Other touch screens may be connected directly to the DGE-2 via HDMI and USB or remotely through a DM CAT receiver (DM-RMC-100 or DM-RMC-100-1) or DigitalMedia switcher. Contact a Crestron representative for additional design assistance.
2. Supports Rava SIP Intercom, as well as legacy IP intercom and wired analog intercom. Supports push-to-talk mode only. Hands-free mode is not supported. Intercom is only supported using a V-Panel model V12 or V15. For Rava or IP Intercom, the V-Panel must connect directly to the DGE-2 via DM CAT with no repeaters or switchers in line.
3. For DigitalMedia CAT wiring, use DM-CBL DigitalMedia cable. Maximum cable length is 300 feet (91 meters). A single DM CAT Repeater (model DM-DR) is required for lengths over 150 feet (45 meters). All wire, cables and repeaters sold separately. Refer to the DigitalMedia Design Guide (Doc. 4546) for DM system design guidelines.

Smart Graphics

Crestron touch screens use Smart Graphics to deliver the ultimate user experience and the ultimate value, by enabling the creation of dynamically rich user interfaces with incredible efficiency and unparalleled functionality. Using Smart Graphics, programmers can swiftly integrate fluid gesture-driven controls, animated feedback, metadata, embedded apps and full-motion video for a deeply engaging and ultra-intuitive touch screen experience.

Crestron Smart Graphics include the following enhancements:

- Cool looking graphical buttons, sliders, knobs and gauges are intuitive and fun to use.
- Kinetic effects enhance the feeling of realism with lists and toolbars that scroll with momentum at the flick of a fingertip.
- Drag and drop objects snap into place offering an easy way to switch sources.
- Dashboard widgets personalize the touch screen with clocks, weather, news and other information.
- Customizable themes allow a completely different look and feel for every user, event or season.
- Fully developed SmartObjects™ enable sophisticated control over complex devices with minimal programming.

Embedded PC Applications

The DGE-2 provides everything needed to enjoy online music and videos, browse the Internet and even review digital documents, all on a touch screen display without a separate computer. With Microsoft® Internet Explorer® embedded, there is full access to the entire World Wide Web including sites that use Flash® or Java®. Windows Media® Player ensures broad compatibility for playing most types of digital media. Adobe® Acrobat® Reader and Microsoft® PowerPoint®, Word and Excel® document viewers complete the online experience, allowing downloading and viewing of documents and presentations.

In addition, VNC Viewer support delivers enhanced cross-platform interaction with computers over the network or Internet, allowing remote access and control of desktop applications to unleash a host of possibilities for system integration and multimedia presentation.

HD Streaming Video

High definition streaming video capability makes it possible to view security cameras and other video sources over the network right on the touch screen. Native support for H.264 and MJPEG formats allow the DGE-2 to display live streaming video from an IP camera, a streaming server (Crestron CEN-NVS200¹ or similar), a DigitalMedia switcher, or a Capture HD® system. Also, through its embedded web browser and media player, it supports a wide variety of other streaming and downloadable video formats, enabling access to all kinds of content from media servers and websites like YouTube® and Netflix®².

1. Item(s) sold separately.
2. Accessing Netflix content requires an active Netflix account. Refer to www.netflix.com for details.

HDMI and Analog Video

In addition to handling streaming video, the DGE-2 also provides extensive connectivity for more conventional types of sources including HDMI. The DGE-2 can simultaneously generate two fully scalable, full motion video windows, each supporting SD or HD video and high resolution computer signals from external digital and analog sources.

Input connections include two HDMI, two RGB and two multi-format analog video. The HDMI inputs support digital HD sources including HDMI, DVI and DisplayPort Multimode¹. The RGB inputs handle high resolution analog VGA computer sources and the multi-format video inputs accept analog composite, S-video and component HD video sources. External audio signals are handled by the HDMI inputs and by a single analog line input.

HDCP Support

Industry leading support for HDCP (High-bandwidth Digital Content Protection) ensures seamless compatibility with content protected DVD, Blu-ray Disc™, digital HDTV and multimedia computer sources.

Rave SIP Intercom

Rava SIP Intercom² technology enables VoIP communication between any two Rava-enabled Crestron touch screens. Rava works over Ethernet, supporting 2-way intercom, video intercom³, and paging without requiring any special wiring. VoIP phone capability is also possible through integration of an SIP-compatible IP phone system or SIP server.

The DGE-2 also supports legacy Crestron IP Intercom and Crestron Home® (CH) CAT5 wired intercom. Crestron IP Intercom enables compatibility with the C2N-IADS30X24 (sold separately) or other CH CAT5 switchers and processors.

Keyboard/Mouse Options

On-screen keyboard and mouse capabilities enable complete control of the DGE-2's embedded web browser and other applications and can also be used to control computers running TouchPoint® Virtual Mouse & Keyboard Software (VMK-WIN). USB ports are also provided on the front and rear of the DGE-2 and on some V-Panel displays (sold separately), allowing for the connection of a physical keyboard and mouse.

Real Time Annotation

Whether conducting a high level boardroom meeting, training seminar or watching sports in a home theater, annotation helps put the fine point on any presentation. Native to the DGE-2, annotation provides the ability to illustrate thoughts on the fly, allowing drawing and writing over high definition video and computer images and sketching out of ideas on a whiteboard screen, without leaving the podium or a favorite chair while other viewers watch on the big screen.

1. HDMI requires an appropriate adapter or interface cable to accommodate a DVI or DisplayPort Multimode signal. CBL-HD-DVI interface cables available separately.
2. Supports Rava SIP Intercom, as well as legacy IP intercom and wired analog intercom. Supports push-to-talk mode only. Hands-free mode is not supported. Intercom is only supported using a V-Panel model V12 or V15. For Rava or IP Intercom, the V-Panel must connect directly to the DGE-2 via DM CAT with no repeaters or switchers in line.
3. H.264 compatible IP camera required.

Remote Annotation

Remote annotation capability allows multiple touch screen users to draw with their fingertips over the same video image or whiteboard screen, enabling enhanced interaction between several participants in a courtroom, classroom or council chamber.

Presentation Output

Through its HDMI output or via a DigitalMedia system, the DGE-2 allows the touch screen image to be sent to additional display devices, allowing videos, PowerPoint presentations, annotation and other on-screen media to be shared with a live audience.

DigitalMedia

DigitalMedia (DM) connectivity opens up new ways to configure a touch screen control system. For instance, using a DM switcher such as the DM-MD8X8 (sold separately), multiple touch screens can be connected to a single DGE-2, providing a simple, cost effective way for multiple participants to view and control the same graphical interface. DigitalMedia also provides a versatile means for distributing touch screen content to a larger audience, routing the DGE-2's DM output to feed additional video displays and sound equipment.

V-Panel Connectivity

The DGE-2 features a DM CAT type output, supporting the direct connection to V-Panel touch screen models V12 and V15 (both sold separately). It can also connect to any DM switcher or receiver equipped with a DM CAT input. A single DigitalMedia cable carries all video, audio, Ethernet, USB, control and power signals up to 300 feet (91 meters) between the V-Panel and DGE-2.^{1,2}

The DGE-2 is also compatible with the V24R-C series of V-Panel 24" HD Touch Screen Displays (sold separately). A DigitalMedia 8G+™ Transmitter (DM-TX-201-C or equivalent, sold separately) provides the interface between the DGE-2's HDMI output and the DM 8G+™ input of a V24R-C. Alternately, when feeding a V24R-C display through a DM switcher, the DM 8G+ transmitter is not required.

The DGE-2 is also compatible with the TSD-2020 V-Panel 20" HD Touch Screen Display (sold separately). The TSD-2020 can be connected directly to the DGE-2 via HDMI and USB, or through a DigitalMedia CAT Receiver (DM-RMC-100 or DM-RMC-100-1, both sold separately) for longer wire runs.

1. The V-Panel touch screen must be equipped with a DM CAT type interface for direct connection to the DGE-2. Other V-Panel touch screens having a DM 8G+ interface may be connected to the DGE-2 through a DM 8G+ transmitter (DM-TX-201-C) or DigitalMedia switcher. Other touch screens may be connected directly to the DGE-2 via HDMI and USB or remotely through a DM CAT receiver (DM-RMC-100 or DM-RMC-100-1) or DigitalMedia switcher. Contact a Crestron representative for additional design assistance.
2. For DigitalMedia CAT wiring, use DM-CBL DigitalMedia cable. Maximum cable length is 300 feet (91 meters). A single DM CAT Repeater (model DM-DR) is required for lengths over 150 feet (45 meters). All wire, cables and repeaters sold separately. Refer to the DigitalMedia Design Guide (Doc. 4546) for DM system design guidelines.

Applications

The following diagram illustrates use of a DGE-2 with either a V12, V15 or V24R-C V-Panel touch screen display.

When used with a V12 or V15, the DGE-2 connects to the V-Panel via DM-CBL cable.

Using a DGE-2 with a V24R-C requires the use of a DigitalMedia 8G+ Transmitter (DM-TX-201, C or equivalent, sold separately). The DM-TX-201-C connects to the V24R-C via DM-CBL-8G. Alternatively, when feeding a V24R-C display through a DM switcher, the DM 8G+ transmitter is not required.

DGE-2 & V-Panel Compatibility

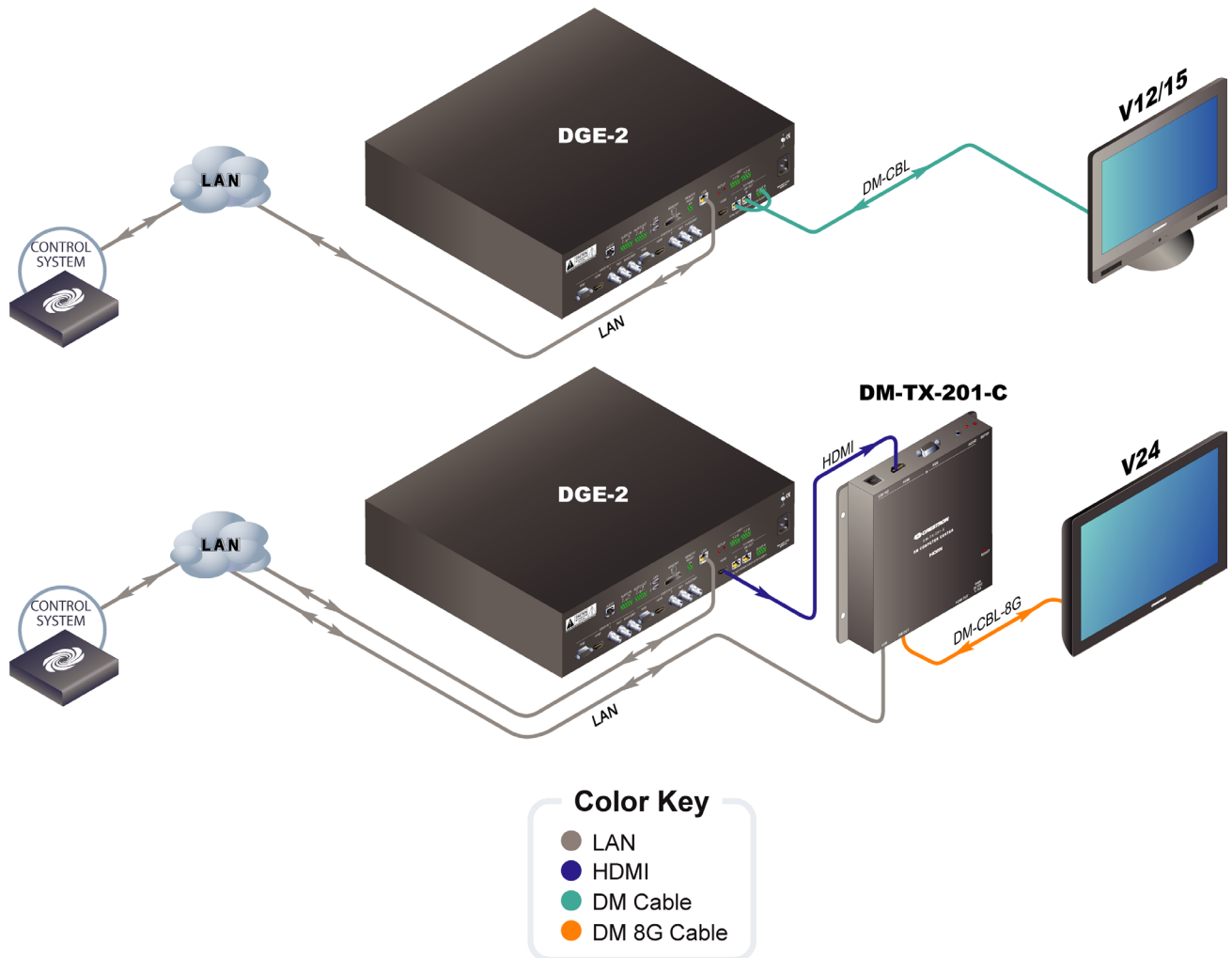

The following diagram shows a DGE-2 in a typical application.

DGE-2 in a Typical Application

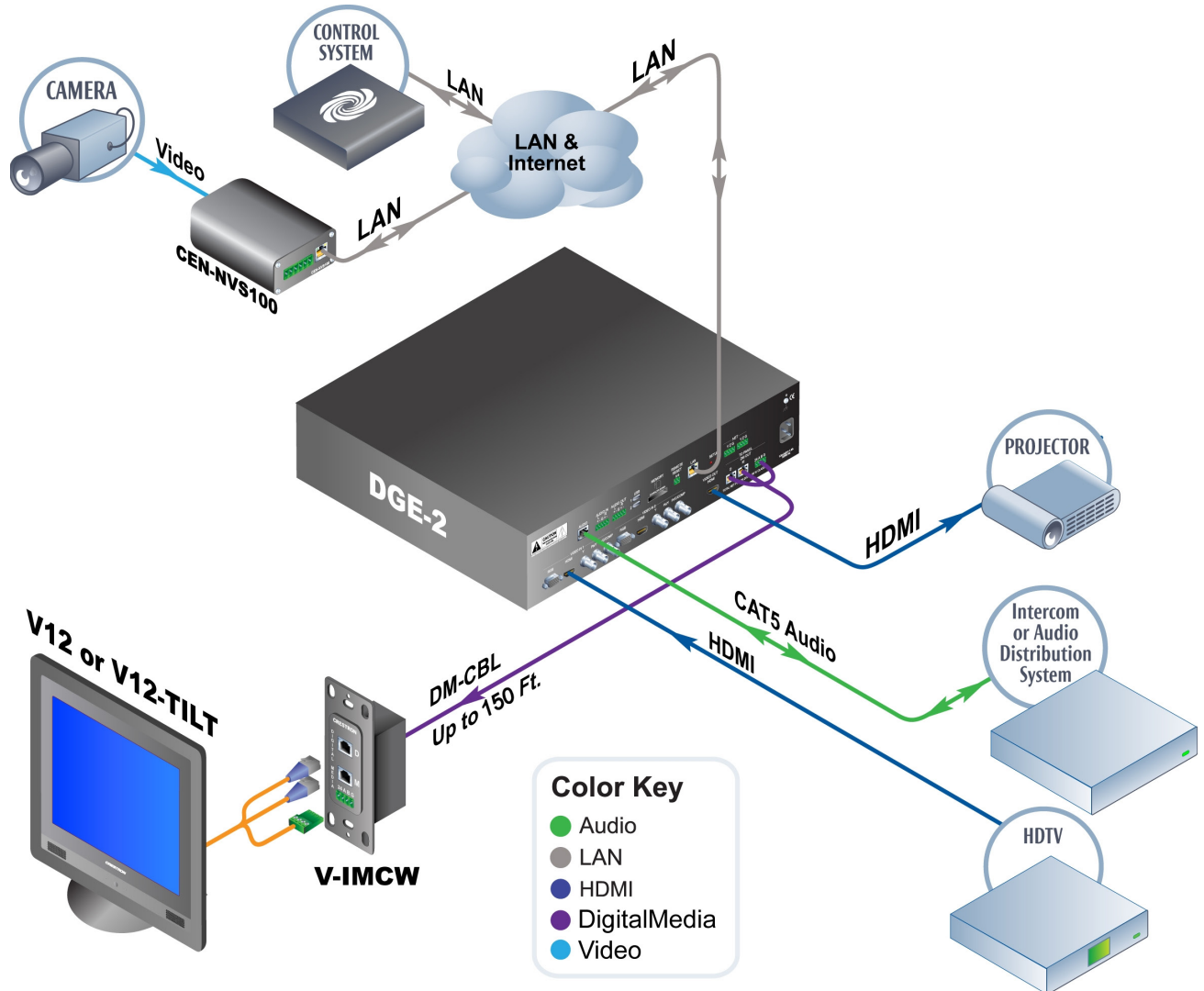

Specifications

Specifications for the DGE-2 are listed in the following table.

DGE-2 Specifications

SPECIFICATION	DETAILS
Graphics Engine	Supports Smart Graphics or "traditional" GUI projects
Embedded PC Applications ¹	Microsoft Internet Explorer 7 with Adobe Flash plug-in and Java Runtime plug-in, Windows Media Player, Remote Desktop, VNC Viewer, Adobe Acrobat Reader, WordPad, MS Word Viewer 2007, Excel Viewer 2007, PowerPoint Viewer 2007
Languages	Arabic, Chinese Simplified, Chinese Traditional, Croatian, Czech, Danish, Dutch, English, Estonian, Finnish, French, German, Greek, Hebrew, Hungarian, Icelandic, Indonesian, Italian, Japanese, Korean, Latvian, Lithuanian, Norwegian, Polish, Portuguese, Romanian, Russian, Serbian, Slovak, Slovenian, Spanish, Swedish, Turkish
Memory	
SDRAM	2 GB
Flash	4 GB
Memory Card	Supports SD™ and SDHC™ cards up to 32 GB (not included)
Maximum Project Size	240 MB
Communications	
Ethernet	10/100 Mbps, auto-switching, auto-negotiating, auto-discovery, full/half duplex, DHCP, for control and console
Cresnet®	Cresnet slave mode for control and console
USB	USB 2.0 host, supports USB HID (Human Interface Device) class devices, touch screens and USB flash drives
DigitalMedia	DM CAT, DMNet®, HDCP, EDID, 100 Mbps Ethernet
HDMI	HDCP, EDID, CEC
Touch Screen Device Support ²	In addition to Crestron V-Panels, compatible touch screen products are offered by (but not limited to) the following manufacturers: 3M™ Touch Systems CyberTouch® Elo Touch Solutions® HP® Compaq® PQ Labs®

(Continued on following page)

DGE-2 Specifications (Continued)

SPECIFICATION	DETAILS
Video	
Input Signal Types	HDMI, DVI ³ , DisplayPort Multimode ³ , RGB, component (YPbPr), S-video (Y/C), composite
Output Signal Type	DM CAT, HDMI, DVI ³
Formats	HDMI, DVI, HDCP content protection support, computer up to UXGA/WUXGA, HDTV up to 1080p60, NTSC or PAL
Input Resolutions	
HDMI, Progressive	640 x 480 @ 60 Hz 720 x 480 @ 60 Hz (480p) 720 x 576 @ 50 Hz (576p) 800 x 600 @ 60 Hz 848 x 480 @ 60 Hz 852 x 480 @ 60 Hz 854 x 480 @ 60 Hz 1024 x 768 @ 60 Hz 1024 x 852 @ 60 Hz 1024 x 1024 @ 60 Hz 1280 x 720 @ 50 Hz (720p50) 1280 x 720 @ 60 Hz (720p60) 1280 x 768 @ 60 Hz 1280 x 800 @ 60 Hz 1280 x 960 @ 60 Hz 1280 x 1024 @ 60 Hz 1360 x 768 @ 60 Hz 1365 x 1024 @ 60 Hz 1366 x 768 @ 60 Hz 1400 x 1050 @ 60 Hz 1440 x 900 @ 60 Hz 1600 x 900 @ 60 Hz 1600 x 1200 @ 60 Hz 1680 x 1050 @ 60 Hz 1920 x 1080 @ 24 Hz (1080p24) 1920 x 1080 @ 25 Hz (1080p25) 1920 x 1080 @ 50 Hz (1080p50) 1920 x 1080 @ 60 Hz (1080p60) 1920 x 1200 @ 60 Hz
HDMI, Interlaced	720 x 480 @ 30 Hz (480i) 720 x 576 @ 25 Hz (576i) 1920 x 1080 @ 25 Hz (1080i25) 1920 x 1080 @ 30 Hz (1080i30)

(Continued on following page)

DGE-2 Specifications (Continued)

SPECIFICATION	DETAILS
Input Resolutions (Continued)	
RGB	640 x 480 @ 60 Hz 720 x 480 @ 60 Hz (480p) 720 x 576 @ 50 Hz (576p) 800 x 600 @ 60 Hz 1024 x 768 @ 60 Hz 1280 x 720 @ 50 Hz (720p50) 1280 x 720 @ 60 Hz (720p60) 1280 x 768 @ 60 Hz 1280 x 800 @ 60 Hz 1280 x 960 @ 60 Hz 1280 x 1024 @ 60 Hz 1360 x 768 @ 60 Hz 1400 x 1050 @ 60 Hz 1440 x 900 @ 60 Hz 1600 x 1200 @ 60 Hz 1920 x 1080 @ 50 Hz (1080p50) 1920 x 1080 @ 60 Hz (1080p60) 1920 x 1200 @ 60 Hz
Component	480i, 576i, 480p, 576p, 720p50, 720p60, 1080p24, 1080i25 (1125 lines), 1080i30, 1080p30, 1080p50 (1125 lines), 1080p60
Composite and S-video	480i, 576i
Output Resolutions, HDMI & DM	800 x 600 @ 60 Hz 1024 x 768 @ 60 Hz 1280 x 720 @ 50 Hz (720p50) 1280 x 720 @ 60 Hz (720p60) 1280 x 768 @ 60 Hz 1280 x 960 @ 60 Hz 1280 x 1024 @ 60 Hz 1600 x 1200 @ 60 Hz 1920 x 1080 @ 50 Hz (1080p50) 1920 x 1080 @ 60 Hz (1080p60) 1920 x 1200 @ 60 Hz
Color Depth	24-bit, 16.7 million colors
Streaming/File Formats	H.264 (MPEG-4 part 10 AVC), MJPEG, plus all formats supported by Windows Media Player
Audio	
Features	Internal volume control and audio mixer, Rava SIP Intercom ⁴ , Crestron IP Intercom ⁴
Input Signal Types	HDMI, DisplayPort Multimode ³ , analog stereo, Crestron Home (CH) CAT5
Output Signal Types	DM CAT, HDMI, analog line level, CH CAT5
Formats, DM & HDMI	2-channel PCM
Formats, Analog	Stereo 2-channel
A-D/D-A Conversion	24-bit, 48 kHz
Streaming/File Formats	As supported by Windows Media Player
Audio Feedback	MP3 using Smart Graphics, WAV using "traditional" graphics

(Continued on following page)

DGE-2 Specifications (Continued)

SPECIFICATION	DETAILS
Power Requirements	
Main Power	1.8 amps @ 100-240 Vac, 50/60 Hz
Power Consumption	120 watts maximum
Cresnet Power Usage	Does not draw Cresnet power
Available DMNet Power	50 watts (2.08 amps @ 24 Vdc)
Default Net ID	03
Environmental	
Temperature	32° to 113°F (0° to 45°C)
Humidity	10% to 90% RH (non-condensing)
Heat Dissipation	410 Btu/h
Enclosure	
Chassis	Metal, black finish, vented sides, fan cooled
Faceplate	Metal, black finish, polycarbonate label overlay
Mounting	Freestanding or 2U 19-inch rack mountable (adhesive feet and rack ears included)
Dimensions	
Height	3.56 in (91 mm) 3.47 in (89 mm) without feet
Width	17.03 in (433 mm) 19.00 in (483 mm) with ears
Depth	12.19 in (310 mm)
Weight	8.6 lb (3.9 kg)
Available Accessories	
CBL Series	Crestron Certified Interface Cables
CEN-NVS200	Network Video Streamer
CRESNET	Cresnet Control Cable
DM-CBL	DigitalMedia Cable
DM-CONN	DigitalMedia Cable Connector
DM-DR	DigitalMedia CAT Repeater
DM-TX-201-C ⁵	DigitalMedia 8G+ Transmitter
TSD-2020 ⁶	V-Panel 20" HD Touch Screen Display
V12	V-Panel 12" HD Touch Screen Display
V15	V-Panel 15" HD Touch Screen Display
V24R-C ⁷	V-Panel 24" HD Touch Screen Display
VMK-WIN	TouchPoint Virtual Mouse & Keyboard Software for Windows [®]

1. Consult Crestron for a current list of compatible devices and embedded applications. To ensure reliable performance, new device drivers and applications are available only from Crestron through firmware updates.
2. Please contact the respective manufacturer for further details. For latest touch screen and mouse device support information, refer to Crestron True Blue Online Help Answer ID 4666 or contact Crestron True Blue Support at www.crestron.com/true_blue_support.
3. HDMI requires an appropriate adapter or interface cable to accommodate a DVI or DisplayPort Multimode signal. CBL-HD-DVI interface cables available separately.
4. Supports Rava SIP Intercom, as well as legacy IP intercom and wired analog intercom. Supports push-to-talk mode only. Hands-free mode is not supported. Intercom is only supported using a

- V-Panel model V12 or V15. For Rava or IP Intercom, the V-Panel must connect directly to the DGE-2 via DM CAT with no repeaters or switchers in line.
5. Required for use with V24R-C displays.
 6. May require a DM-RMC-100 or DM-RMC-100-1.
 7. Requires a DM-TX-201-C or equivalent (sold separately).

Physical Description

This section provides information on the connections, controls and indicators available on the DGE-2.

DGE-2 Physical View (Front View)



DGE-2 Physical View (Rear View)

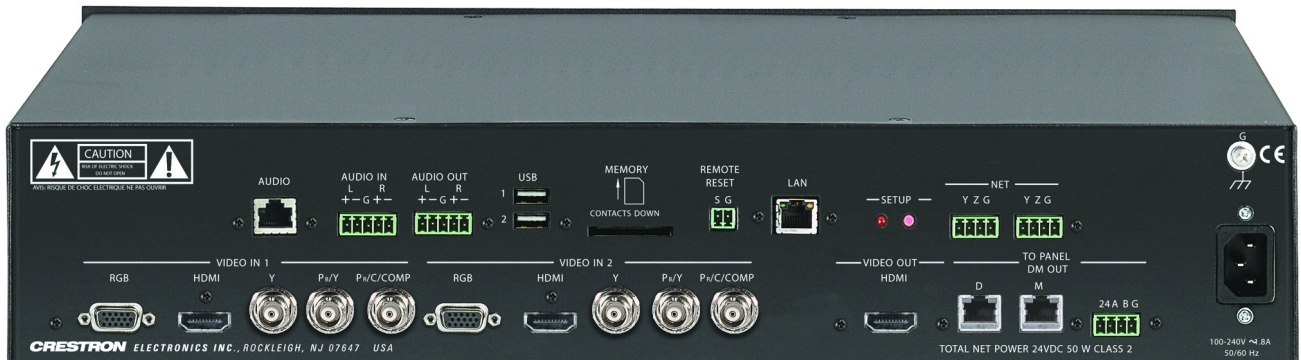

DGE-2 Overall Dimensions (Front View)



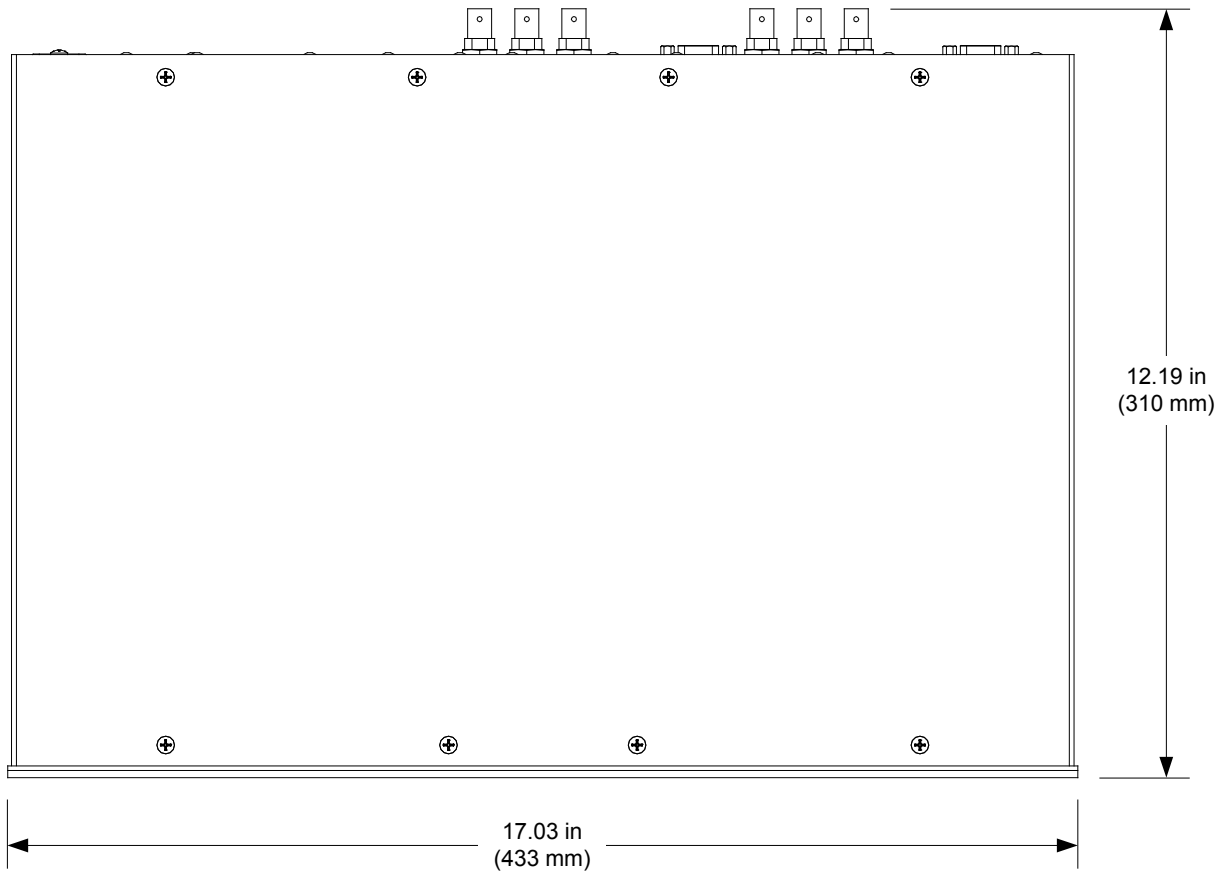

DGE-2 Overall Dimensions (Top View)

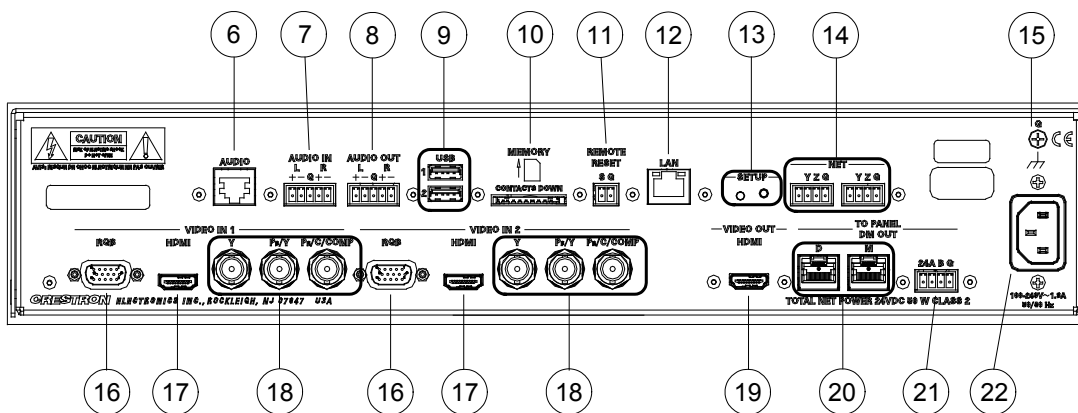

DGE-2 Overall Dimensions (Rear View)



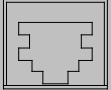
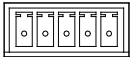





Connectors, Controls, and Indicators

#	CONNECTORS ¹ , CONTROLS, AND INDICATORS	DESCRIPTION
1	USB (front) 	(1) USB Type A female; USB 2.0 host port for connection of a USB HID-compliant mouse/keyboard, touch screen or USB flash drive
2	PWR LED	(1) Green LED, indicates ac line power is connected
3	NET LED	(1) Amber LED, indicates communication with Cresnet system
4	RESET	(1) Recessed miniature push button, resets the DGE
5	DM LINK LED	(1) Green LED, indicates connection to a V-Panel or other DM device
6	AUDIO 	(1) 8-pin RJ-45 female, shielded; Bidirectional CAT5 balanced stereo audio port; Paralleled to AUDIO IN and AUDIO OUT connectors; Connects to any other Crestron “CH” CAT5 balanced audio port via CresCAT [®] cable (sold separately); Maximum length: 1000 feet (~305 meters)
7	AUDIO IN L R +- G +- 	(1) 5-pin 3.5 mm detachable terminal block; Balanced/unbalanced stereo line level input; Input impedance: 20 kΩ balanced, 10 kΩ unbalanced; Maximum input level: 4 Vrms balanced, 2 Vrms unbalanced
8	AUDIO OUT L R +- G +- 	(1) 5-pin 3.5 mm detachable terminal block; Balanced/unbalanced stereo line level output; Output impedance: 200 Ω balanced, 100 Ω unbalanced; Maximum output level: 4 Vrms balanced, 2 Vrms unbalanced

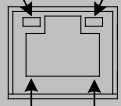

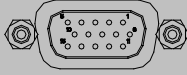
(Continued on following page)

Connectors, Controls, and Indicators (Continued)

#	CONNECTORS ¹ , CONTROLS, AND INDICATORS	DESCRIPTION																				
9	<p>USB (1 – 2)</p> 	(2) USB Type A female; USB 2.0 host ports for connection of a USB HID-compliant mouse/keyboard, touch screen or USB flash drives																				
10	<p>MEMORY</p> 	(1) SD memory card slot; Accepts one SD or SDHC card up to 32 GB for memory expansion																				
11	<p>REMOTE RESET</p> <p>S G</p> 	(1) 2-pin 3.5 mm detachable terminal block; Contact closure sensing input for hardware reset																				
12	<p>LAN</p> <p>Green LED Yellow LED</p>  <p>Pin 8 Pin 1</p> <table border="1" data-bbox="971 804 1433 951"> <thead> <tr> <th>PIN</th> <th>SIGNAL</th> <th>PIN</th> <th>SIGNAL</th> </tr> </thead> <tbody> <tr> <td>1</td> <td>TX +</td> <td>5</td> <td>N/C</td> </tr> <tr> <td>2</td> <td>TX -</td> <td>6</td> <td>RX -</td> </tr> <tr> <td>3</td> <td>RX +</td> <td>7</td> <td>N/C</td> </tr> <tr> <td>4</td> <td>N/C</td> <td>8</td> <td>N/C</td> </tr> </tbody> </table>	PIN	SIGNAL	PIN	SIGNAL	1	TX +	5	N/C	2	TX -	6	RX -	3	RX +	7	N/C	4	N/C	8	N/C	<p>(1) 8-pin RJ-45 with two LED indicators; 10BASE-T/100BASE-TX Ethernet port; Green LED indicates Ethernet link status; Amber LED indicates Ethernet activity</p>
PIN	SIGNAL	PIN	SIGNAL																			
1	TX +	5	N/C																			
2	TX -	6	RX -																			
3	RX +	7	N/C																			
4	N/C	8	N/C																			
13	<p>SETUP Button and LED</p>	(1) Recessed miniature push button and red LED for Ethernet auto-discovery and TSID																				
14	<p>NET</p> <p>Y Z G</p> 	<p>(2) 4-pin 3.5 mm detachable terminal blocks; Cresnet slave ports, paralleled;</p> <p>Y: Data Z: Data G: Ground</p>																				
15	<p>G</p> 	(1) 6-32 screw, chassis ground lug																				
16	<p>VIDEO IN (1 – 2) RGB</p> 	<p>(2) DB15HD female, RGB (VGA) video inputs;</p> <p>Formats: RGBHV, RGBS, RG_SB;</p> <p>Input levels: 0.5 to 1.5 Vp-p with built-in DC restoration;</p> <p>Input impedance: 75 Ω;</p> <p>Sync input type: Autodetect RGBHV, RGBS, RG_SB;</p> <p>Sync input level: 3 to 5 Vp-p;</p> <p>Sync input impedance: 1 kΩ</p>																				
17	<p>VIDEO IN (1 – 2) HDMI</p> 	<p>(2) 19-pin Type A HDMI female; HDMI digital video/audio inputs; Also supports DVI and DisplayPort Multimode²</p>																				

(Continued on following page)

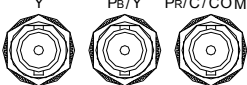
Connectors, Controls, and Indicators (Continued)

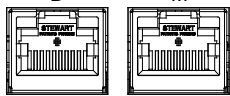
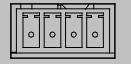
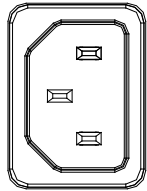
#	CONNECTORS ¹ , CONTROLS, AND INDICATORS	DESCRIPTION
18	VIDEO IN (1 – 2) Y Pb/Y Pr/C/COMP 	(2) Auto-sensing, multi-format analog video inputs, each comprised of (3) BNC female; Signal types: component (YPbPr), S-video (Y/C) or composite; Input level: 1 Vp-p nominal; Input impedance: 75 Ω nominal
19	VIDEO OUT HDMI 	(1) 19-pin Type A HDMI female; HDMI digital video/audio output; Also supports DVI ² Carries same audio and video signals as DM OUT
20	TO PANEL DM OUT, D & M ³ 	(1) DM CAT output comprised of (2) 8-pin RJ-45 female, shielded; Connects to DM CAT input of a V-Panel display via DB-CBL cable ^{4,5}
21	TO PANEL DM OUT, 24 A B G ^{6,7,8} 	(1) 4-pin 3.5 mm detachable terminal block, DMNet port; Connects to DMNet port of a V-Panel display via DB-CBL cable ^{4,5}
22	100-240V ~1.8A 50/60 Hz 	(1) IEC C14 male chassis plug; Mates with detachable power cord, included

- Interface connectors for **AUDIO IN**, **AUDIO OUT**, **24 A B G**, **REMOTE RESET** and **NET** ports are provided with the unit.
- HDMI requires an appropriate adapter or interface cable to accommodate a DVI or DisplayPort Multimode signal. CBL-HD-DVI interface cables available separately.
- The **DM OUT** port consists of two separate RJ-45 connectors labeled **D** and **M**. The **D** port carries HDMI signal. The **M** port carries data. Refer to the following table for the connector pinouts.

D and M Ports

			
PIN #	WIRE COLOR	PIN #	WIRE COLOR
1	Orange/White	5	Blue/White
2	Orange	6	Green
3	Green/White	7	Brown/White
4	Blue	8	Brown

- The V-Panel touch screen must be equipped with a DM CAT type interface for direct connection to the DGE-2. Other V-Panel touch screens having a DM 8G+ interface may be connected to the DGE-2 through a DM 8G+ transmitter (DM-TX-201-C) or DigitalMedia switcher. Other touch screens may be connected directly to the DGE-2 via HDMI and USB or remotely through a DM CAT receiver (DM-RMC-100 or DM-RMC-100-1) or DigitalMedia switcher. Contact a Crestron representative for additional design assistance.

5. For DigitalMedia CAT wiring, use DM-CBL DigitalMedia cable. Maximum cable length is 300 feet (91 meters). A single DM CAT Repeater (model DM-DR) is required for lengths over 150 feet (45 meters). All wire, cables and repeaters sold separately. Refer to the DigitalMedia Design Guide (Doc. 4546) for DM system design guidelines.
6. DMNet wiring is not compatible with Cresnet wiring. DMNet wiring cannot be daisy chained.
7. Refer to the following table for the **24 A B G** connector pinouts.

24 A B G Port

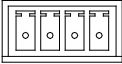
<div style="display: flex; justify-content: center; align-items: center;"> <div style="margin-right: 10px;">24 A B G</div>  </div>			
PIN #	SIGNAL	DESCRIPTION	WIRE COLOR
24	24V DC	DC Power	Red
A	DMNet+	DMNet	White
B	DMNet-	DMNet	Blue
G	Ground	DC Ground	Black

8. If a DM Switcher or other DM device supplying power is connected to the DGE-2, the wire to the **24** pin between the DM device and the DGE-2 must be disconnected. The wires to the **A**, **B** and **G** pins must remain connected.

Setup

Network Wiring

When wiring the Cresnet[®] network, consider the following:

NOTE: DMNet[®] wiring and Cresnet wiring are not compatible.

- Use Crestron Certified Wire.
- Use Crestron power supplies for Crestron equipment.
- Provide sufficient power to the system.
- For DigitalMedia CAT wiring, use DM-CBL DigitalMedia cable. Maximum cable length is 300 feet (91 meters). A single DM CAT repeater (model DM-DR) is required for lengths over 150 feet (45 meters). All wire, cables and repeaters sold separately. Refer to the DigitalMedia Design Guide (Doc. 4546) for DM system design guidelines.

CAUTION: Insufficient power can lead to unpredictable results or damage to the equipment. Use the Crestron Power Calculator to help calculate how much power is needed for the system (www.crestron.com/calculators).

For Cresnet networks with 20 or more devices, use a Cresnet Hub/Repeater (CNXHUB) to maintain signal quality.

For more details, refer to “Check Network Wiring” on page 54.

The DGE-2 can also use high-speed Ethernet for communications between the device and a control system, computer, digital media server and other IP-based devices.

For general information on connecting Ethernet devices in a Crestron system, refer to the latest version of the Crestron e-Control[®] Reference Guide (Doc. 6052) at www.crestron.com/manuals.

Identity Code

NOTE: The latest software can be downloaded at www.crestron.com/software.

Net ID

The Net ID of the DGE-2 has been factory set to **03**. The Net IDs of multiple DGE-2 devices in the same system must be unique. The Net ID is set using the internal setup menu (refer to “Cresnet” on page 23). Net ID may also be set from a personal computer (PC) via Crestron Toolbox[™] (refer to “Establishing Communication” on page 50).

When setting the Net ID, consider the following:

- The Net ID of each unit must match an ID code specified in the Crestron Studio[™] or SIMPL Windows program.
- Each network device must have a unique Net ID.

For more details, refer to the Crestron Toolbox help file.

IP ID

The IP ID is set within the DGE-2's IP table using Crestron Toolbox. For information on setting an IP table, refer to the Crestron Toolbox help file. The IP IDs of multiple DGE-2 devices in the same system must be unique.

When setting the IP ID, consider the following:

- The IP ID of each unit must match an IP ID specified in the Crestron Studio™ or SIMPL Windows program.
- Each device using IP to communicate with a control system must have a unique IP ID.

Configuring the Touch Screen

NOTE: The only connection required to configure the touch screen is power, supplied from the DGE-2. Refer to “Hardware Hookup” on page 48 for details.

The DGE-2 and V-Panel are configured from the setup menu.

NOTE: If no project has been loaded or if an invalid project has been loaded, the touch screen displays an error message and defaults to the setup menu screen.

If a project is running, the setup menu can be accessed using one of three methods:

1. Touch the screen during boot up when the “Preparing to Load Project” message is displayed. Maintain touch until after the countdown, when the message changes to “Loading Setup Screen”.
2. If the project has a button defined for this purpose, touching the button provides entry into the setup menu.
3. Crestron Toolbox can be also used to enter the setup menu:
 - a. Establish communication with the touch screen (refer to “Establishing Communication” on page 50 for details).
 - b. Right-click on the device and select **Functions > Setup Mode...**

“Setup/Calibrate” Window

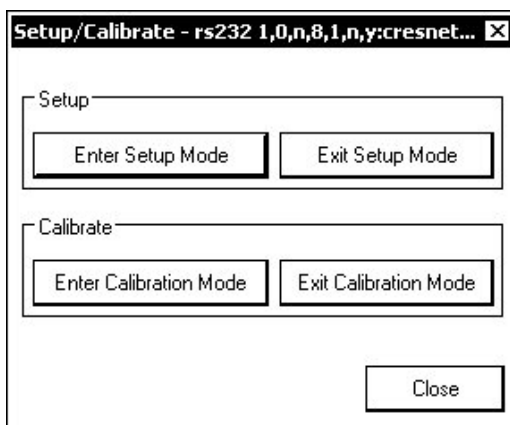

- c. Select **Enter Setup Mode**. The setup menu is displayed as shown in the following illustration.

NOTE: Select **Exit Setup Mode** to exit the setup menu.

DGE-2/V-Panel Setup Menu

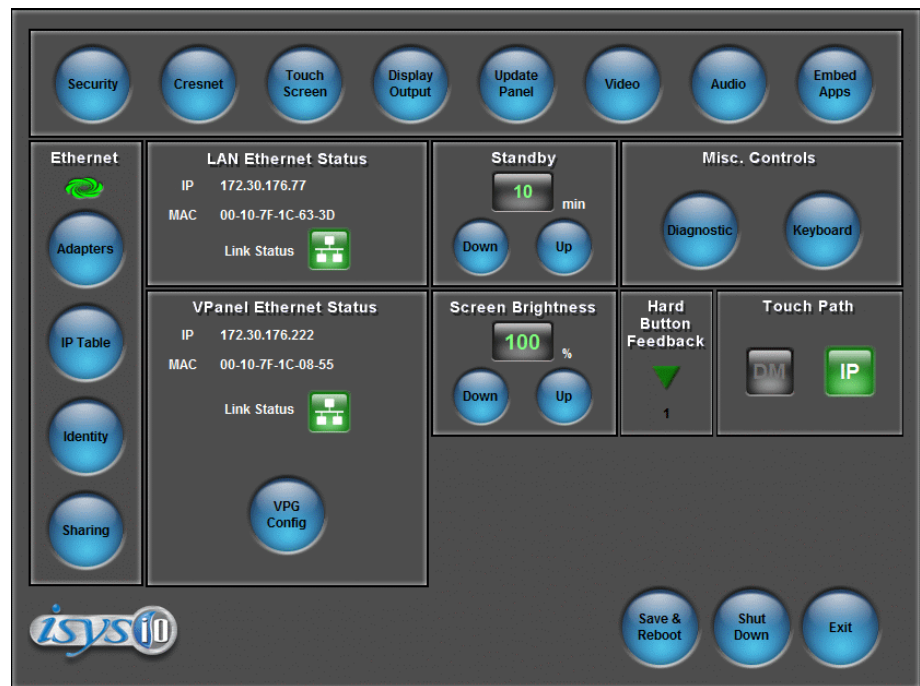

The setup menu provides access to all basic functions and parameters. It is divided into **Setup**, **Ethernet**, **LAN Ethernet Status**, **Standby**, **Misc. Controls**, **VPanel Ethernet Status**, **Screen Brightness**, **Hard Button Feedback** and **Touch Path** sections. There are also buttons for **Save & Reboot**, **Shut Down** and **Exit**.

NOTE: VPanel Ethernet status, screen brightness, hard button feedback and touch path are displayed unless there is a V-Panel connected directly to the DGE-2 **DM OUT** ports.

NOTE: To allow the touch screen to upload projects, standby is disabled until approximately five minutes after the project is loaded.

To exit the setup menu and return to the program, touch **Exit**, located at the bottom of the setup menu. To save any changes and reboot the touch screen, touch **Save & Reboot**, located at the bottom of the setup menu. Use the **Shut Down** button to turn off the touch screen.

Setup Menu Details

The setup menu allows configuration of the touch screen's settings for security, Cresnet ID, touch screen calibration, runtime project, video, audio, embedded applications and diagnostics. The setup menu also has a button that toggles the on-screen keyboard on and off.

Security

The **Security** button opens the **Security Setup** window, which allows the user to change the username and password of the system account, setup and close network connections, setup a proxy server, close network connections and clear Internet browser temporary files, history and cookies.

NOTE: To use the on-screen keyboard for security settings, touch **Keyboard** on the startup menu before touching **Security**.

Security Setup Window

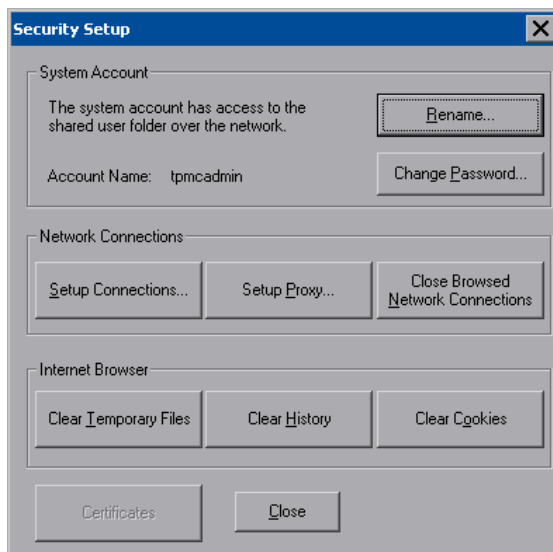

Touch **Setup Connections** to open the **Network Connections** window. This window is used to map to a network drive. A mapped network drive permits easy access to embedded application files (Word, Excel, PowerPoint, MediaMarker, etc.) and provides a location to save files. To further customize the installation, network drives containing compiled touch screen project files can also be mapped.

Network Connections Window

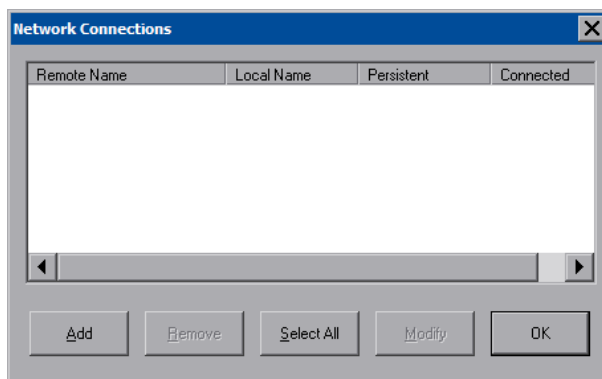

To add a new network connection, touch **Add**.

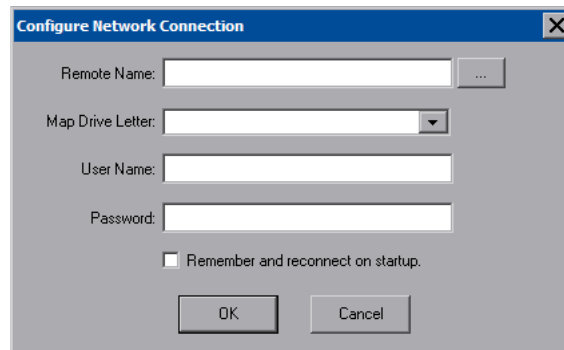
Configure Network Connection Window

To add a network drive, perform the following procedure:

1. Touch ... to browse for the new network connection. If the remote shareable folder name does not appear on the list, it can be entered manually in the *Remote Name* field, using the following format:
`\\Remote host name\Shareable folder name`
2. Map this connection by selecting a drive letter from the *Map Drive Letter* drop box.
3. Enter a user name and password.
4. Touch the **Remember and reconnect on startup** checkbox if so desired.
5. Touch **OK** to enable the new network connection and return to the **Network Connections** window.

Once all changes to network connections have been completed, touch **OK** to return to the **Security Setup** window.

Touch **Setup Proxy** to open the **Setup Proxy** window. This window is used to point to a proxy server for Internet access. A proxy server acts as an intermediary between an internal network (intranet) and the Internet, retrieving files from remote web servers.

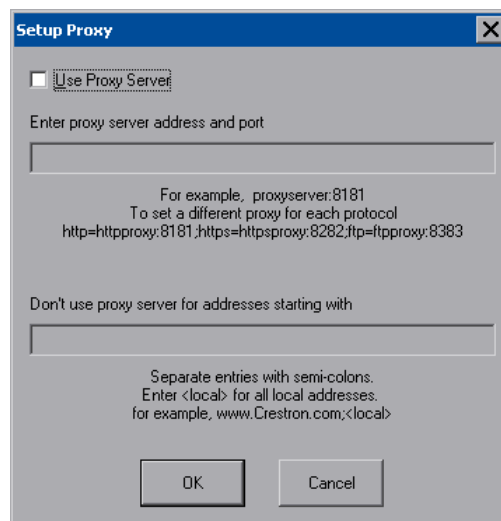
Setup Proxy Window

To setup a proxy server, select **Use Proxy Server**.

1. Enter the IP address or name of the proxy server.
2. If desired, specify addresses that should not use the proxy server (i.e., intranet addresses).

Touch **OK** to enable the proxy server connection and return to the **Security Setup** window. Then touch **Close** to return to the setup menu.

Cresnet

The **Cresnet** button opens the **Cresnet Setup** window, which allows enabling or disabling Cresnet and permits changing the Cresnet ID.

Cresnet Setup Window

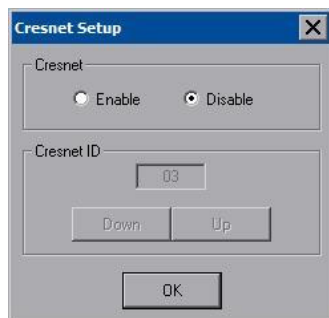

Select **Enable** for normal Cresnet communication mode and **Disable** when the touch screen is connected to a control system via Ethernet. Communication mode is factory set to **Disable**.

The Cresnet network identity number (**Cresnet ID**) is displayed in the **Cresnet Setup** window. Cresnet ID is a two-digit hexadecimal number. The hexadecimal number can range from 03 to FE and must correspond to the Net ID set in the SIMPL Windows program of the Cresnet system. Matching IDs between touch screen and SIMPL Windows program is required if data is to be successfully transferred. The Net ID for the DGE-2 is factory set to 03. No two devices in the same system can have the same Net ID.

Two buttons below the hexadecimal display, **Down** and **Up**, decrease and increase the Cresnet ID by one, respectively.

Select **OK** to accept the changes and return to the setup menu.

Touch Screen

The **Touch Screen** button opens the **Touch Screen Settings** window, which provides access to touch screen calibration when **Calibrate Touch Screen** is touched.

Touch Screen Settings Window

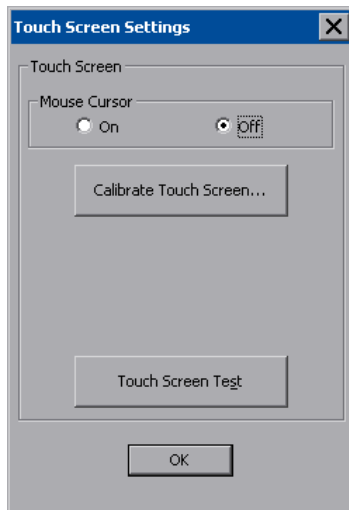

To view the mouse cursor on the touch screen, select **On** in the **Mouse Cursor** section of the window. The mouse cursor is displayed only if a mouse is connected to the touch screen.

When **Calibrate Touch Screen** is touched, the **Touch Device Configuration** window opens.

Touch Device Configuration Window

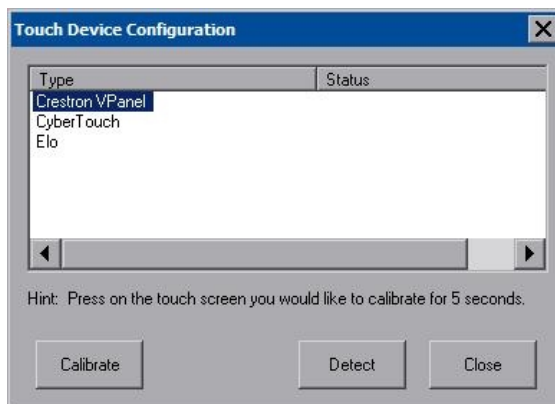

Touch the device **Type**, then touch **Calibrate** to initiate calibration. Touch **Detect** to search for attached touch devices.

When **Calibrate** is touched, the calibration screen is displayed. Touch the screen to begin the calibration process. If the screen is not touched within 60 seconds, the calibration sequence stops and the screen returns to the **Touch Screen Settings** window.

If the screen is touched before the 60 second timeout, the screen instructs the user to touch the center of each target as it appears. There is a series of crosshairs on the screen, starting near the upper left corner. Touch the center of the first crosshair to

initiate calibration. As each new crosshair is touched, the next appears. After the upper left, crosshairs appears in the upper center, upper right, middle left, screen center, middle right, lower left, lower center, and finally, lower right. Touch the center of the crosshair in the lower right of the screen to conclude calibration and return to the **Touch Screen Settings** window. Touch **OK** to accept the changes and return to the setup menu.

NOTE: When touching the screen during calibration, be as accurate as possible. Use the tip of a capped pen or the eraser end of a pencil. To cancel calibration and return to the **Touch Screen Settings** window without saving calibration data, create a calibration error by touching the screen in the same spot for each calibration point.

NOTE: The touch screen's calibration routine can also be accessed through Crestron Toolbox if the touch screen is connected to a control system via Cresnet or TCP/IP by selecting the device from the Network Device Tree and right-clicking the device to select **Functions > Setup Mode...** Select **Enter Calibration Mode** to begin calibration.

When **Touch Screen Test** is touched, the test screen is displayed (refer to the illustration below). This screen allows the user to test the touch screen response at 17 points on the screen. Each button on the screen lights when touched. Touch **Return** to exit the test screen.

Touch Screen Test Window



Display Output

Touching **Display Output** opens a window which shows the display resolution of the touch screen and provides charts for testing the V-Panel glass.

Display Output Window

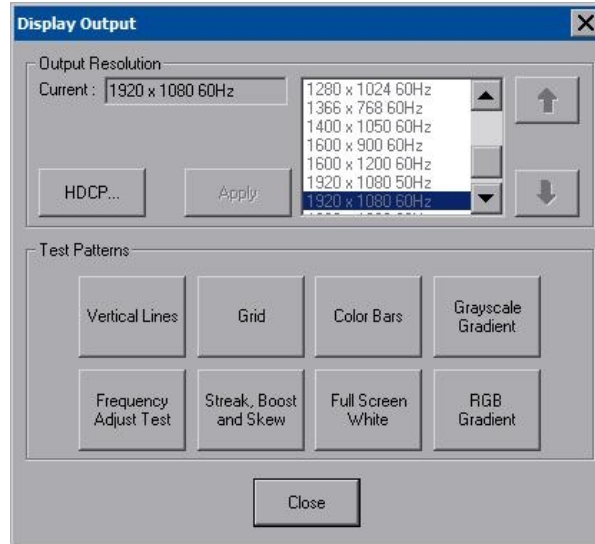

For devices that require HDCP compliance, an informational **HDCP** window opens when **HDCP** is touched. This can be useful when troubleshooting failure to display HDCP content on some display devices.

HDCP Window

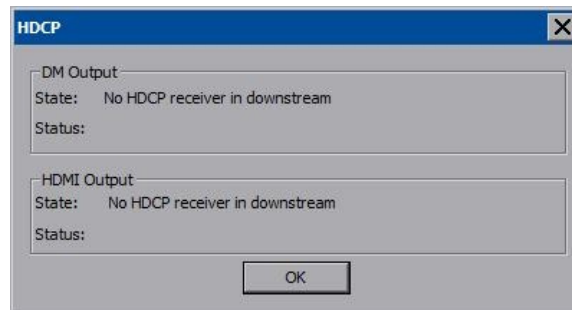

NOTE: HDCP content sent to a display that does not support HDCP results in the display going black. If other displays, which do support HDCP are attached, they continue to display video.

Update Panel

The **Update Panel** button permits the selection of the touch screen program, a .vtz file. It is also used to upgrade firmware.

The **Project** tab of the **Project and Firmware** window is divided into two sections: **Current Loaded Project** and **Load New Project**.

In the **Target Location to Load the Project to** section, the location where the uncompressed project files are stored can be chosen. The default file location is the internal flash.

In the **Load New Project** section, touch **Browse** and select the compiled project (i.e., the .vtz file) to be loaded from a network drive, USB device or flash drive, then touch **Open** to show the source file in the **Project and Firmware** window. Touch **Load** to uncompress the project file, place it in the destination selected in **Target Location to Load the Project to** and display it on the touch screen.

NOTE: If there is a mapped network drive on the touch screen, the first time **Browse** is selected, it may take some time for the **Open** window to appear.

NOTE: When selecting **Browse**, the contents of the **Recent** folder are not available.

NOTE: Projects can also be loaded via Crestron Toolbox.

NOTE: If **External** is checked, the display list cannot be viewed via Crestron Toolbox.

NOTE: When loading a project to an external storage device (e.g. MMC card or flash drive, a subdirectory (not the root) must be used as the working path. Otherwise, the upload may fail.

Project and Firmware Window – Project Tab

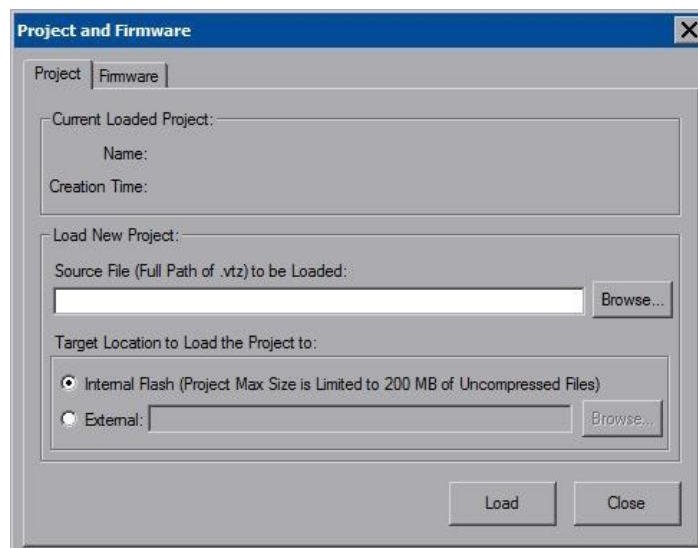

The **Firmware** tab of the **Project and Firmware** window (refer to the following illustration) displays the **Current Loaded Firmware** and also has a **Load New Firmware** section.

Project and Firmware Window – Firmware Tab

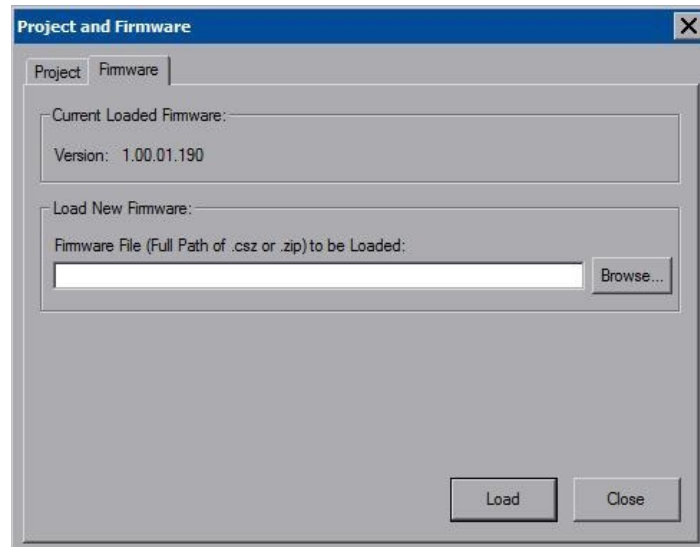

Current Loaded Firmware displays the version of the current firmware.

In the **Load New Firmware** section, touch **Browse** and select the firmware file (i.e., the .csz or .zip file) to be loaded from a network drive, USB device or flash drive. Touch **Load** to load the new firmware.

Video

Each one of the video inputs is selected and adjusted from this window. Touch an input tab and adjust the settings for the selected input.

Video Setup

The setup screen for each video source contains the settings appropriate to that video format, as displayed in the following illustrations. Changes are made in real time.

Video Setup Window (VGA 1 Tab)

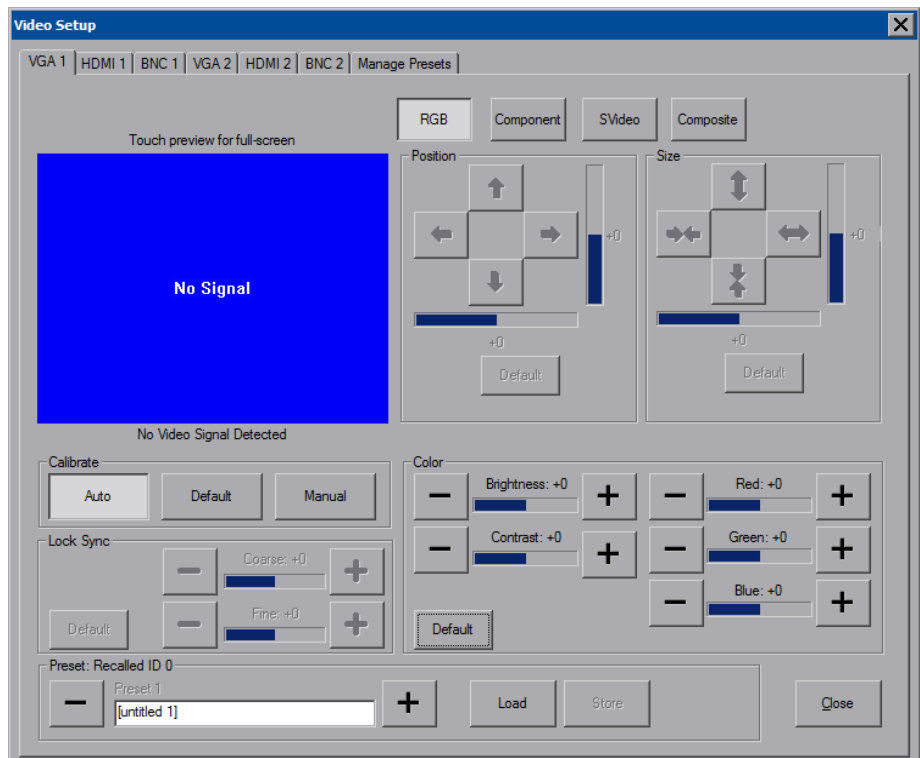

VGA/RGB video is setup using the **Position**, **Size**, **Calibrate**, and **Color** controls (for **Brightness**, **Contrast**, **Red**, **Green**, and **Blue**). Up to 30 presets may be stored for future retrieval.

NOTE: Depending on RGB source, when the video position or size is adjusted beyond a certain value, the video display is black. Reversing the setting restores the video.

NOTE: The DGE-2 uses chroma key color (with RGB values 4,4,4) for rendering video. Any elements in a project (e.g., controls) that use the same color appear transparent on the display.

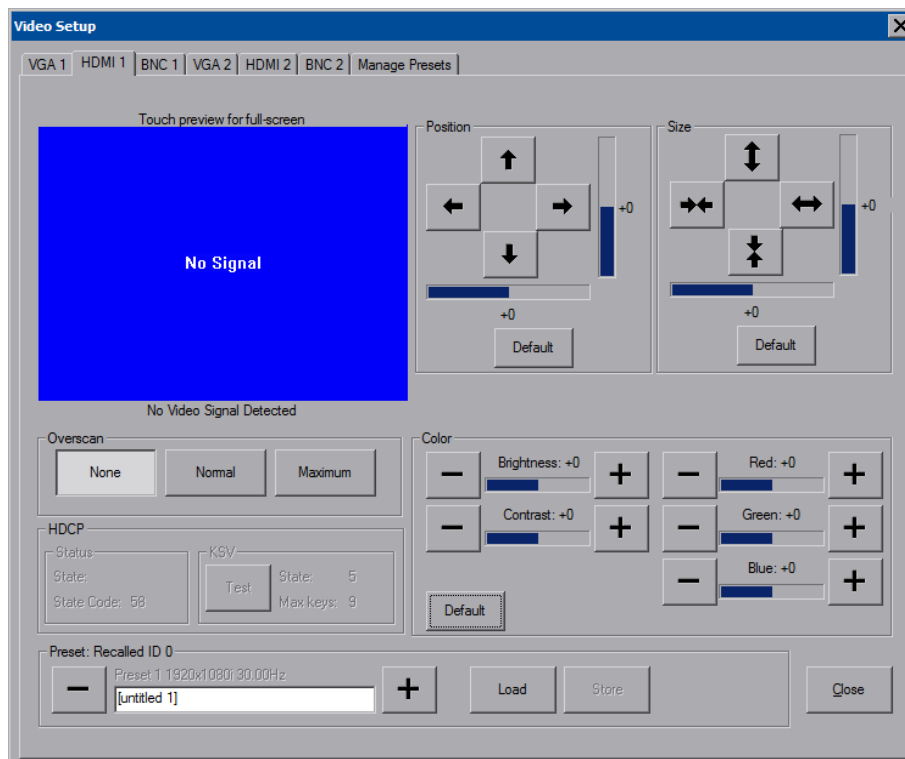
Video Setup Window (HDMI 1 Tab)

HDMI video is setup using the **Position**, **Size**, **Overscan**, and **Color** controls (for **Brightness**, **Contrast**, **Red**, **Green**, and **Blue**). Up to 30 presets may be stored for future retrieval.

NOTE: Depending on HDMI source, when the video position or size is adjusted beyond a certain value, the video display is black. Reversing the setting restores the video.

NOTE: HDMI audio is heard only if the accompanying video source is locked.

Overscan is the active image area in a video picture that is outside the edges of the display device. Overscan adjustment first came about because of noise and other artifacts at the beginning and end of the scan lines. To reliably eliminate the noise and fill the screen with a picture, the outside edge of the active picture area was pushed out past the edge of the display area. The average or targeted overscan loss is about 5 to 10% of the image on each edge. Digital images have nearly eliminated the noise and other artifacts at the edge of the picture, so more of the video image can be safely shown. The **Normal** setting is usually the correct choice for most video inputs.

Video Setup Window (BNC 1 Tab)

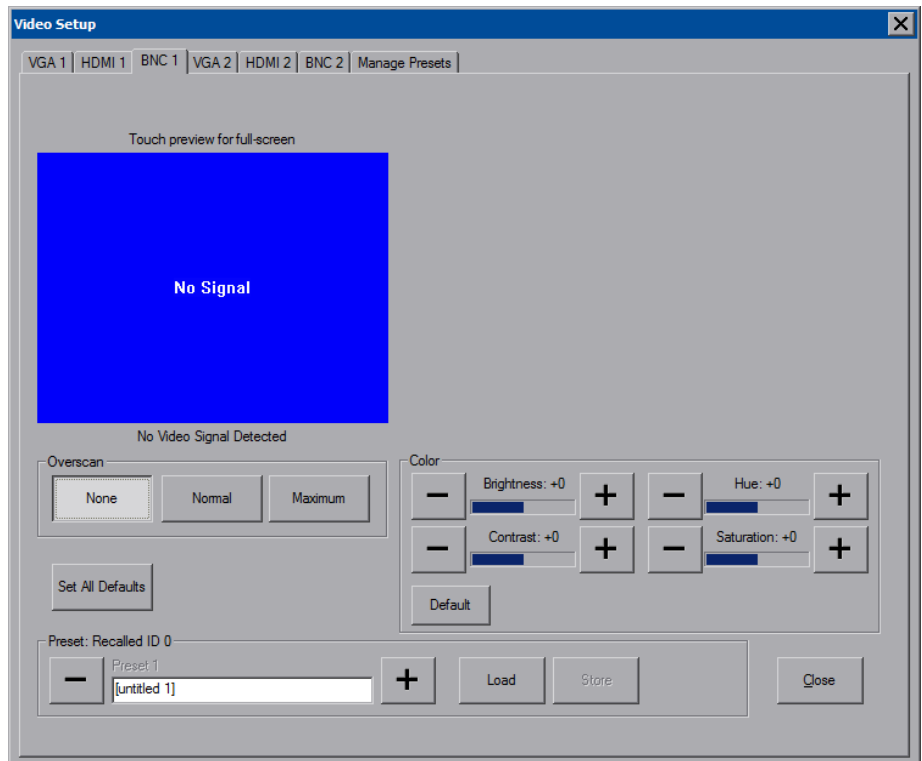

BNC video is setup using the **Overscan** and **Color** controls (for **Brightness**, **Contrast**, **Hue**, and **Saturation**). Up to 30 presets may be stored for future retrieval.

Manage Presets

Use the **Manage Presets** tab to copy presets for one source to other sources.

Video Setup Window (Manage Presets Tab)

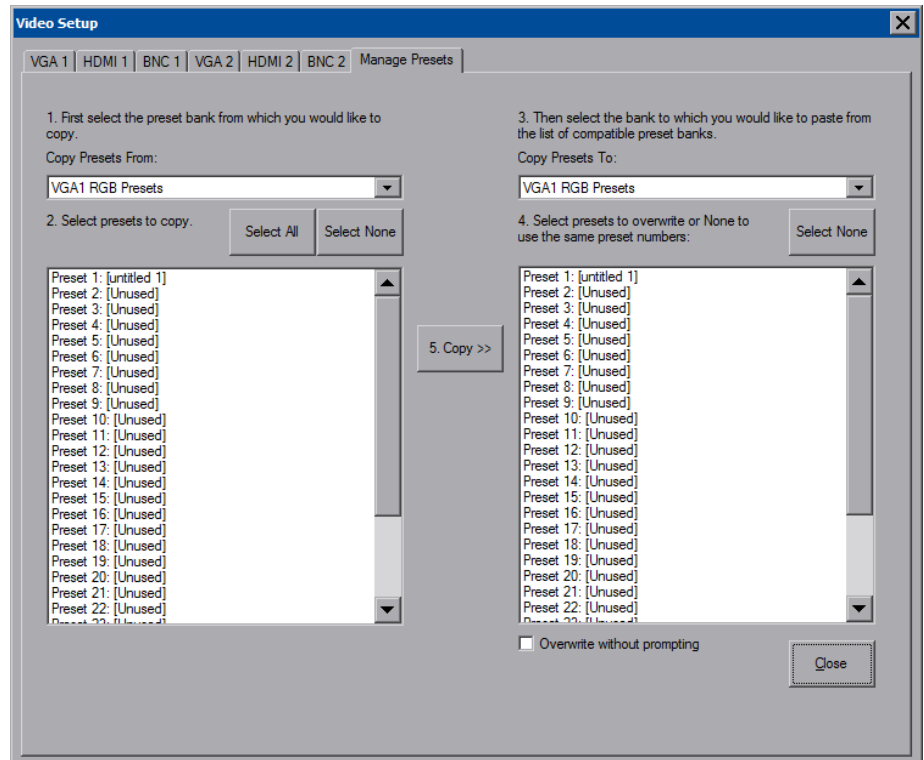

Dual Window Preview

The DGE-2 also offers a dual window preview of its various video inputs. To access the preview window, touch the **Isys i/o** logo in the lower left corner of the main setup menu.

Dual Window Preview Screen

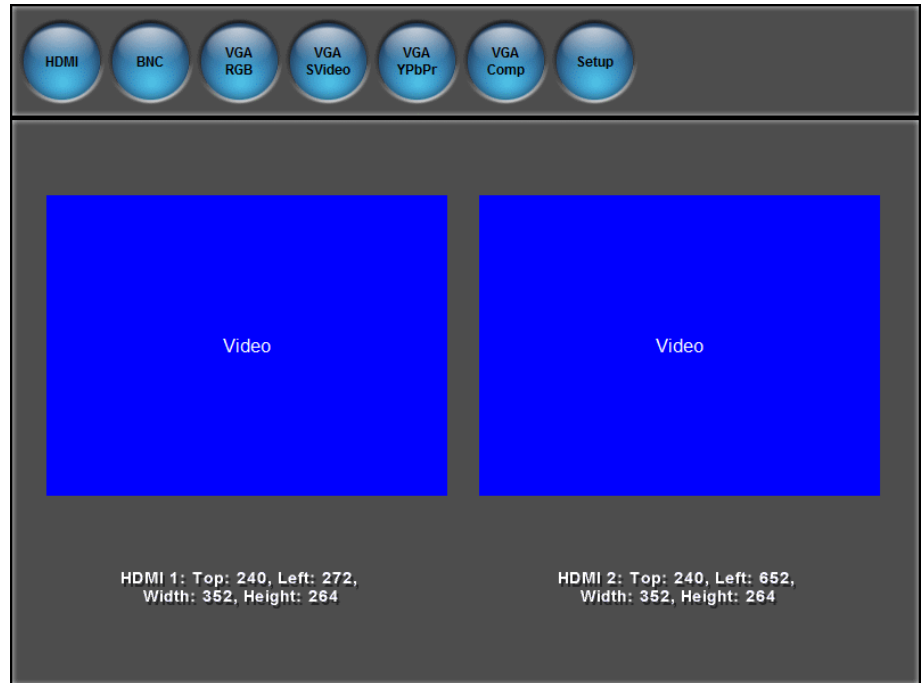

Use the **HDMI**, **BNC**, **VGA RGB**, **VGA SVideo**, **VGA YPbPr** and **VGA Comp** buttons to select the format of the video inputs to preview. Touch **Setup** to return to the main setup menu.

Audio

Touch **Audio** to open the **Audio Setup** window, shown in the illustration below.

Volume controls and **Mute** buttons are available for the **VPanel Glass Speakers** and **VPanel Glass Key Clicks**, as well as a **Mute** button for the **VPanel Glass Microphone**. Volume controls and a **Mute** buttons are also provided for **Local Playback**, the **Analog Input**, **HDMI Input 1**, and **HDMI Input 2** along with a **Mute** button for HDMI output.

When **Local Playback** is selected, touching **Play Test Sound** plays a short internal audio file.

Changes to audio settings are made in real time.

Audio Setup Window

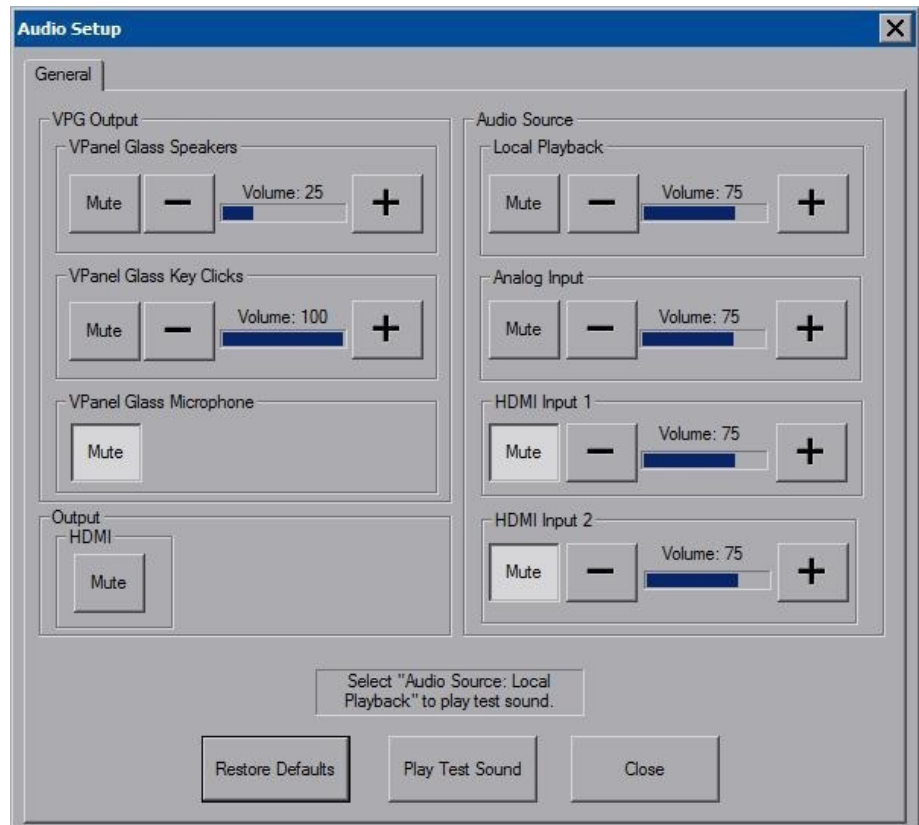

NOTE: V-Panel specific items are not displayed unless there is a V-Panel connected directly to the DGE-2 **DM OUT** ports.

Embed Apps (Embedded Applications)

Touch **Embed Apps** to open the **Embedded Apps** window, which permits setting Internet security to different levels for different types of Internet sites.

Embedded Apps Window

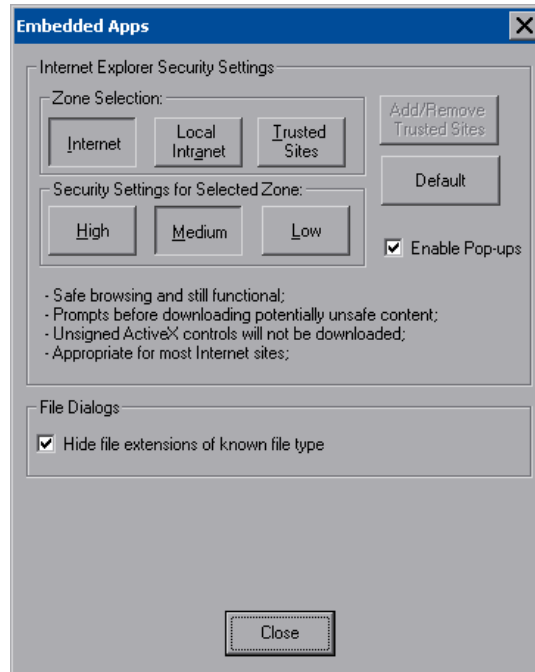

For each of the three zones (**Internet**, **Local Intranet**, and **Trusted Sites**), one of three security levels (**High**, **Medium** or **Low**) can be selected. The security levels are defined as:

- **High** - The safest way to browse but also the least functional. Less secure features are disabled. Appropriate for sites that may have harmful content.
- **Medium** - Safe browsing and still functional. Prompts before downloading potentially unsafe content. Unsigned ActiveX controls are not downloaded. Appropriate for most Internet sites.
- **Low** - Minimal safeguards and warning prompts are provided. Most content is downloaded and run without prompts. All active content can run. Appropriate for sites which are absolutely trusted.

Touch **Default** to restore the default security settings. By default, security is set to **Medium** for **Internet** and **Local Intranet** and **Low** for **Trusted Sites**.

The **Embedded Apps** window also permits enabling the popup windows (child windows) that open when in Internet Explorer (not the popup windows of the embedded applications).

NOTE: Refer to the Crestron website (www.crestron.com), Online Help Answer ID 4190, for information on the latest versions of the software.

Touch **Close** after all changes have been made. The touch screen must be rebooted for changes to take effect. Touch **Save & Reboot**, located in the shutdown section of the setup menu.

A list of trusted sites can be created and edited by touching **Add/Remove Trusted Sites**. Touching this button opens the **Trusted Sites** window. From here, trusted sites can be added and edited. Sites are listed by domain name or IP address. Once all sites have been entered, touch **Close**.

Trusted Sites Window

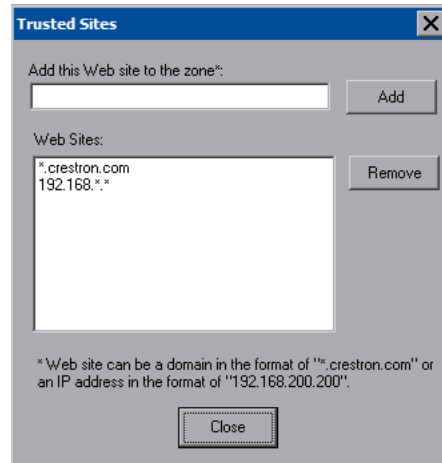

NOTE: Save & Reboot on the setup menu must be selected for Embedded Apps changes to take effect.

NOTE: While browsing the Internet with the DGE-2/V-Panel, clicking on a link may cause a message box titled **Restrictions** to appear that contains the text “This operation has been cancelled due to restrictions in effect on this computer. Please contact the system administrator.” If this message appears, checking **Enable Pop-ups** in the **Embedded Apps** window may correct this error. Other restrictions may also cause this error, so this may not prevent all occurrences.

NOTE: The DGE-2/V-Panel supports automatic connection to the VNC server when the VNC View application is opened. For automatic connection without having to enter the server location and password every time the VNC viewer is opened, launch the application and using a USB mouse, right-click on the VNC viewer window, then select **Save configuration info as**.

NOTE: Refer to the Crestron website, Online Help Answer ID 4627, for information on how to set up the VNC viewer. Refer to Answer ID 3345 for information on how to program the MJPEG viewer. Refer to Answer ID 4640 for information about the default paths for embedded applications and dynamic graphics.

NOTE: When using the embedded applications, only one document window can be open at a time. Opening a second document window causes the first document window to close.

ETHERNET Details

The Ethernet portion of the setup menu allows configuration of the touch screen settings for Ethernet communications.

The Crestron Swirl logo  at the top of the Ethernet portion of the setup menu illuminates to indicate the status of the connection to the control system(s):

- Green Connected
- Yellow Network trouble
- Orange Connected to some but not all of the control systems (listed in IP table)
- Red Not connected to any control system (listed in the IP table)

NOTE: After configuring Ethernet settings (e.g. changing IP address, etc.), wait at least five seconds after seeing the change in the **LAN Ethernet Status** section of the main setup menu before initiating a **Save & Reboot** to save the new settings.

Adapters

Touch the **Adapters** button to access the **Ethernet Setup** window. Changes are made in real time and there is typically no need to reboot. The Ethernet address and mask are displayed on this screen.

Ethernet Setup Window

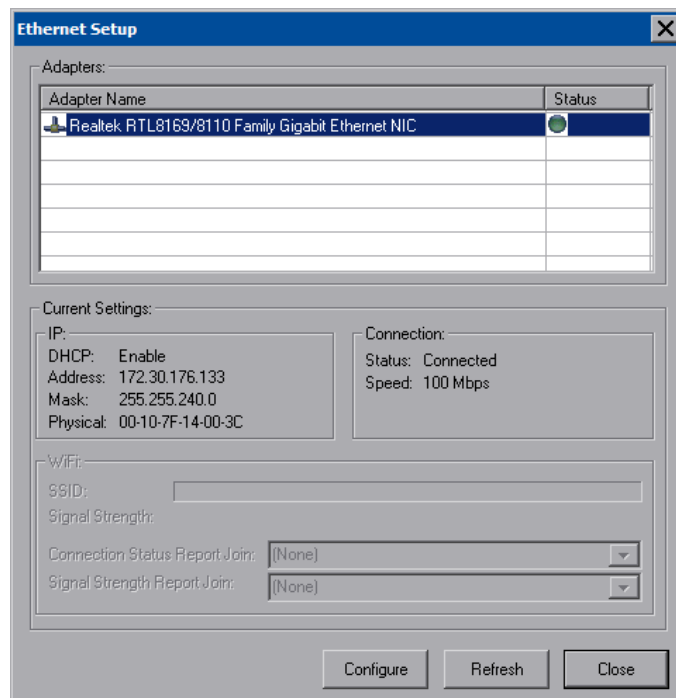

To configure the Ethernet adapter, touch its name once to select it in the **Adapter Name** list. Then, touch **Configure** to open the **Local Area Connection Properties** window. This window displays the connection and related required items.

NOTE: When configuring an adapter, only one item can be modified at a time. For example, to modify an IP address and also change authentication, touch **Configure** and modify the IP address, then touch **OK** (to return to the **Ethernet Setup** window). Touch **Configure** again, change authentication, and then touch **OK**. The order in which modifications are performed does not matter.

Local Area Connection Properties Window

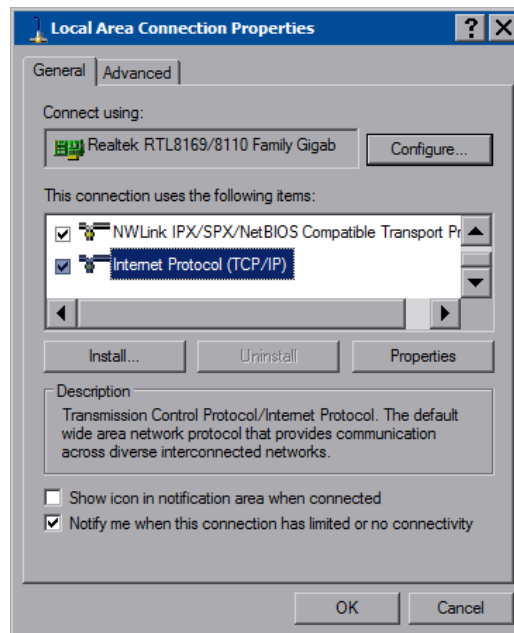

To establish dynamic or static processing, select **Internet Protocol (TCP/IP)** and touch **Properties**.

Internet Protocol (TCP/IP) Properties Window

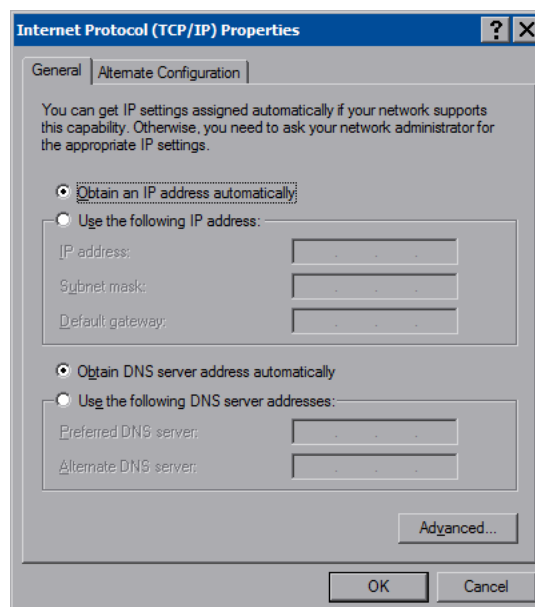

Transmission Control Protocol/Internet Protocol (TCP/IP) is a set of protocols that defines how to transfer data between two computers. TCP monitors and ensures

correct transfer of data. IP receives the data from TCP, breaks it up into packets and ships it off to a network. The IP address is a unique number consisting of four parts (called “octets”) separated by dots, e.g., 165.113.245.2.

Dynamic Host Configuration Protocol (DHCP) is a protocol for assigning dynamic IP addresses to devices on a network. With dynamic addressing, a device can have a different IP address every time it connects to the network. In some systems, the IP address of the device can even change while it is still connected. DHCP also supports a mix of static and dynamic IP addresses.

Dynamic addressing simplifies network administration because the software keeps track of IP addresses rather than requiring an administrator to manage the task. New computers can be added to a network without manually assigning each one a unique IP address.

NOTE: The DGE-2 ships with DHCP enabled.

Static IP addresses on a dedicated AV/control system allow the integrator to have a fixed/controllable network. This helps maintain communication stability between Ethernet devices.

IP Table

Touch **IP Table** on the setup menu to open the **IP Table Setup** window.

Edit, remove or enter a control system’s IP address in the IP table to enable communication between the touch screen and a control system. The touch screen can communicate with multiple control systems.

For more information on IP tables, refer to the latest version of the Crestron 3-Series Control Systems Reference Guide (Doc.7150) at www.crestron.com/manuals.

IP Table Setup Window

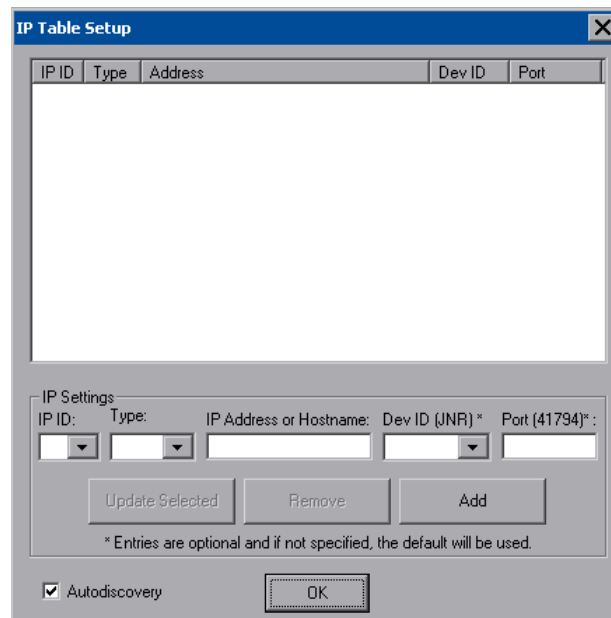

IP ID	Type	Address	Dev ID	Port

IP Settings

IP ID: Type: IP Address or Hostname: Dev ID (JNR)*: Port (41794)*:

* Entries are optional and if not specified, the default will be used.

Autodiscovery

The IP ID is the ID number that is used to identify the touch screen in the control system’s IP table. The IP ID should match the IP ID set in the SIMPL Windows program.

Identity

Touch **Identity** to open the **Network ID** window. The **Network ID** window displays the hostname and workgroup that identify the touch screen on the network. The hostname may be used when transferring a program over Ethernet using Crestron Toolbox. This window permits editing of the hostname and workgroup.

Network ID Window

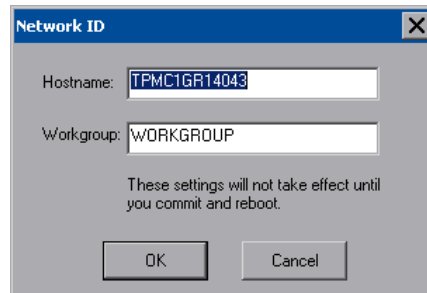

NOTE: The hostname is required for Ethernet communication.

Sharing

Touch **Sharing** to open the **Configure Shared Folders** window. This window is used to set up shared folders. Sharing enables remote computers to view or modify files stored on the touch screen.

Configure Shared Folders Window

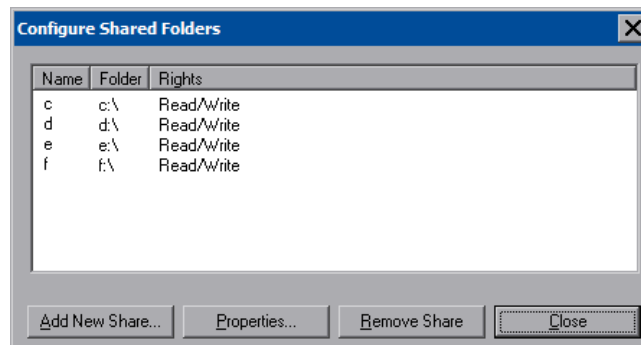

Touch **Add New Share** to browse and add directories with permission to read-only or read/write. Touch **Close** after adding all folders to be shared.

NOTE: For security reasons, there is no persistence of the shared drive(s) after the screen is rebooted.

LAN Ethernet Status Details

The **LAN Ethernet Status** section of the setup menu provides a **Link Status** light to indicate a LAN Ethernet connection and displays the current LAN IP and MAC addresses.

Standby Details

The **Standby** function turns off the backlight when the touch screen is inactive for a specified time. Use the **Up** and **Down** buttons to set the **Standby** from 0 through 120 minutes, where 0 disables the timeout. Touch the screen to reactivate the touch screen from standby mode. When the touch screen is reactivated, the last screen to be displayed reappears.

NOTE: The hard buttons still function when the touch screen is in standby mode but do not cause it to awaken from standby. The screen must be touched to reactivate the touch screen.

Misc. Controls Details

The **Misc. Controls** section of the setup menu contains the **Diagnostics** and **Keyboard** buttons.

Diagnostics

Touch **Diagnostic** to display the firmware version number, see **Installed Packs** and to reset the end user license from the **Diagnostics** window.

Diagnostics Window

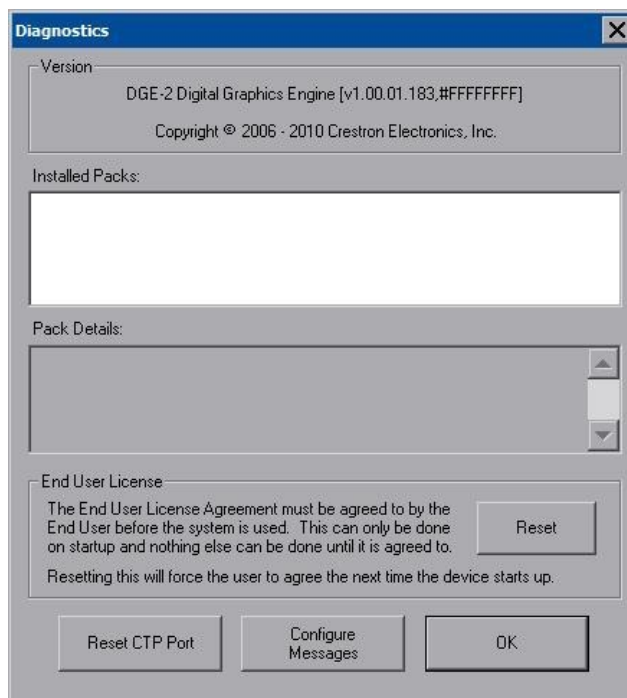

Reset CTP Port resets the default value of the CTP port to 41795, for terminal connection using Crestron Toolbox.

To configure the appearance of popup messages, touch **Configure Messages**. The **Message Popup Configuration** window opens.

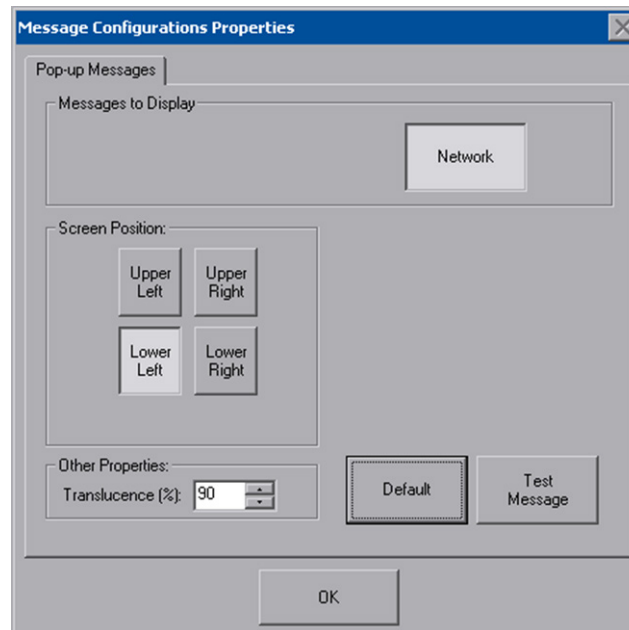
Message Popup Configuration Window

There are three types of network popup messages. Following are definitions of each message type:

- **Connected** - A green popup message appears when the touch screen is connected to the control system.
- **Checking Connection** - A yellow popup message appears when the touch screen is experiencing network issues.
- **Disconnected, Trying to Reconnect** - A red popup message appears when the touch screen loses connection with the control system.

A control for popup message translucence is also provided. Translucence ranges from 25% to 100%, with a default value of 90%.

The **Default** button restores the original **Screen Position** and **Translucence** settings, as well as enabling display of network messages. A **Test Message** button displays the changes to popup message position and translucence. Touch **Close** to close the popup window.

NOTE: The default value for **Screen Position** is **Lower Left**.

Keyboard

Touch the **Keyboard** button to display the on-screen keyboard.

The on-screen keyboard can be used in an identical manner to a physically connected keyboard. It can be used in any of the embedded applications, for example, to enter a web address or to enter data into a spreadsheet, etc.

On-Screen Keyboard



The on-screen keyboard also has a few special keys:

123

Touch the **123** key to change to a numeric keyboard, as shown in the illustration that follows.

On-Screen Keyboard - Numeric



#+=

Touch the **#+=** key to change to a symbol keyboard, as shown in the illustration that follows.

On-Screen Keyboard - Symbols



ABC

From either the numeric or the symbol keyboard, touch the **ABC** key to return to the alpha keyboard.

The initial position of the on-screen keyboard is determined by the VT Pro-e[®] program, Crestron Studio or SIMPL Windows settings. The on-screen keyboard defaults to its largest size.

When the on-screen keyboard is moved or resized and then closed, it re-opens at the same position and size it was when closed. This position and size remains in memory until the touch screen is re-booted or it is re-set by the Crestron Studio or SIMPL Windows program. After reboot, the position of the on-screen keyboard reverts to the default position set in the VT Pro-e, Crestron Studio or SIMPL Windows program. The size reverts to the largest as determined by the firmware installed in the touch screen.

Exit the on-screen keyboard by touching the red close button in the upper right corner of the keyboard window. If the **Keyboard** button on the setup menu is still visible, it can also be touched to exit the keyboard.

VPanel Ethernet Status Details

NOTE: **VPanel Ethernet Status** is not displayed unless there is a V-Panel connected directly to the DGE-2 **DM OUT** ports.

The **VPanel Ethernet Status** section of the setup menu provides a **Link Status** light to indicate an Ethernet connection and displays the current IP and MAC addresses.

Touch **VPG Config** to open the **V-Panel Ethernet Configuration** window.

V-Panel Ethernet Configuration Window



The screenshot shows a configuration window titled "V-Panel Ethernet Configuration". It has a blue header bar with a close button (X) on the right. The main area contains two radio buttons: "DHCP ON" (which is selected) and "DHCP OFF". Below the radio buttons is a group box containing three input fields: "IP Address:", "IP Mask:", and "Default Router:". Below this group box is a "MAC Address:" field with the value "00-10-7F-05-05-F0" entered. At the bottom of the window are two buttons: "Cancel" and "OK".

When **DHCP OFF** is selected, **IP Address**, **IP Mask**, **Default Router**, and **MAC Address** can be entered manually.

Screen Brightness Details

NOTE: **Screen Brightness** is not displayed unless there is a V-Panel connected directly to the DGE-2 **DM OUT** ports.

The **Screen Brightness** can be varied from 0 to 100. To increase the brightness, touch **Up**. To decrease the brightness, touch **Down**.

Hard Button Feedback Details

NOTE: **Hard Button Feedback** is not displayed unless there is a V-Panel connected directly to the DGE-2 **DM OUT** ports.

The **Hard Button Feedback** section of the setup menu provides visual feedback for a hard button press. Pressing the hard button results in the icon on the screen illuminating in bright green.

Touch Path

NOTE: **Touch Path** is not displayed unless there is a V-Panel connected directly to the DGE-2 **DM OUT** ports.

The **Touch Path** indicators show whether is data from the V-Panel is sent to the DGE-2 via the DM connection (“Touch Over DM”) or via the LAN connection (“Touch Over IP”).

Save & Reboot and Shutdown Details

To save any changes and reboot the touch screen, touch **Save & Reboot**, located in the lower right section of the setup menu.

To turn off the touch screen, touch **Shut Down**, located in lower right section of the setup menu. This is the recommended method for shutting down the touch screen. After the touch screen has shut down, the power supply can be safely removed from the touch screen.

Exit Details

Touch **Exit** to leave the setup menu and return to the project. If no project has been loaded, the touch screen displays an error message and return to the setup menu.

Installation

Ventilation

The DGE-2 should be used in a well-ventilated area. The venting holes should not be obstructed under any circumstances.

To prevent overheating, do not operate this product in an area that exceeds the environmental temperature range listed in the table of specifications. Consider using forced air ventilation or increasing the spacing between units to reduce overheating. Contact with thermal insulating materials should be avoided on all sides of the unit.

Rack Mounting

The DGE-2 can be mounted in a rack or stacked with other equipment. Two “ears” are provided with the DGE-2 so that the unit can be rack mounted. These ears must be installed prior to mounting. Complete the following procedure to attach the ears to the unit. The only tool required is a #1 or #2 Phillips screwdriver.

WARNING: To prevent bodily injury when mounting or servicing this unit in a rack, observe the following guidelines:

- When mounting this unit in a partially filled rack, load the rack from the bottom to the top with the heaviest component at the bottom of the rack.
- If the rack is provided with stabilizing devices, install the stabilizers before mounting or servicing the unit in the rack.

NOTE: Observe the following guidelines when installing equipment in a rack:

- **Elevated Operating Ambient Temperature** - If installed in a closed or multi-unit rack assembly, the operating ambient temperature of the rack environment may be greater than room ambient temperature. Therefore, consideration should be given to installing the equipment in an environment compatible with the maximum ambient temperature (T_{ma}) specified by the manufacturer.
- **Reduced Air Flow** - Installation of the equipment in a rack should be such that the amount of airflow required for safe operation of the equipment is not compromised.
- **Mechanical Loading** - Mounting of the equipment in the rack should be such that a hazardous condition is not achieved due to uneven mechanical loading.
- **Circuit Overloading** - Consideration should be given to the connection of the equipment to the supply circuit and the effect that overloading of the circuits might have on overcurrent protection and supply wiring. Appropriate consideration of equipment nameplate ratings should be used when addressing this concern.
- **Reliable Earthing** - Reliable earthing of rack-mounted equipment should be maintained. Particular attention should be given to supply connections other than direct connections to the branch circuit (e.g., use of power strips)

NOTE: If rack mounting is not required, rubber feet are provided for tabletop mounting or stacking. Apply the feet near the corner edges on the underside of the unit.

To install the ears use the following procedure:

CAUTION: To prevent equipment damage, use only the rack ears Crestron provides for this device.

1. There are screws that secure each side of the DGE-2 top cover. Using a #1 or #2 Phillips screwdriver, remove the three screws closest to the front panel from one side of the unit. Refer to the diagram following step 3 for a detailed view.
2. Position a rack ear so that its mounting holes align with the holes vacated by the screws in step 1.
3. Secure the ear to the unit with three of the six #06-32 x 3/8" screws included with the DGE-2, as shown in the following diagram.

Ear Attachment for Rack Mounting

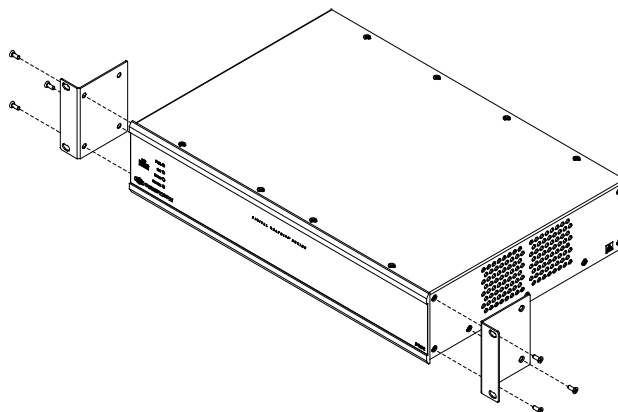

4. Repeat procedure (steps 1 through 3) to attach the remaining ear to the opposite side.

Stacking

Four "feet" are provided with the DGE-2 so that if the unit is not rack mounted, the rubber feet can provide stability when the unit is placed on a flat surface or stacked. These feet should be attached prior to the hookup procedure. Refer to the following illustration for placement of the feet.

Foot Placement for the DGE-2

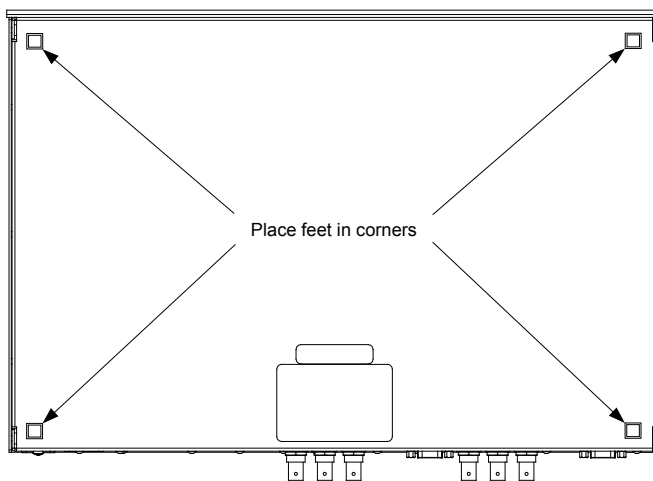

NOTE: No more than two DGE-2 units should be stacked.

Hardware Hookup

Make the necessary connections as called out in the illustration that follows this paragraph. Refer to “Network Wiring” on page 18 before attaching the 4-position terminal block connector. Apply power after all connections have been made.

When making connections to the DGE-2, use Crestron power supplies for Crestron equipment.

Hardware Connections for the DGE-2 (Front View)

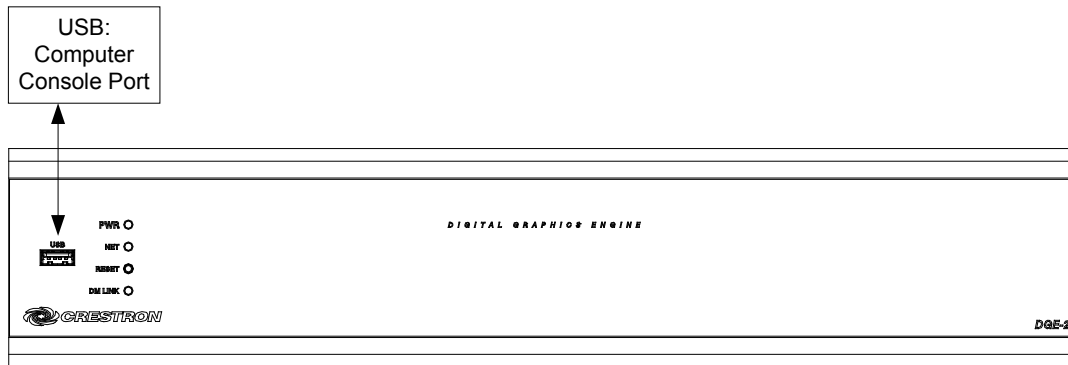

Hardware Connections for the DGE-2 (Rear View)

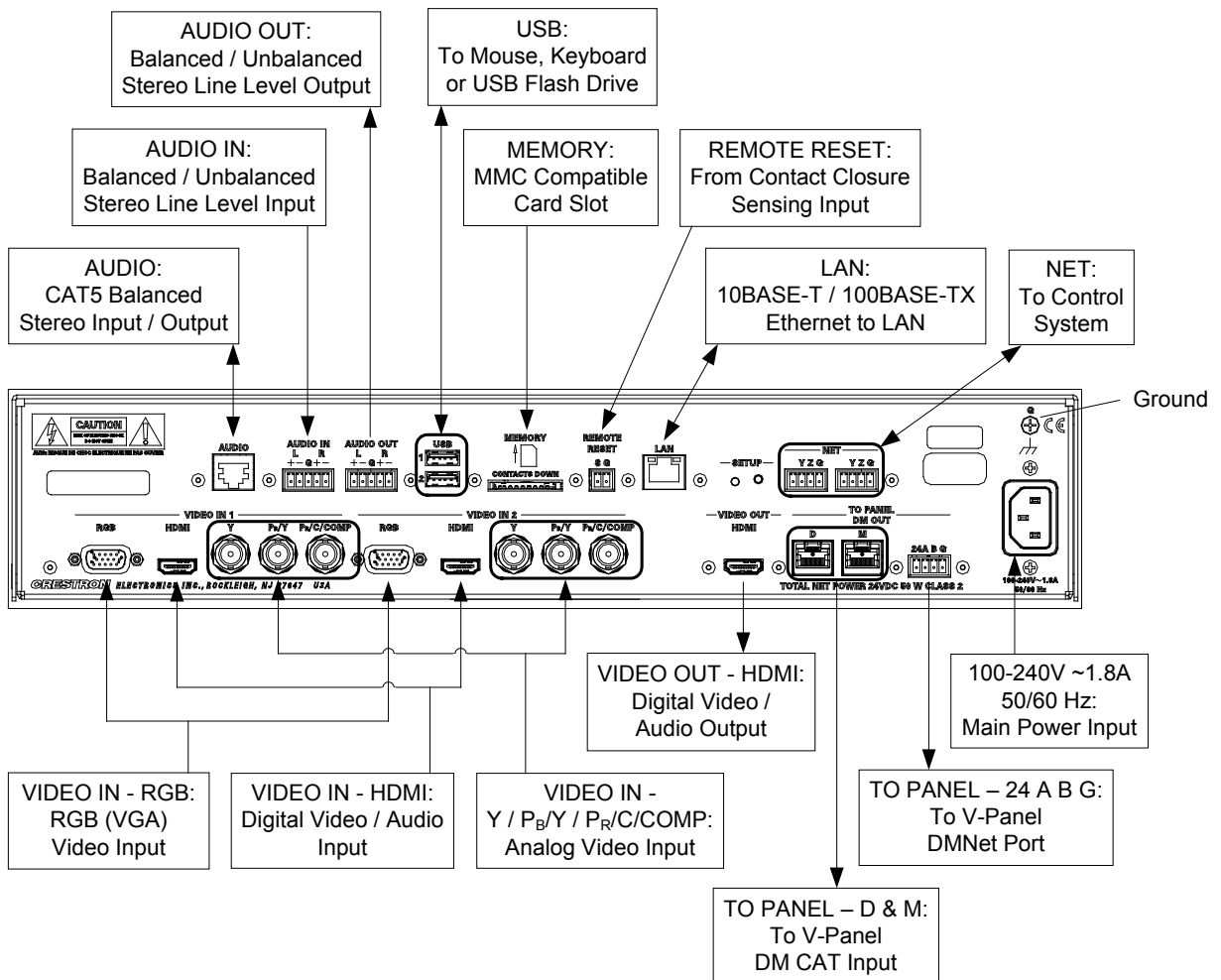

NOTE: Ensure the unit is properly grounded by connecting the chassis ground lug to an earth ground (building steel).

NOTE: To prevent overheating, do not operate this product in an area that exceeds the environmental temperature range listed in the table of specifications.

NOTE: For wiring between the DGE and V-Panel, use DM-CBL DigitalMedia Cable. The maximum cable length is 300 feet (91 meters).

NOTE: When repeaters are used, make sure all D and M cables are connected before connecting DMNet.

NOTE: For audio connections, use either the RJ-45 **AUDIO** connector or the 5-pin **AUDIO IN** and **AUDIO OUT** connectors but not both.

Balanced/unbalanced audio inputs and outputs are provided, utilizing five-pin terminal block connectors. For connection details, refer to the following table and diagrams.

Audio Connections

SIGNAL NAME	BALANCED AUDIO INPUT	BALANCED AUDIO OUTPUT	UNBALANCED AUDIO INPUT	UNBALANCED AUDIO OUTPUT
+	1 +	1 +	1 + In	1 + Out
-	1 -	1 -	1 – signal return, jumper to GND	Open
G	Shield/Ground	Shield/Ground	Ground	Common ground
+	2 +	2 +	2 + In	2 + Out
-	2 -	2 -	2 – signal return jumper to GND	Open

Typical Balanced/Unbalanced Outputs

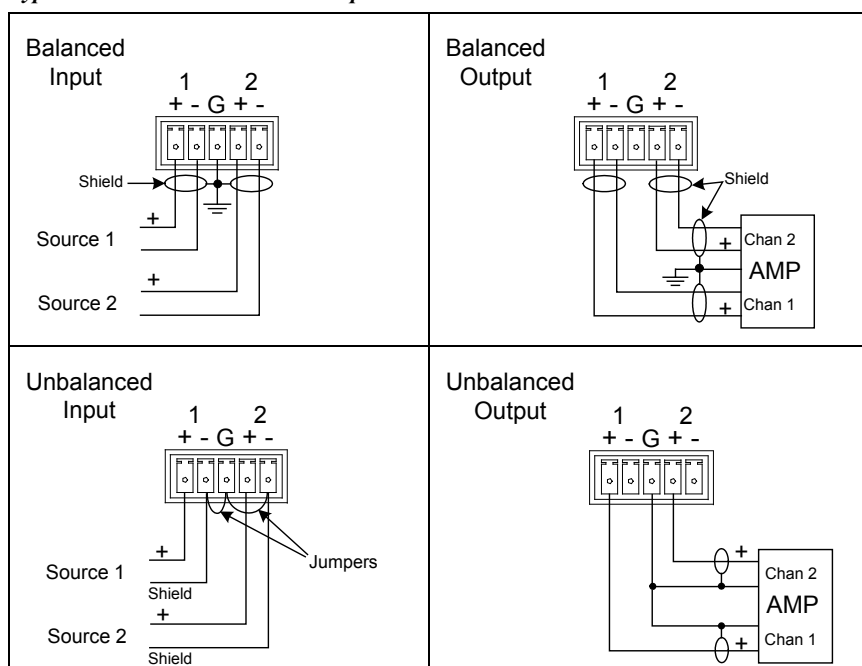

Uploading and Upgrading

Crestron recommends using the latest programming software and that each device contains the latest firmware to take advantage of the most recently released features. However, before attempting to upload or upgrade it is necessary to establish communication. Once communication has been established, files (for example, programs, projects or firmware) can be transferred to the control system (or device). Finally, program checks can be performed (such as changing the device ID or creating an IP table) to ensure proper functioning.

NOTE: Crestron software and any files on the website are for authorized Crestron dealers and Crestron Service Providers (CSPs) only. New users must register to obtain access to certain areas of the site (including the FTP site).

Establishing Communication

Use Crestron Toolbox for communicating with the DGE-2; refer to the Crestron Toolbox help file for details. There is a single method of communication: TCP/IP communication.

Ethernet Communication

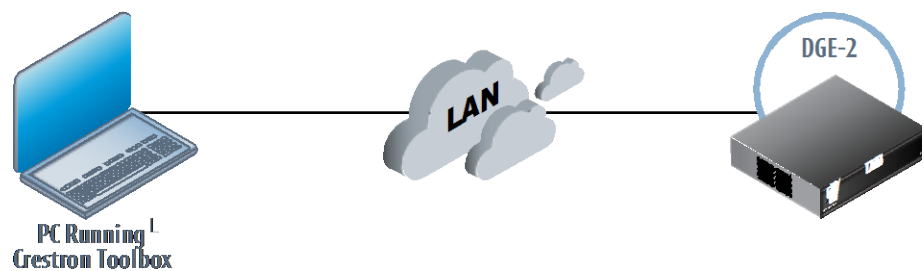

The DGE-2 connects to PC via Ethernet:

1. Use the Device Discovery Tool (click the  icon) in Crestron Toolbox to detect all Ethernet devices on the network and their IP configuration. The tool is available in Toolbox version 1.15.143 or later.
2. Click on the DGE-2 to display information about the device.

Programs, Projects, and Firmware

Program, project or firmware files may be distributed from programmers to installers or from Crestron to dealers. Firmware upgrades are available from the Crestron website as new features are developed after product releases. One has the option to upload programs and projects via the programming software or to upload and upgrade via the Crestron Toolbox. For details on uploading and upgrading, refer to the SIMPL Windows help file, VT Pro-e help file or the Crestron Toolbox help file.

Crestron Studio or SIMPL Windows

If a Crestron Studio (or SIMPL Windows) program is provided, it can be uploaded to the control system using Crestron Studio (or SIMPL Windows) or Crestron Toolbox.

Crestron Studio or VT Pro-e

Upload the Crestron Studio (or VT Pro-e) file to the touch screen using Crestron Studio (or VT Pro-e) or Crestron Toolbox.

Firmware

Check the Crestron website to find the latest firmware. (New users must register to obtain access to certain areas of the site, including the FTP site.)

Upgrade DGE-2 firmware via Crestron Toolbox.

1. Establish communication with the DGE-2 and display the “System Info” window.
2. Select **Functions > Firmware...** to upgrade the DGE-2 firmware.

NOTE: Use an Ethernet connection for loading programs, projects or firmware.

Program Checks

Actions that can be performed on the DGE-2 vary depending on whether it is connected via Cresnet or Ethernet.

Cresnet Connections

For Cresnet connections, using Crestron Toolbox, display the network device tree (**Tools > Network Device Tree View**) to show all network devices connected to the control system. Right-click on the DGE-2 to display actions that can be performed on the DGE-2.

Ethernet Connections

For Ethernet connections, using Crestron Toolbox, display the “System Info window (**Tools > System Info**) and select the **Functions** menu to display actions that can be performed on the DGE-2.

Be sure to use Crestron Toolbox to create the DGE-2 IP table.

1. Select **Functions > IP Table Setup**.
2. Add, modify or delete entries in the IP table. The DGE-2 can have only one IP table entry.
3. A defined IP table can be saved to a file or sent to the device.

Edit the control system’s IP table to include an entry for the DGE-2. The entry should list the DGE-2’s IP ID (specified on the DGE-2’s IP table) and the internal gateway IP address 127.0.0.1.

Restore

The `restore` console command restores the DGE-2 to its original factory default settings and also restores the original version of the firmware.

NOTE: Use of the `restore` console command requires all service packs to be re-installed as well.

Operation – Security Infrastructure

Since the DGE-2 does not use a traditional hard drive but rather an image that is restored every time the touch screen is rebooted, any virus infection is cleared immediately after a reboot. However, using the currently available tools and techniques, Crestron has provided an infrastructure that protects against possible virus infections.

- **Executables/Scripts brought in on external media**
The implementation of the DGE-2 series has restrictions on starting any application or script. The only applications that can be started are those allowed by Crestron and these can only be started from the Crestron project.
- **Downloaded Program/Script**
The browser is customized in such a way that files cannot be downloaded. The only files the browser can open are the files it has plug-ins for, such as PDF, etc. The user cannot change the options, as this window has been disabled.
- **Browser Hijack and Browser vulnerability**
Crestron has patched all currently known hijacks and vulnerabilities. Future updates can be downloaded from the Crestron website.
- **Email Viruses**
There is no e-mail client installed on the DGE-2, so email-based viruses cannot be executed.
- **Viruses that attack web/FTP servers**
The DGE-2 does not run a web or FTP server and is therefore not listening to port 21 or 80. The only ports the system listens to are the ports registered to Crestron.
- **Virus from other machines on the network**
Since drives on the DGE-2 can be shared on the network, it is possible that a virus can write itself to files/folders on these shares. Our recommendation therefore is to share as “Read-Only”, so that viruses cannot attach themselves to files on the DGE-2.
- **ActiveX and Java**
The DGE-2 has ActiveX disabled and has no Java Virtual Machine installed. These applets cannot run on the DGE-2.

NOTE: While browsing the Internet with the DGE-2, clicking on a link may cause a message box titled “Restrictions” to appear that contains the text “This operation has been cancelled due to restrictions in effect on this computer. Please contact the system administrator.” If this message appears, checking *Enable Pop-ups* in the “Embedded Apps” window (refer to “Embed Apps (Embedded Applications)” on page 35) may correct this error. Other restrictions may also cause this error, so this may not prevent all occurrences.

Problem Solving

Troubleshooting

The following table provides corrective action for possible trouble situations. If further assistance is required, please contact a Crestron customer service representative.

DGE-2 Troubleshooting

TROUBLE	POSSIBLE CAUSE(S)	CORRECTIVE ACTION
Touch screen does not function.	Touch screen is not communicating with the network.	Use Crestron Toolbox (via SIMPL Windows or VT Pro-e) to poll the network. Verify network connection to the touch screen.
	Touch screen is incorrectly calibrated.	Enter the setup menu or use Crestron Toolbox to initiate the calibration sequence and recalibrate. (Refer to "Touch Screen" on page 24.)
Touch screen is not responding.	The network wiring is incorrect.	Touch the screen to remove any message and verify correct wiring to all connectors.
	Touch screen Cresnet ID is not set to match the Net ID in the SIMPL program.	Use Crestron Toolbox to poll the network. Verify that the Cresnet ID for the touch screen is properly set to match the Net ID in the SIMPL program.
	Touch screen Cresnet ID is not unique; two or more units share the same ID.	Use Crestron Toolbox to poll the network and verify that each ID is used only once.
Touch screen display is dark.	Standby timeout has elapsed.	Touch the screen to reactivate.
	Screen brightness is improperly set.	Adjust screen brightness from the Video Setup" menu. (Refer to "Video Setup" on page 29.)
Unexpected response from the touch screen.	Touch screen is incorrectly calibrated.	Enter the setup menu or use Crestron Toolbox to initiate the calibration sequence and recalibrate. (Refer to "Touch Screen" on page 24.)

(Continued on following page)

DGE-2 Troubleshooting (Continued)

TROUBLE	POSSIBLE CAUSE(S)	CORRECTIVE ACTION
Video window on touch screen has no display.	There is an improper video connection.	Verify proper connections on the touch screen.
	The video cable used is incorrect.	Verify that the correct video cable is being used.
	The video format selection is incorrect.	Select the proper video input configuration in the touch screen configuration setup menu. (Refer to "Video" on page 29.)
	The VT Pro-e project file loaded is incorrect.	Make sure that video window object resides in project, re-compile and reload.
Communications via the LAN port is not functioning.	The Ethernet connection (IEC) is not proper.	Verify proper connection at touch screen LAN port.
	Incorrect touch screen selected in SIMPL Windows.	Select "Touchpanel (Ethernet)" instead of "Touchpanel (Cresnet)".
	Another device set to the same IP address.	Obtain new touch screen static IP address.
	Possible bad port on the hub.	Use crossover cable to connect directly to the Ethernet port on a PC and ping the IP address of the touch screen to confirm communication. If it is good, confirm hub port by testing with another Ethernet device.

NOTE: For more advanced diagnostics, use the DM tool in Crestron Toolbox.

Check Network Wiring

Use the Right Wire

To ensure optimum performance over the full range of the installation topology, use Crestron Certified Wire only. Failure to do so may incur additional charges if support is required to identify performance deficiencies because of using improper wire.

Calculate Power

CAUTION: Use only Crestron power supplies for Crestron equipment. Failure to do so could cause equipment damage or void the Crestron warranty.

CAUTION: Provide sufficient power to the system. Insufficient power can lead to unpredictable results or damage to the equipment. The **EIG** connector on the DM switcher is used to bring in external power. Additional power is rarely required as switchers provide enough power for most typical configurations. Please use the DMNet Power Calculator to help calculate how much power is needed for the system (www.crestron.com/calculators).

CAUTION: If a DM Switcher or other DM device supplying power is connected to the DGE-2, the wire to the **24** pin between the DM device and the DGE-2 must be disconnected. The wires to the **A**, **B** and **G** pins must remain connected.

Refer to the following table for maximum cable lengths using various cables.

Maximum DM CAT Cable Length

Cable Type:	DM-CBL DigitalMedia Cable	
Resolution:	Maximum length without, between, before or after repeater	Maximum total length using one repeater
720p	150 ft (45 m)	300 ft (91 m)
800 x 600 @ 60 Hz (V12)	150 ft (45 m)	300 ft (91 m)
1024 x 768 @ 60 Hz	150 ft (45 m)	300 ft (91 m)
1080p (TSD-2020)	150 ft (45 m)	300 ft (91 m)
1280 x 768 @ 60 Hz (V15)	150 ft (45 m)	300 ft (91 m)
1280 x 1024 @ 60 Hz	150 ft (45 m)	300 ft (91 m)
1920 x 1200 @ 60 Hz (V24R-C)	150 ft (45 m)	300 ft (91 m)
1600 x 1200 @ 60 Hz	125 ft (38 m)	250 ft (76 m)

NOTE: A DM 8G+ transmitter is required when used with a V24R-C touch screen display, supporting a maximum cable length of 330 feet (100 meters). No repeaters are necessary when used with a V24R-C.

NOTE: 1080p60 is the most common resolution used in residential installations.

NOTE: All Crestron certified DMNet wiring must consist of two twisted pairs. One twisted pair is the **24** and **G** pair and the other twisted pair is the **Y** and **Z** pair.

Reference Documents

All documents mentioned in this guide are available at www.crestron.com/manuals.

List of Related Reference Documents

DOCUMENT TITLE
3-Series Control Systems Reference Guide
Crestron e-Control Reference Guide
DigitalMedia Design Guide

Further Inquiries

To locate specific information or resolve questions after reviewing this guide, contact Crestron's True Blue Support at 1-888-CRESTRON [1-888-273-7876] or, for assistance within a particular geographic region, refer to the listing of Crestron worldwide offices at www.crestron.com/offices.

To post a question about Crestron products, log onto Crestron's Online Help at www.crestron.com/onlinehelp. First-time users must establish a user account to fully benefit from all available features.

Future Updates

As Crestron improves functions, adds new features and extends the capabilities of the DGE-2, additional information may be made available as manual updates. These updates are solely electronic and serve as intermediary supplements prior to the release of a complete technical documentation revision.

Check the Crestron website periodically for manual update availability and its relevance. Updates are identified as an “Addendum” in the Download column.

Return and Warranty Policies

Merchandise Returns / Repair Service

1. No merchandise may be returned for credit, exchange or service without prior authorization from Crestron. To obtain warranty service for Crestron products, contact an authorized Crestron dealer. Only authorized Crestron dealers may contact the factory and request an RMA (Return Merchandise Authorization) number. Enclose a note specifying the nature of the problem, name and phone number of contact person, RMA number and return address.
2. Products may be returned for credit, exchange or service with a Crestron Return Merchandise Authorization (RMA) number. Authorized returns must be shipped freight prepaid to Crestron, 6 Volvo Drive, Rockleigh, N.J. or its authorized subsidiaries, with RMA number clearly marked on the outside of all cartons. Shipments arriving freight collect or without an RMA number shall be subject to refusal. Crestron reserves the right in its sole and absolute discretion to charge a 15% restocking fee plus shipping costs on any products returned with an RMA.
3. Return freight charges following repair of items under warranty shall be paid by Crestron, shipping by standard ground carrier. In the event repairs are found to be non-warranty, return freight costs shall be paid by the purchaser.

Crestron Limited Warranty

Crestron Electronics, Inc. warrants its products to be free from manufacturing defects in materials and workmanship under normal use for a period of three (3) years from the date of purchase from Crestron, with the following exceptions: disk drives and any other moving or rotating mechanical parts, pan/tilt heads and power supplies are covered for a period of one (1) year; touch screen display and overlay components are covered for 90 days; batteries and incandescent lamps are not covered.

This warranty extends to products purchased directly from Crestron or an authorized Crestron dealer. Purchasers should inquire of the dealer regarding the nature and extent of the dealer's warranty, if any.

Crestron shall not be liable to honor the terms of this warranty if the product has been used in any application other than that for which it was intended or if it has been subjected to misuse, accidental damage, modification or improper installation procedures. Furthermore, this warranty does not cover any product that has had the serial number altered, defaced or removed.

This warranty shall be the sole and exclusive remedy to the original purchaser. In no event shall Crestron be liable for incidental or consequential damages of any kind (property or economic damages inclusive) arising from the sale or use of this equipment. Crestron is not liable for any claim made by a third party or made by the purchaser for a third party.

Crestron shall, at its option, repair or replace any product found defective, without charge for parts or labor. Repaired or replaced equipment and parts supplied under this warranty shall be covered only by the unexpired portion of the warranty.

Except as expressly set forth in this warranty, Crestron makes no other warranties, expressed or implied, nor authorizes any other party to offer any warranty, including any implied warranties of merchantability or fitness for a particular purpose. Any implied warranties that may be imposed by law are limited to the terms of this limited warranty. This warranty statement supersedes all previous warranties.

Crestron software, including without limitation, product development software and product operating system software is licensed to Crestron dealers and Crestron Service Providers (CSPs) under a limited non-exclusive, non-transferable license pursuant to a separate end-user license agreement. The terms of this end user license agreement can be found at www.crestron.com/legal/software_license_agreement.

Microsoft® Windows XP Embedded End User License Agreement

- You have acquired a device (“DEVICE”) that includes software licensed by Crestron Electronics from Microsoft Licensing Inc. or its affiliates (“MS”). Those installed software products of MS origin, as well as associated media, printed materials, and “online” or electronic documentation (“SOFTWARE”), are protected by international intellectual property laws and treaties. The SOFTWARE is licensed, not sold. All rights reserved.
- IF YOU DO NOT AGREE TO THIS END USER LICENSE AGREEMENT (“EULA”), DO NOT USE THE DEVICE OR COPY THE SOFTWARE. INSTEAD, PROMPTLY CONTACT CRESTRON ELECTRONICS FOR INSTRUCTIONS ON RETURN OF THE UNUSED DEVICE(S) FOR A REFUND. **ANY USE OF THE SOFTWARE, INCLUDING BUT NOT LIMITED TO USE ON THE DEVICE, WILL CONSTITUTE YOUR AGREEMENT TO THIS EULA (OR RATIFICATION OF ANY PREVIOUS CONSENT).**
- **GRANT OF SOFTWARE LICENSE.** This EULA grants you the following license:
 - You may use the SOFTWARE only on the DEVICE.
 - **NOT FAULT TOLERANT.** THE SOFTWARE IS NOT FAULT TOLERANT. CRESTRON ELECTRONICS HAS INDEPENDENTLY DETERMINED HOW TO USE THE SOFTWARE IN THE DEVICE, AND MS HAS RELIED UPON CRESTRON ELECTRONICS TO CONDUCT SUFFICIENT TESTING TO DETERMINE THAT THE SOFTWARE IS SUITABLE FOR SUCH USE.
 - NO WARRANTIES FOR THE SOFTWARE. **THE SOFTWARE IS PROVIDED “AS IS” AND WITH ALL FAULTS. THE ENTIRE RISK AS TO SATISFACTORY QUALITY, PERFORMANCE, ACCURACY, AND EFFORT (INCLUDING LACK OF NEGLIGENCE) IS WITH YOU. ALSO, THERE IS NO WARRANTY AGAINST INTERFERENCE WITH YOUR ENJOYMENT OF THE SOFTWARE OR AGAINST INFRINGEMENT.** IF YOU HAVE RECEIVED ANY WARRANTIES REGARDING THE DEVICE OR THE SOFTWARE, THOSE WARRANTIES DO NOT ORIGINATE FROM, AND ARE NOT BINDING ON, MS.
 - No Liability for Certain Damages. **EXCEPT AS PROHIBITED BY LAW, MS SHALL HAVE NO LIABILITY FOR ANY INDIRECT, SPECIAL, CONSEQUENTIAL OR INCIDENTAL DAMAGES ARISING FROM OR IN CONNECTION WITH THE USE OR PERFORMANCE OF THE SOFTWARE. THIS LIMITATION SHALL APPLY EVEN IF ANY REMEDY FAILS OF ITS ESSENTIAL PURPOSE. IN NO EVENT SHALL MS BE LIABLE FOR ANY AMOUNT IN EXCESS OF U.S. TWO HUNDRED FIFTY DOLLARS (U.S. \$250.00).**
 - **Limitations on Reverse Engineering, Decompilation, and Disassembly.** You may not reverse engineer, decompile, or disassemble the SOFTWARE, except and only to the extent that such activity is expressly permitted by applicable law notwithstanding this limitation.
 - **SOFTWARE TRANSFER ALLOWED BUT WITH RESTRICTIONS.** You may permanently transfer rights under this EULA only as part of a permanent sale or transfer of the Device, and only if the recipient agrees to this EULA. If the SOFTWARE is an upgrade, any transfer must also include all prior versions of the SOFTWARE.
 - **EXPORT RESTRICTIONS.** You acknowledge that SOFTWARE is subject to U.S. export jurisdiction. You agree to comply with all applicable international and national laws that apply to the SOFTWARE, including the U.S. Export Administration Regulations, as well as end-user, end-use and destination restrictions issued by U.S. and other governments. For additional information, see www.microsoft.com/exporting.
- **Limited Use of Particular SOFTWARE Services.** Provided that the DEVICE continues to comply with the terms of the “Restricted Functionality” paragraph below, without limiting the number of computers or other electronic devices that might connect to the DEVICE to access or utilize other software or SOFTWARE services on the DEVICE, you may permit a maximum of ten (10) computers or other electronic devices to connect to the DEVICE to utilize the services of the SOFTWARE for (a) file and print services, (b) Internet information services, and/or (c) remote access (including connection sharing). The ten (10) connections maximum includes any indirect connections made through “multiplexing” or other software or hardware which pools or aggregates connections.
- If you use the DEVICE to access or utilize the services or functionality of Microsoft Windows Server products (such as Microsoft Windows NT Server 4.0 (all editions) or Microsoft Windows 2000 Server (all editions)), or use the DEVICE to permit workstation or computing devices to access or utilize the services or functionality of Microsoft Windows Server products, you may be required to obtain a Client Access License for the DEVICE and/or each such workstation or computing device. Please refer to the End-User License Agreement for your Microsoft Windows Server product for additional information.
- **Restricted Deployment.** The SOFTWARE is not designed or intended for use or resale in hazardous environments requiring fail-safe performance, such as in the operation of nuclear facilities, aircraft navigation or communication systems, air traffic control, or other devices or systems in which a malfunction of the SOFTWARE would result in foreseeable risk of injury or death to the operator of the device or system, or to others.
- **Restricted Functionality.** You are licensed to use the SOFTWARE to provide only the limited functionality (specific tasks or processes) for which the DEVICE has been designed and marketed by Crestron. This license specifically prohibits any other use of the SOFTWARE, or inclusion of additional software programs or functions, on the DEVICE. Subject to the terms of the “Limited Use of Particular Services” paragraph above, you may use the SOFTWARE on the DEVICE to interact with other computers or electronic devices.

- **Maximum Number of Processors.** The SOFTWARE may not be used by more than two (2) processors at any one time on the DEVICE.
- **Remote Boot Feature.** Your DEVICE may be enabled with a Remote Boot feature which includes Remote Boot Installation Services tool. You may use the Remote Boot Installation Services tool only to deploy the SOFTWARE to one or more DEVICES on which you are licensed to run the SOFTWARE (i.e., DEVICES to which the appropriate Certificate of Authenticity is affixed). Please refer to the DEVICE documentation, if provided with your DEVICE, or contact Crestron for additional information.
- **Security Updates.** Content providers are using the digital rights management technology (“Microsoft DRM”) contained in this SOFTWARE to protect the integrity of their content (“Secure Content”) so that their intellectual property, including copyright, in such content is not misappropriated. Owners of such Secure Content (“Secure Content Owners”) may, from time to time, request MS, Microsoft Corporation, or their subsidiaries to provide security related updates to the Microsoft DRM components of the SOFTWARE (“Security Updates”) that may affect your ability to copy, display, and/or play Secure Content through Microsoft software or third-party applications that utilize Microsoft DRM. You therefore agree that, if you elect to download a license from the Internet, which enables our use of Secure Content, MS, Microsoft Corporation, or their subsidiaries may, in conjunction with such license, also download onto your DEVICE such Security Updates that a Secure Content Owner has requested that MS, Microsoft Corporation, or their subsidiaries distribute. MS, Microsoft Corporation, or their subsidiaries will not retrieve any personally identifiable information, or any other information, from your DEVICE by downloading such Security Updates.
- **Consent to Use of Data.** You agree that MS, Microsoft Corporation, and their affiliates may collect and use technical information gathered in any manner as part of product support services related to the SOFTWARE. MS, Microsoft Corporation, and their affiliates may use this information solely to improve their products or to provide customized services or technologies to you. MS, Microsoft Corporation, and their affiliates may disclose this information to others, but not in a form that personally identifies you.
- **Internet Gaming/Update Features.** If the SOFTWARE provides, and you choose to utilize, the Internet gaming or update features within the SOFTWARE, it is necessary to use certain computer system, hardware, and software information to implement the features. By using these features, you explicitly authorize MS, Microsoft Corporation, and/or their designated agent to use this information solely to improve their products or to provide customized services or technologies to you. MS or Microsoft Corporation may disclose this information to others, but not in a form that personally identifies you.
- **Internet –Based Services Components.** The SOFTWARE may contain components that enable and facilitate the use of certain Internet-based services. You acknowledge and agree that MS, Microsoft Corporation, or their affiliates may automatically check the version of the SOFTWARE and/or its components that you are utilizing and may provide upgrades or supplements to the SOFTWARE that may be automatically downloaded to your Device.
- **Links to Third-Party Sites.** The SOFTWARE may provide you with the ability to link to third-party sites through the use of the SOFTWARE. The third-party sites are not under the control of MS, Microsoft Corporation, or their affiliates. Neither MS nor Microsoft Corporation nor their affiliates are responsible for (i) the contents of any third-party sites, any links contained in third-party sites, or any changes or updates to third-party sites, or (ii) webcasting or any other form of transmission received from any third-party sites. If the SOFTWARE provides links to third-party sites, those links are provided to you only as a convenience, and the inclusion of any link does not imply an endorsement of the third-party site by MS, Microsoft Corporation, or their affiliates.
- **Additional Software/Services.** The SOFTWARE may permit Crestron, MS, Microsoft Corporation, or their affiliates to provide or make available to you SOFTWARE updates, supplements, add-on components, or Internet-based services components of the SOFTWARE after the date you obtain your initial copy of the SOFTWARE (“Supplemental Components”).
 - If Crestron provides or makes available to you Supplemental Components and no other EULA terms are provided along with the Supplemental Components, then the terms of this EULA shall apply.
 - If MS, Microsoft Corporation, or their affiliates make available Supplemental Components, and no other EULA terms are provided, then the terms of this EULA shall apply, except that the MS, Microsoft Corporation, or affiliate entity providing the Supplemental Component(s) shall be the licensor of the Supplemental Component(s).

Crestron, MS, Microsoft Corporation, and their affiliates reserve the right to discontinue any Internet-based services provided to you or made available to you through the use of the SOFTWARE.

This EULA does not grant you any rights to use the Windows Media Format Software Development Kit (“WMFSDK”) components contained in the SOFTWARE to develop a software application that uses Windows Media technology. If you wish to use the WMFSDK to develop such an application, visit <http://msdn.microsoft.com/workshop/imedia/windowsmedia/sdk/wmsdk.asp>, accept a separate license for the WMFSDK, download the appropriate WMFSDK, and install it on your system.



Crestron Electronics, Inc.
15 Volvo Drive Rockleigh, NJ 07647
Tel: 888.CRESTRON
Fax: 201.767.7576
www.crestron.com



Operations Guide – DOC. 6809J
(2024099)

10.14

Specifications subject to
change without notice.