

Crestron **PROAMP(I)-7X400**
PROCISE™ High-Definition Professional
Surround Sound Amplifier

Operations Guide



This document was prepared and written by the Technical Documentation department at:



Crestron Electronics, Inc.
15 Volvo Drive
Rockleigh, NJ 07647
1-888-CRESTRON

Important Safety Instructions

- Read these instructions.
- Keep these instructions.
- Heed all warnings.
- Follow all instructions.
- Do not use this apparatus near water.
- Clean only with dry cloth.
- Do not block any ventilation openings. Install in accordance with the manufacturer's instructions.
- Do not install near any heat sources such as radiators, heat registers, stoves, or other apparatus (including amplifiers) that produce heat.
- Do not defeat the safety purpose of the polarized or grounding-type plug. A polarized plug has two blades with one wider than the other. A grounding-type plug has two blades and a third grounding prong. The wide blade or the third prong are provided for your safety. If the provided plug does not fit into your outlet, consult an electrician for replacement of the obsolete outlet.
- Protect the power cord from being walked on or pinched particularly at plugs, convenience receptacles, and the point where they exit from the apparatus.
- Only use attachments/accessories specified by the manufacturer.
- Use only with the cart, stand, tripod, bracket or table specified by the manufacturer or sold with the apparatus. When a cart is used, use caution when moving the cart/apparatus combination to avoid injury from tip-over. 
- Unplug this apparatus during lightning storms or when unused for long periods of time.
- Refer all servicing to qualified service personnel. Servicing is required when the apparatus has been damaged in any way, such as power-supply cord or plug is damaged, liquid has been spilled or objects have fallen into the apparatus, the apparatus has been exposed to rain or moisture, does not operate normally, or has been dropped.
- Disconnect power prior to connecting or disconnecting equipment.
- Do not install in direct sunlight.
- The apparatus must be installed in a way that the power cord can be removed either from the wall outlet or from the device itself in order to disconnect the mains power.
- Prevent foreign objects from entering the device.

WARNING:

TO REDUCE THE RISK OF FIRE OR ELECTRIC SHOCK, DO NOT EXPOSE THIS APPARATUS TO RAIN OR MOISTURE. THE APPARATUS SHALL NOT BE EXPOSED TO DRIPPING OR SPLASHING. OBJECTS FILLED WITH LIQUIDS, SUCH AS VASES, SHOULD NOT BE PLACED ON THE APPARATUS.

WARNING:

TO PREVENT ELECTRIC SHOCK, DO NOT REMOVE COVER. THERE ARE NO USER SERVICEABLE PARTS INSIDE. ONLY QUALIFIED SERVICE PERSONNEL SHOULD PERFORM SERVICE.



AVIS: RISQUE DE CHOC ELECTRIQUE NE PAS OUVRIR



The lightning flash with arrowhead symbol, within an equilateral triangle, is intended to alert the user to the presence of uninsulated "dangerous voltage" within the product's enclosure that may be of sufficient magnitude to constitute a risk of electric shock to persons.



The exclamation point within an equilateral triangle is intended to alert the user to the presence of important operating and maintenance (servicing) instructions in the literature accompanying the appliance.

WARNING:

THIS IS AN APPARATUS WITH CLASS I CONSTRUCTION. IT SHALL BE CONNECTED TO AN ELECTRICAL OUTLET WITH AN EARTHING GROUND TERMINAL.

IMPORTANT:

The PROAMP-7X400 and PROAMPI-7X400 can be used with Class 2 output wiring.

Regulatory Compliance

As of the date of manufacture, the PROAMP-7X400 and PROAMPI-7X400 have been tested and found to comply with specifications for CE marking and standards per EMC and Radiocommunications Compliance Labelling.



Federal Communications Commission (FCC) Compliance Statement

This device complies with part 15 of the FCC Rules. Operation is subject to the following conditions: (1) This device may not cause harmful interference and (2) this device must accept any interference received, including interference that may cause undesired operation.

CAUTION: Changes or modifications not expressly approved by the manufacturer responsible for compliance could void the user's authority to operate the equipment.

NOTE: This equipment has been tested and found to comply with the limits for a Class B digital device, pursuant to part 15 of the FCC Rules. These limits are designed to provide reasonable protection against harmful interference in a residential installation. This equipment generates, uses and can radiate radio frequency energy and, if not installed and used in accordance with the instructions, may cause harmful interference to radio communications. However, there is no guarantee that interference will not occur in a particular installation. If this equipment does cause harmful interference to radio or television reception, which can be determined by turning the equipment off and on, the user is encouraged to try to correct the interference by one or more of the following measures:

- Reorient or relocate the receiving antenna
- Increase the separation between the equipment and receiver
- Connect the equipment into an outlet on a circuit different from that to which the receiver is connected
- Consult the dealer or an experienced radio/TV technician for help

Industry Canada (IC) Compliance Statement

This Class B digital apparatus complies with Canadian ICES-003.

Cet appareil numérique de la classe B est conforme à la norme NMB-003 du Canada.

Contents

PROCISE™ High-Definition Professional Surround Sound Amplifier: PROAMP(I)-7X400	1
Introduction	1
Features and Functions	1
Applications.....	3
Specifications	4
Physical Description.....	5
Setup	10
Network Wiring.....	10
Identity Code	10
Installation.....	11
Hardware Hookup	12
Override Mode	15
Pairing	15
Programming Software.....	16
Earliest Version Software Requirements for the PC	16
Programming with Crestron SystemBuilder.....	16
Programming with SIMPL Windows	16
Example Program	18
Uploading and Upgrading.....	19
Establishing Communication.....	19
Programs and Firmware	20
Program Checks	20
Operation	22
Problem Solving	23
Troubleshooting.....	23
Check Network Wiring.....	23
Reference Documents.....	24
Further Inquiries	24
Future Updates	24
Return and Warranty Policies.....	25
Merchandise Returns / Repair Service	25
CRESTRON Limited Warranty.....	25

PROCISE™ High-Definition Professional Surround Sound Amplifier: PROAMP(I)-7X400

Introduction

The PROAMP-7X400 and PROAMPI-7X400 seven-channel amplifiers are the perfect complement to the PSPHD PROCISE High-Definition Professional Surround Sound Processor (sold separately), delivering 400 Watts per channel, with XLR balanced inputs, Cresnet® and Ethernet connectivity, and seamless control and monitoring through the PSPHD front panel.

The PROAMP-7X400 and PROAMPI-7X400 are functionally identical. For simplicity within this guide, the term “PROAMP-7X400” is used except where noted.

Features and Functions

- Professional 7-channel surround sound power amplifier
- 400 watts per channel at 8 Ohms
- Stable to 4 Ohms, all channels driven
- Perfect companion to the PSPHD PROCISE surround sound processor
- Affords native Creston® system integration via Ethernet or Cresnet
- Provides the benefits of Class D amplifiers with the neutral sound quality of Class AB amplifiers
- Infinitesimal noise and THD affords pure, natural audio reproduction
- Isolated channel power supplies ensure maximum dynamic impact
- DC coupling affords transparency and frequency response
- Inrush current limiting provides for gentle power-up
- Includes front panel signal, clip, and fault indicators for each channel
- Allows expanded monitoring of temperature, faults, and signal status from PSPHD or control system
- Heavy duty detachable terminal blocks ease speaker wire termination
- 24k gold-plated XLR balanced inputs assure optimum signal transfer
- Premium 7-channel XLR interconnect kits available
- Includes optional rack ears and front/rear lifting handles
- Five-space 19" rack-mountable

The Power to Inspire

The PROAMP-7X400's custom hybrid design achieves the warmth and neutrality of a Class AB amplifier with all the efficiency benefits of modern Class D.

The PROAMP-7X400 delivers 400 Watts at 8 Ohms, and 700 Watts at 4 Ohms, per channel. Twin 1.8 kVA toroidal power transformers direct pure, continuous power to its seven mono amplifier channels, each with its own isolated power supply featuring an immense 168,000 μ F total capacitance for wide dynamic range and headroom.

Efficiency

An ultra-efficient circuit and chassis design enables the PROAMP-7X400 to produce greater output power in considerably less space compared to other amplifiers. The PROAMP-7X400 accomplishes its class-leading performance in a mere five rack spaces while maintaining effective cooling with no need for extra clearance above or below.

Pairing

Together, the PROAMP-7X400 and PSPHD processor possess the unique ability to operate as one, affording functionality unattainable from any other amp/preamp combination. Through a simple Ethernet connection, the two components become paired, enabling seamless control and monitoring of the amplifier through the PSPHD's front panel. While the PROAMP-7X400 provides indication of signal and fault conditions on its own faceplate, you can actually confirm the specific fault condition, check the real internal temperature, and monitor the output level of each amp channel on the face of the PSPHD. Pairing the two components also streamlines remote control and monitoring through a Crestron control system, providing programmers with a unified device interface for all functions.

Protect, Monitor, Control

To help ensure the most seamless user experience and long-lived operation from your amplifier, the PROAMP-7X400 provides several ways to assume control of its essential functions and keep tabs of its operating status and health. On its own, the PROAMP-7X400 possesses the intelligence to protect itself from many types of faults including over temperature, over current, over voltage, under voltage, and DC offset on any channel. Its front panel indicators help alert the user to any fault condition, and provide verification of signal activity and clipping. More detailed status monitoring is available when paired with a PSPHD processor.

For the greatest flexibility, the PROAMP-7X400 includes both Cresnet and high-speed Ethernet to enable direct control and monitoring via a Crestron control system (in lieu of a PSPHD). Whether communicating with the control system directly or via a PSPHD, the PROAMP-7X400 lets you control amplifier power, mute individual channels, monitor temperature and signal status, and receive fault alerts, all from a Crestron touchpanel, computer or mobile device. Signals from the amplifier may also be utilized to enable custom automation, such as reducing audio levels when clipping is sensed, or regulating climate control in the equipment room in response to amp temperature.

Professional & Precise

The PROAMP-7X400 is designed to produce pristine, accurate audio. A hybrid, DC coupled topology preserves the audio signal throughout without coloring or adding noise.

Applications

The following diagram shows a PROAMP-7X400 in a residential application.

PROAMP-7X400 in a Home Theater Application

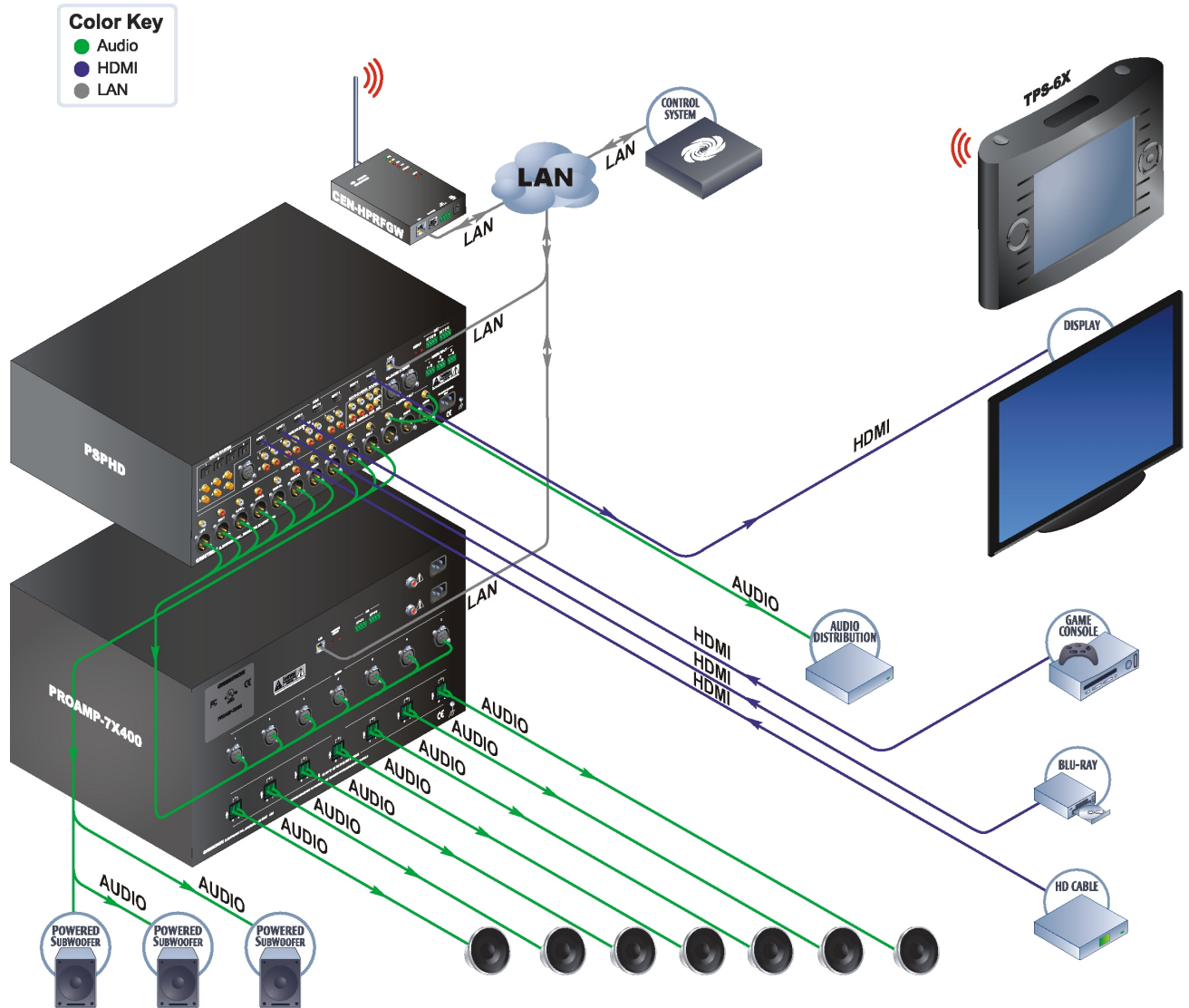

Specifications

Specifications for the PROAMP-7X400 are listed in the following table.

PROAMP-7X400 Specifications

SPECIFICATION	DETAILS
Audio (Typical of 7 Mono Channels)	
Output Power	400 Watts per channel at 8 Ohms 700 Watts per channel at 4 Ohms
Power Bandwidth	5 Hz – 45 kHz at -3 dB
Damping Factor	> 250
Frequency Response	20 Hz to 20 kHz, ± 0.1 dB
S/N Ratio	117 dB, A-weighted
Total Harmonic Distortion (THD)	0.02%
Intermodulation Distortion (IMD)	0.05%
Crosstalk	105 dB
Gain	23 dB
Input Sensitivity	4 V_{rms} produces 400 watts into 8 ohms
Main Power	2 x 12 Amps @ 120 Volts AC, 60 Hz; Requires two independent 15 Amp circuits
Default Net ID	9C
Minimum 2-Series Control System Update File ^{1,2}	Version 4.001.1012 or later
Environmental	
Temperature	41° to 104°F (5° to 40°C)
Humidity	10% to 90% RH (non-condensing)
Heat Dissipation (at 1/8 full power)	At 8 Ohms: 650 BTU/Hr At 4 Ohms: 1100 BTU/Hr
Enclosure	
Chassis	Metal, vented sides, ultra-quiet speed-controlled fan cooling
Front Panel	Aluminum with plastic overlay
Mounting	Freestanding or 5U 19-inch rack-mountable (detachable feet, rack ears, and handles are pre-installed)
Dimensions	
Height	9.24 in (235 mm) with feet 8.70 in (221 mm) without feet
Width	19.00 in (483 mm) with ears 17.28 in (439 mm) without ears
Depth	21.14 in (537 mm) with front & rear handles 18.36 in (467 mm) without handles
Weight (including rack ears, front handles, & rear handles)	108 lbs (49 kg)

(Continued on following page)

PROAMP-7X400 Specifications (Continued)

SPECIFICATION	DETAILS
Available Accessories	
CBL-PRO-XLR-2	Balanced Audio Interface Cable Kit (two-foot cable length)
CBL-PRO-XLR-6	Balanced Audio Interface Cable Kit (six-foot cable length)
PSPHD	PROCISE™ High-Definition Professional Surround Sound Processor

1. The latest software versions can be obtained from the Crestron website. Refer to the NOTE following these footnotes.
2. Crestron 2-Series control systems include the AV2 and PRO2. Consult the latest Crestron Product Catalog for a complete list of 2-Series control systems.

NOTE: Crestron software and any files on the website are for authorized Crestron dealers and Crestron Authorized Independent Programmers (CAIP) only. New users may be required to register to obtain access to certain areas of the site (including the FTP site).

Physical Description

This section provides information on the connections, controls and indicators available on your PROAMP-7X400.

PROAMP-7X400 Physical View (Front)





PROAMP-7X400 Physical View (Rear)

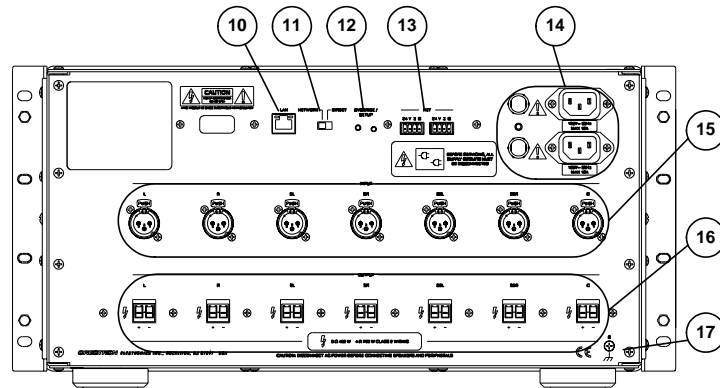
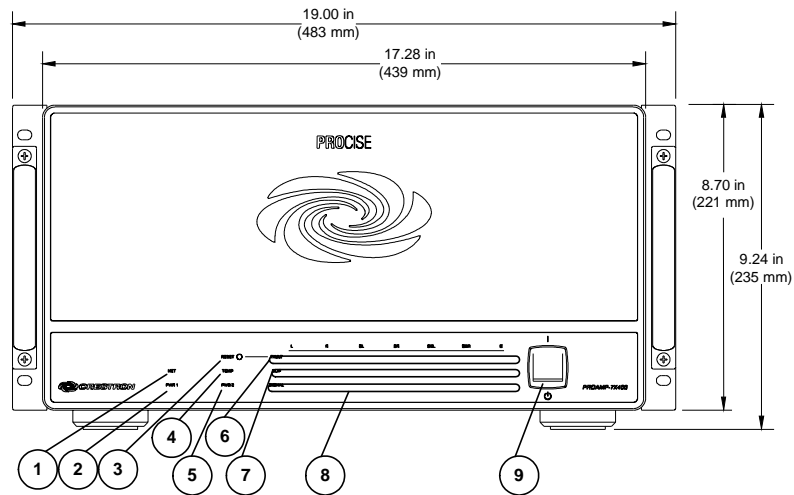
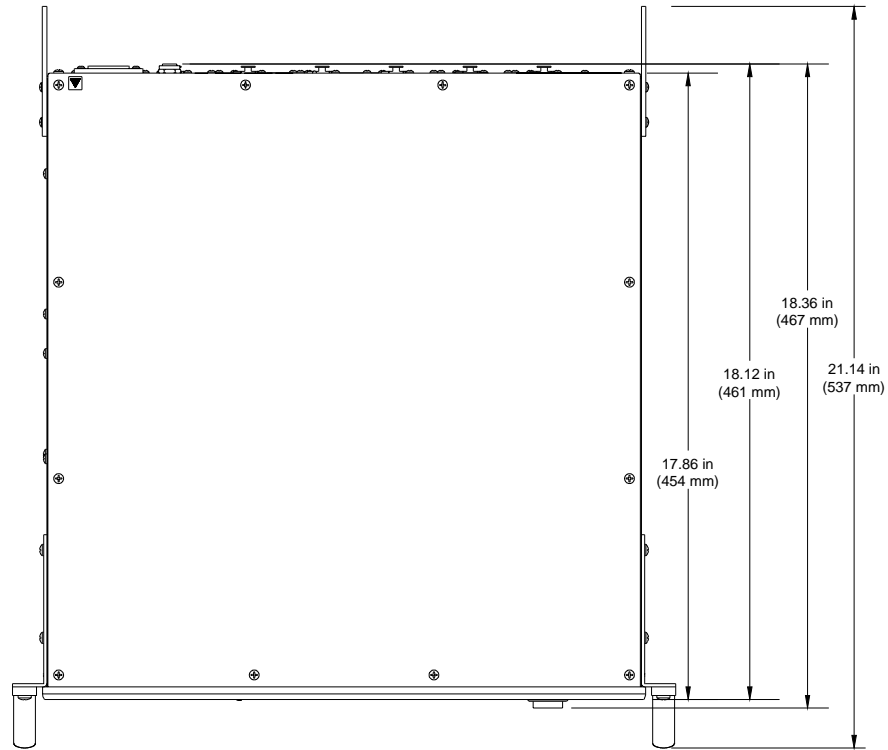

PROAMP-7X400 Overall Dimensions





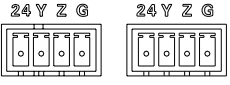

Connectors, Controls & Indicators

#	CONNECTORS*, CONTROLS & INDICATORS	DESCRIPTION
1	NET LED	(1) Amber LED, indicates communication with Cresnet system
2	PWR 1 LED	(1) Green LED, indicates power switch is enabled and power is present at the upper power input
3	RESET BUTTON	(1) Miniature pushbutton, clears all channel fault indications if condition is resolved
4	TEMP LED	(1) Red LED, indicates an over-temperature condition
5	PWR 2 LED	(1) green LED, indicates power switch is enabled and power is present at the lower power input
6	FAULT LEDS	(7) Red LEDs; indicate over-temperature, over-current, over or under power supply voltage, or DC offset condition on the corresponding channel
7	CLIP LEDS	(7) Amber LEDs, indicate a clipping condition on the corresponding channel
8	SIGNAL LEDS	(7) Green LEDs, indicate signal presence on the corresponding channel
9	POWER	(1) Toggle switch, removes power from the amp and resets microprocessor
10	LAN 	(1) 8-wire RJ-45 with 2 LED indicators; 10/100BaseT Ethernet port; Green LED indicates link status; Amber LED indicates Ethernet activity; Straight-thru LAN cable included for direct connection to PSPHD
11	NETWORK/DIRECT NETWORK DIRECT 	(1) Slide switch, selects whether connection to PSPHD is via LAN or direct connection
12	VERRIDE/SETUP (LED and button) VERRIDE / SETUP 	(1) miniature pushbutton and (1) red LED, used for touch-settable ID (TSID) in conjunction with Crestron Toolbox™ software, for activating <i>Override</i> mode for testing, and for pairing with PSPHD
13	NET 	(2) 4-pin 3.5mm detachable terminal blocks; Cresnet slave ports, paralleled; 24: Power (24 Volts DC) Y: Data Z: Data G: Ground NOTE: The NET port does not supply or consume power.

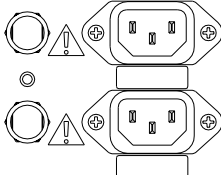
(Continued on following page)

Connectors, Controls & Indicators (Continued)

#	CONNECTORS*, CONTROLS & INDICATORS	DESCRIPTION
14	<p style="text-align: center;">POWER INPUT</p> 	<p>(2) IEC C14 male chassis plugs, main power inputs 1 & 2; Mate with removable power cords (included); Each input includes a 15 Amp circuit breaker (PROAMPI-7X400 has 8 Amp breakers); Requires two independent AC feeds</p>
15	<p style="text-align: center;">INPUT</p> 	<p>(7) 3-pin XLR female; Balanced line-level audio inputs; Input Impedance: 24k Ohms balanced; Maximum Input Level: 4 V_{rms} balanced</p>
16	<p style="text-align: center;">OUTPUT</p> 	<p>(7) 2-pin 7.62mm 41A detachable terminal blocks; Power amplifier outputs; Wire Size: Terminals accept up to 10 AWG</p>
17	<p style="text-align: center;">GROUND</p> 	<p>(1) 6-32 screw, chassis ground lug</p>

* Interface connectors for the **NET** and **OUTPUT** ports are provided with the unit.

Setup

Network Wiring

When wiring the Cresnet and Ethernet network, consider the following:

- Use Crestron Certified Wire.
- Use Crestron power supplies for Crestron equipment.
- Provide sufficient power to the system.

CAUTION: Insufficient power can lead to unpredictable results or damage to the equipment. Please use the Crestron Power Calculator to help calculate how much power is needed for the system (www.crestron.com/calculators).

Cresnet

For networks with 20 or more devices, use a Cresnet Hub/Repeater (CNXHUB) to maintain signal quality.

For more details, refer to “Check Network Wiring” on page 23.

Ethernet

The PROAMP-7X400 can also use high-speed Ethernet for communications between the device and a control system, computer, digital media server and other IP-based devices.

For information on connecting Ethernet devices in a Crestron system, refer to the latest version of the Crestron e-Control® Reference Guide (Doc. 6052), which is available from the Crestron website (www.crestron.com/manuals).

Identity Code

Net ID

The Net ID of the PROAMP-7X400 has been factory set to **9C**. The Net IDs of multiple PROAMP-7X400 devices in the same system must be unique. Net IDs are changed from a personal computer (PC) via Crestron Toolbox™ (refer to “Establishing Communication” on page 19).

When setting the Net ID, consider the following:

- The Net ID of each unit must match an ID code specified in the SIMPL™ Windows program.
- Each network device must have a unique Net ID.
- If an IP ID is set, Cresnet communication with the PSPHD is disabled. The PROAMP-7X400 can use either a Cresnet connection or Ethernet connection. It cannot use both.

For more details, refer to the Crestron Toolbox help file.

IP ID

The IP ID is set within the PROAMP-7X400’s table using Crestron Toolbox. For information on setting an IP table, refer to the Crestron Toolbox help file. The IP IDs of multiple PROAMP-7X400 devices in the same system must be unique.

When setting the IP ID, consider the following:

- The IP ID of each unit must match an IP ID specified in the SIMPL Windows program.
- Each device using IP to communicate with a control system must have a unique IP ID.

- If an IP ID is set, Cresnet communication with the PSPHD is disabled. The PROAMP-7X400 can use either a Cresnet connection or Ethernet connection. It cannot use both.

Installation

Observe the following guidelines when installing the PROAMP-7X400:

WARNING: Failure to observe the following installation guidelines may result in personal injury or damage to the equipment.

- The PROAMP-7X400 is very heavy. Two people should lift and install the device.
- The installation location must be able to support the weight of the PROAMP-7X400 (108 lbs (49.0 kg)).

Ventilation

The PROAMP-7X400 should be used in a well-ventilated area. The venting holes should not be obstructed under any circumstances.

To prevent overheating, do not operate this product in an area that exceeds the environmental temperature range listed in the table of specifications. Consider using forced air ventilation and/or incrementing the spacing between units to reduce overheating. Consideration must be given if installed in a closed or multi-unit rack assembly since the operating ambient temperature of the environment may be greater than the room ambient temperature. Contact with thermal insulating materials should be avoided on all sides of the unit.

Rack Mounting

The PROAMP-7X400 can be mounted in a rack or stacked with other equipment. Two “ears” are preinstalled so that the unit can be mounted in a rack.

WARNING: To prevent bodily injury when mounting or servicing this unit in a rack, take special precautions to ensure that the system remains stable. The following guidelines are provided to ensure your safety:

- Load the rack from the bottom to the top with the heaviest component at the bottom of the rack.
- If the rack is provided with stabilizing devices, install the stabilizers before mounting or servicing the unit in the rack.

NOTE: The PROAMP-7X400 is shipped with “feet” installed so it can be stacked with other equipment. If the PROAMP-7X400 is to be installed in a rack, remove the feet using a #2 Phillips screwdriver. If rack mounting is not required, leave the feet attached to the PROAMP-7X400.

NOTE: Reliable earthing of rack-mounted equipment should be maintained. Particular attention should be given to supply connections other than direct connections to the branch circuit (e.g. use of power strips).

Use the following procedure and a #1 or #2 Philips screwdriver to install the PROAMP-7X400 into a rack. Refer to the following illustration.

Rack Attachment for Rack Mounting

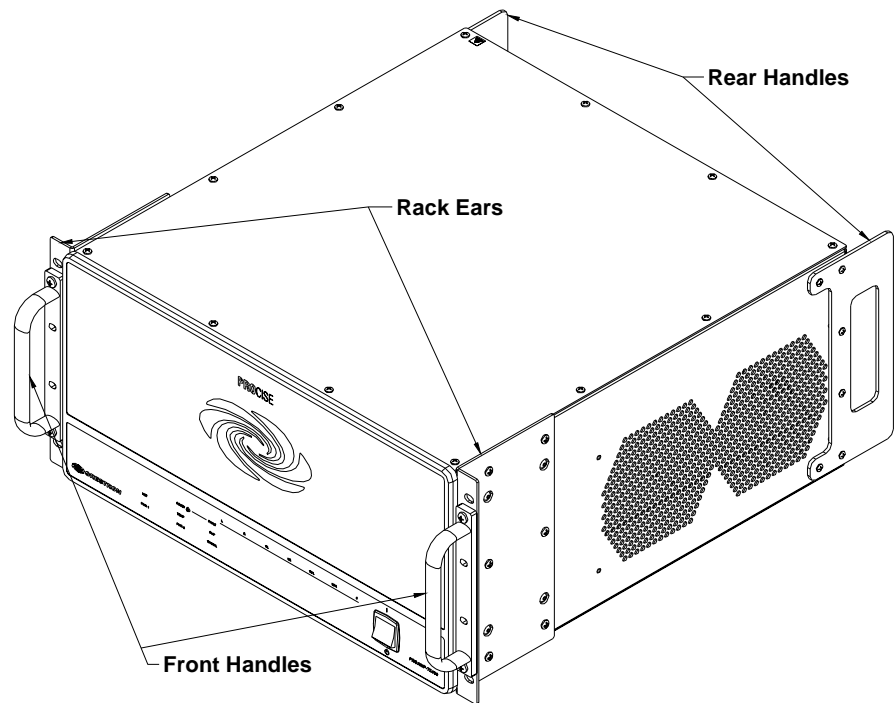

1. Remove the feet on the bottom of the amplifier.
2. Position the amplifier into the rack and secure the device to the rack by screwing four rack screws (not included) into the top and bottom mounting holes of the rack ears.
3. Remove the front handles.
4. Secure the amplifier to the rack by installing four more screws (not included) into the middle mounting holes of the rack ears.
5. (Optional) Remove the rear handles.

Stacking

Four “feet” are integrated into the PROAMP-7X400 so that if the unit is not rack mounted, the feet can provide stability when the unit is placed on a flat surface or stacked.

NOTE: No more than two PROAMP-7X400 units should be stacked.

Hardware Hookup

Connect the Device

Make the necessary connections as called out in the illustration that follows this paragraph. Refer to “Network Wiring” on page 10 before attaching the 4-position terminal block connector. Apply power after all connections have been made.

WARNING: This amplifier is capable of delivering immense amounts of undistorted power to your loudspeakers. Please use caution and adequate ear protection if listening to content at high volume levels as continued exposure to high sound pressure levels can cause permanent hearing impairment or loss.

CAUTION: Keep the amplifier unplugged until all the input, network, and speaker wiring is complete.

CAUTION: Do not bridge speaker outputs.

CAUTION: Check the speaker wires for shorts and frayed wiring around the **OUTPUT** connectors.

NOTE: For optimum performance, Crestron recommends the optional CBL-PRO-XLR-2 XLR Balanced Audio Interface Cable Kit (two-foot cable length) or CBL-PRO-XLR-6 Balanced Audio Interface Cable Kit (six-foot cable length) to connect to the PSPHD or other pre-amplifier.

Hardware Connections for the PROAMP-7X400

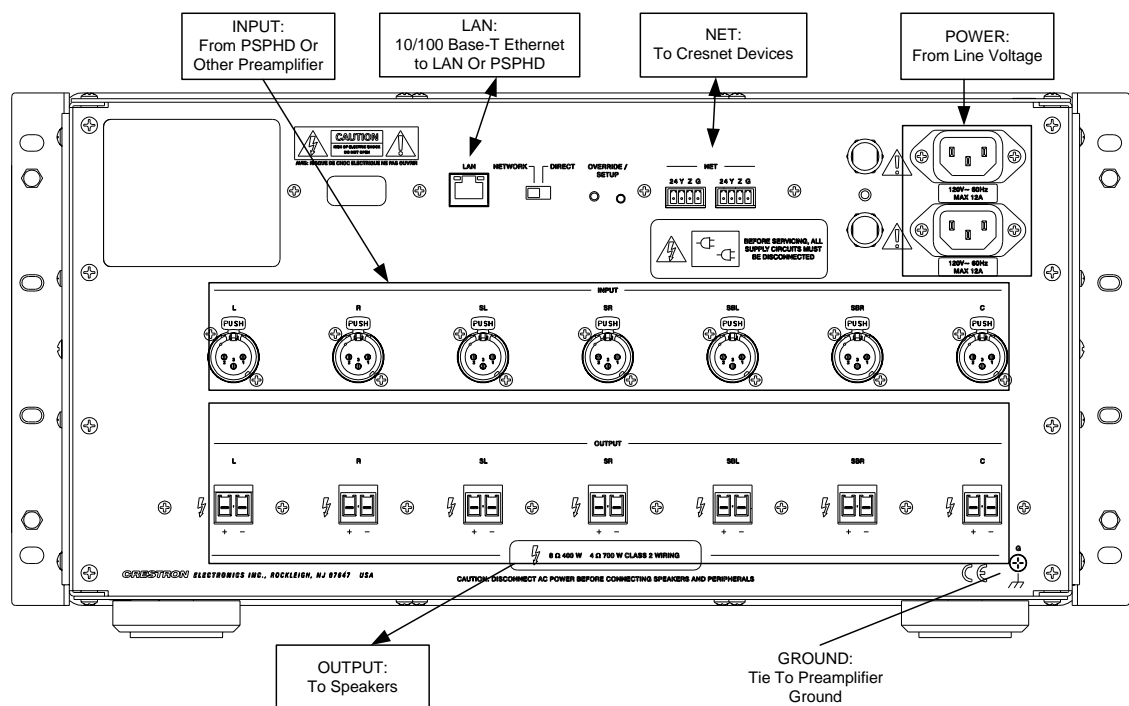

NETWORK/DIRECT Switch

The **NETWORK/DIRECT** switch is used to select the connection between the amplifier and a PSPHD. Move the switch to the appropriate position for the connection to be used and connect the **LAN** port as described below:

- **DIRECT:** If using a direct connection to the PSPHD, connect an Ethernet cable from the **LAN** port on the amplifier to the **LAN** port on a PSPHD.
- **NETWORK:** If using a network connection to the PSPHD, connect an Ethernet cable from the **LAN** port on the amplifier to the local area network. When using a network connection, the PSPHD and the amplifier must be on the same subnet.

NOTE: Power must be cycled if the switch is moved.

For more information, refer to “Pairing” on page 15.

PROCISE Amplifier Connections

Refer to the following diagram to properly connect the PROAMP-7X400 to a PSPHD Surround Sound Processor.

Connect a PROAMP-7X400 to a PSPHD Surround Sound Processor

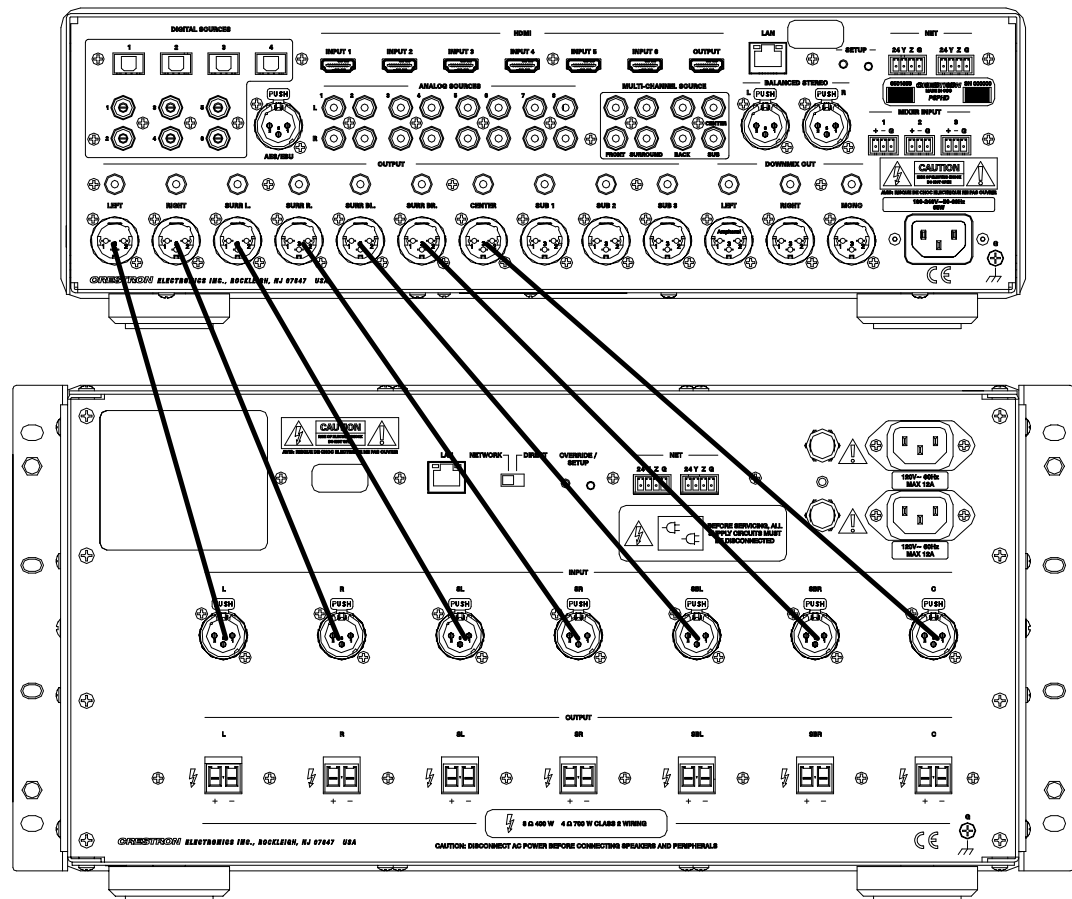

NOTE: For optimum performance when connecting a source to a PROCISE amplifier, Crestron recommends the optional CBL-PRO-XLR-2 Balanced Audio Interface Cable Kit (two-foot cable length) or CBL-PRO-XLR-6 Balanced Audio Interface Cable Kit (six-foot cable length).

Power Connections

When making connections to the PROAMP-7X400, two independent AC feeds are required.

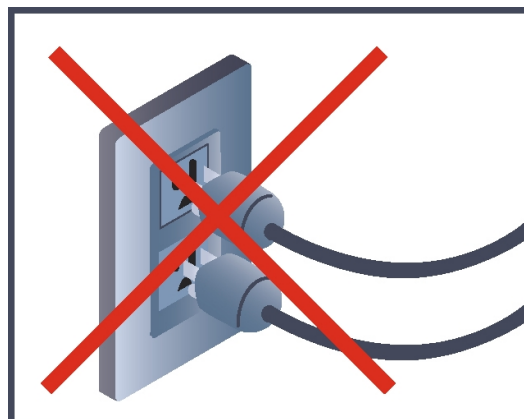

Override Mode

The *Override* mode turns on all amplifier channels and ignores any commands from a control system or PSPHD (if connected). Use the *Override* mode to test the amplifier prior to installation in a system. To use the *Override* mode:

1. With the amplifier powered on, press the **OVERRIDE/SETUP** button on the rear of the PROAMP-7X400. The amplifier will be in the *Override* mode and the associated LED will light.
2. Test the amplifier as needed.
3. Press **OVERRIDE/SETUP** to exit the *Override* mode. The LED will extinguish.

Pairing

NOTE: Pairing is for use with the PSPHD only.

The PROAMP-7X400 can be paired with a PSPHD Surround Sound Processor for control and monitoring of the amplifier. Use the connection type that best fits the application:

- **DIRECT:** Choose **DIRECT** for a quick installation test without networking or LAN setup. The **LAN** port of the amplifier connects directly to the **LAN** port of the PSPHD.

The following diagram shows a typical system arrangement where a PSPHD is directly connected to the amplifier.

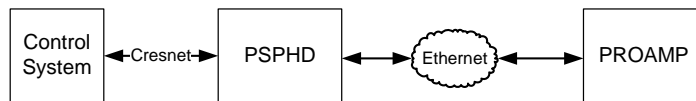

To later integrate with a control system program controlling via the LAN, the pairing process must be executed again when the amplifier is installed on a network. The original pairing must be removed and then re-paired.

If the amplifier and PSPHD are to be controlled by Cresnet, pairing does not need to be repeated.

- **NETWORK:** Choose **NETWORK** if you already have a DHCP network available and plan to eventually control the amplifier and PSPHD over a LAN.

The following diagram shows a typical system arrangement where a PSPHD is connected to the amplifier over an Ethernet network.

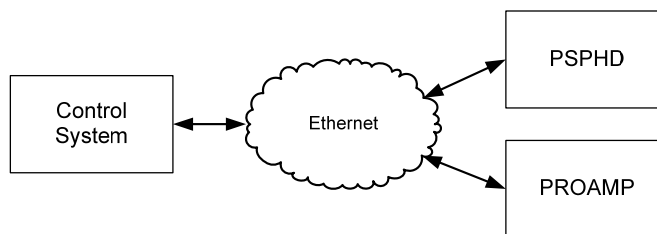

For details on pairing the PROAMP-7X400 with a PSPHD, refer to the latest version of the PROAMP-7X400 Quickstart (Doc. 6977) and the PSPHD Operations Guide (Doc. 6837) which are available for download from the Crestron website.

Programming Software

Have a question or comment about Crestron software?

Answers to frequently asked questions (FAQs) can be viewed in the Online Help section of the Crestron website. To post a question or view questions you have submitted to Crestron's True Blue Support, log in at www.crestron.com/support. First-time users will need to establish a user account.

Earliest Version Software Requirements for the PC

NOTE: Crestron recommends that you use the latest software to take advantage of the most recently released features. The latest software is available from the Crestron website.

Crestron has developed an assortment of Windows®-based software tools to develop a controlled system. You can create a program to control the PROAMP-7X400 using the Crestron programming tools SystemBuilder™ or SIMPL Windows. For the minimum recommended software versions, visit the Version Tracker page of the Crestron website (www.crestron.com/versiontracker).

Programming with Crestron SystemBuilder

Crestron SystemBuilder is the easiest method of programming but does not offer as much flexibility as SIMPL Windows. For additional details, download SystemBuilder from the Crestron website and examine the extensive help file.

Programming with SIMPL Windows

NOTE: While SIMPL Windows can be used to program the PROAMP-7X400, it is recommended to use SystemBuilder.

SIMPL Windows is Crestron's premier software for programming Crestron control systems. It is organized into two separate but equally important "Managers".

Configuration Manager

Configuration Manager is the view where programmers "build" a Crestron control system by selecting hardware from the *Device Library*.

NOTE: When paired with a PSPHD, the amplifier does not need to be added to the SIMPL Windows program. Adding the amplifier to the program is recommended when a paired PSPHD is not present in the system.

1. The PROAMP-7X400 must first be incorporated into the system.
 - a. To incorporate the PROAMP-7X400 (Cresnet) into the system, drag the PROAMP-7X400 from the Cresnet Control Modules | Cresnet Audio Modules folder of the *Device Library* and drop it in the *System Views*.

Locating the PROAMP-7X400 (Cresnet) in the Device Library

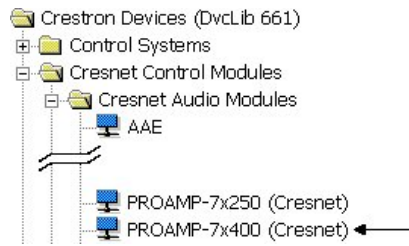

- b. To incorporate the PROAMP-7X400 (Ethernet) into the system, drag the PROAMP-7X400 from the Ethernet Control Modules | Ethernet Audio Modules folder of the *Device Library* and drop it in the *System Views*.

Locating the PROAMP-7X400 (Ethernet) in the Device Library

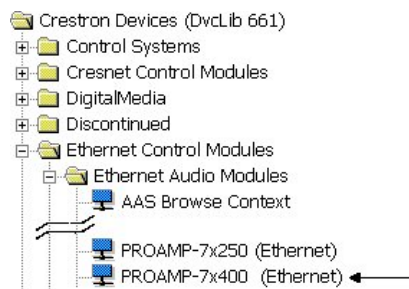

- 2. The system tree of the control system displays the device in the appropriate slot(s) with a default Net ID or IP ID as shown in the following illustration.

NOTE: In the following illustration, there is both an Ethernet device in Slot 8 and a Cresnet device in Slot 9. It is possible to have both types of device attached to a control system as long as the control system has either a built-in or expansion Ethernet interface. If Cresnet operation is desired, the IP table for the PROAMP-7X400 must be empty.

PROAMP-7X400 Device, Slots 8 and 9

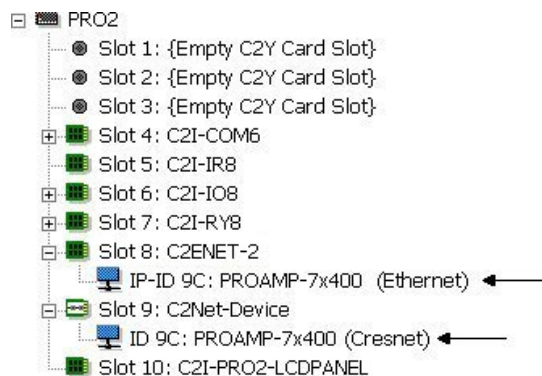

- 3. Additional PROAMP-7X400 devices are assigned different Net ID or IP ID numbers as they are added.

- If necessary, double click a device to open the “Device Settings” window and change the Net ID or IP ID, as shown in the following figures.

“Device Settings: Crestron PROAMP-7X400 (Cresnet)” Window

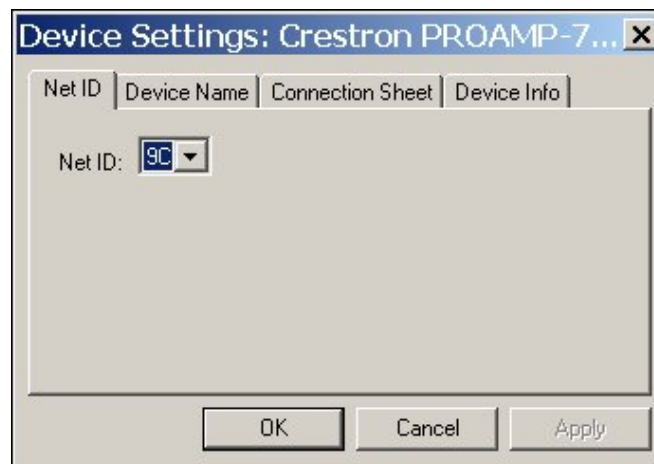

“Device Settings: Crestron PROAMP-7X400 (Ethernet)” Window

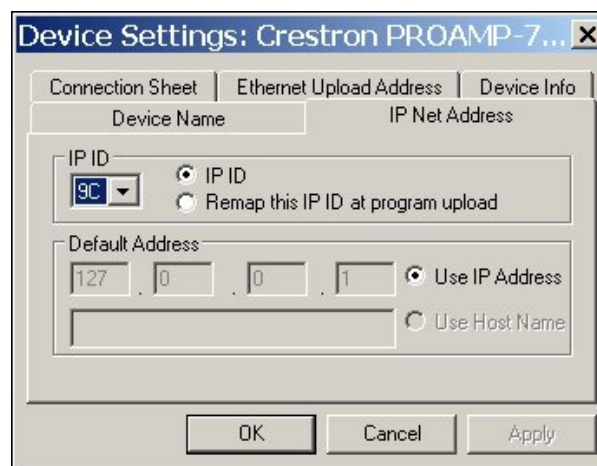

- The ID code specified in the SIMPL Windows program must match the Net ID or IP ID of each unit. Refer to “Identity Code” on page 10.

Program Manager

Program Manager is the view where programmers “program” a Crestron control system by assigning signals to symbols.

The symbol can be viewed by double clicking on the icon or dragging it into *Detail View*. Each signal in the symbol is described in the SIMPL Windows help file (**F1**).

Example Program

An example program for the PROAMP-7X400 is available from the Crestron website (www.crestron.com/exampleprograms).

Uploading and Upgrading

Crestron recommends using the latest programming software and that each device contains the latest firmware to take advantage of the most recently released features. However, before attempting to upload or upgrade it is necessary to establish communication. Once communication has been established, files (for example, programs or firmware) can be transferred to the control system (and/or device). Finally, program checks can be performed (such as changing the device ID or creating an IP table) to ensure proper functioning.

Establishing Communication

Use Crestron Toolbox for communicating with the PROAMP-7X400; refer to the Crestron Toolbox help file for details. There are two methods of communication.

Indirect

Indirect Communication

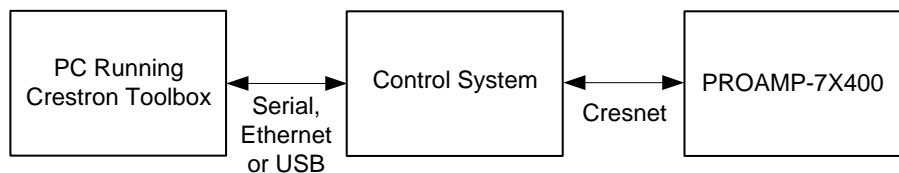

PROAMP-7X400 connects to control system via Cresnet:

1. Establish communication between the PC and the control system as described in the latest version of the 2-Series Control Systems Reference Guide (Doc. 6256).
2. Use the Address Book in Crestron Toolbox to create an entry for the PROAMP-7X400 using the expected communication protocol (indirect). Select the Cresnet ID of the PROAMP-7X400 and the address book entry of the control system that is connected to the PROAMP-7X400.
3. Display the PROAMP-7X400's "System Info" window (click the  icon); communications are confirmed when the device information is displayed.

TCP/IP

NOTE: Required for operation with a PSPHD.

Ethernet Communication

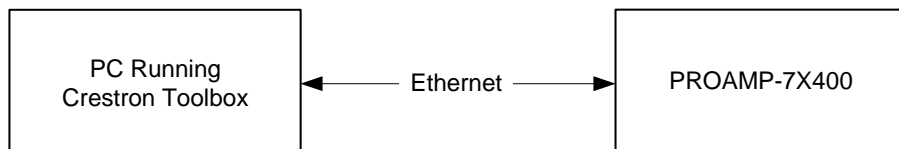

NOTE: If the PROAMP-7X400 is connected directly to the PSPHD and the **NETWORK/DIRECT** switch is set to **DIRECT**, the IP address is 192.168.238.239. If the PROAMP-7X400 is connected to a LAN, DHCP is enabled. Use the Device Discovery Tool in Crestron Toolbox to detect all Ethernet devices on the network and their IP configuration. The tool is available in Toolbox version 1.15.143 or later.

The PROAMP-7X400 connects to PC via Ethernet:

1. Enter the IP address, IP mask and default router of the PROAMP-7X400 via Crestron Toolbox (**Functions | Ethernet Addressing**); otherwise enable DHCP.
2. Confirm Ethernet connection between PROAMP-7X400 and PC. If connecting through a hub or router, use CAT5 straight through cables with 8-pin RJ-45 connectors. Alternatively, use a CAT5 crossover cable to connect the two LAN ports directly without using a hub or router.
3. Use the Address Book in Crestron Toolbox to create an entry for the PROAMP-7X400 with the PROAMP-7X400's TCP/IP communication parameters.
4. Display the "System Info" window (click the  icon) and select the PROAMP-7X400 entry.

Programs and Firmware

Program or firmware files may be distributed from programmers to installers or from Crestron to dealers. Firmware upgrades are available from the Crestron website as new features are developed after product releases. One has the option to upload programs via the programming software or to upload and upgrade via the Crestron Toolbox. For details on uploading and upgrading, refer to the SIMPL Windows help file or the Crestron Toolbox help file.

SIMPL Windows

If a SIMPL Windows program is provided, it can be uploaded to the control system using SIMPL Windows or Crestron Toolbox.

Firmware

Check the Crestron website to find the latest firmware. (New users may be required to register to obtain access to certain areas of the site, including the FTP site.)

Upgrade PROAMP-7X400 firmware via Crestron Toolbox.

1. Establish communication with the PROAMP-7X400 and display the "System Info" window.
2. Select **Functions | Firmware...** to upgrade the PROAMP-7X400 firmware.

Program Checks

Actions that can be performed on the PROAMP-7X400 vary depending on whether it is connected via Cresnet or Ethernet.

Cresnet Connections

For Cresnet connections, using Crestron Toolbox, display the network device tree (**Tools | Network Device Tree**) to show all network devices connected to the control system. Right-click on the PROAMP-7X400 to display actions that can be performed on the PROAMP-7X400.

Ethernet Connections

For Ethernet connections, using Crestron Toolbox, display the "System Info window (click the  icon) and select the **Functions** menu to display actions that can be performed on the PROAMP-7X400.

Be sure to use Crestron Toolbox to create the PROAMP-7X400 IP table.

1. Select **Functions | IP Table Setup**.
2. Add, modify or delete entries in the IP table. The PROAMP-7X400 can have only one IP table entry.
3. A defined IP table can be saved to a file or sent to the device.

Edit the control system's IP table to include an entry for the PROAMP-7X400. The entry should list the PROAMP-7X400's IP ID (specified on the PROAMP-7X400's IP table) and the internal gateway IP address 127.0.0.1.

Operation

Turn Power On or Off

To turn the amplifier power on, move the switch on the front of the amplifier to the **I** position.

To turn the power off, move the switch on the front of the amplifier to the  position. The amplifier's microprocessor will reset and continue to receive power.

Clear Fault Indicator

In the event a channel detects overcurrent, over/under voltage, channel temperature, or DC offset voltage, its **FAULT** LED will light. To clear the **FAULT** LED, press the recessed **RESET** button on the front of the amplifier.

NOTE: Before pressing **RESET**, verify that the cause of the fault is no longer present.

Reset Circuit Breaker

The amplifier is equipped with two circuit breakers that will open in the event an internal short is detected. To reset a breaker, turn off the amplifier power as described above, then press the breaker's reset button on the rear of the amplifier.

NOTE: Before resetting the breaker, verify that the cause of the short is no longer present.

Problem Solving

Troubleshooting

The following table provides corrective action for possible trouble situations. If further assistance is required, please contact a Crestron customer service representative.

PROAMP-7X400 Troubleshooting

TROUBLE	POSSIBLE CAUSE(S)	CORRECTIVE ACTION
Device does not function.	Device is not communicating with the network.	Use Crestron Toolbox to poll the network. Verify network connection to the device.
	Device is not paired with a PSPHD.	Pair the amplifier with a PSPHD.
Device does not respond to program control.	Device is in the <i>Override</i> mode.	Press OVERRIDE/SETUP to exit the <i>Override</i> mode.
TEMP LED illuminates.	Excessive temperature inside amplifier.	Provide better ventilation to amplifier.
FAULT LED illuminates.	DC offset voltage on speaker terminal.	Remove DC source from input signal. Press RESET to turn off FAULT LED .
	Driving source level is too high.	Lower output level of audio source. Press RESET to turn off FAULT LED .
	Operating temperature is too high.	Provide better ventilation to amplifier.
	Both power plugs are plugged into outlet on the same circuit.	Each power cord must be plugged into a different circuit.
	Device is not receiving sufficient power.	Verify that each power cord is plugged into a separate circuit.

Check Network Wiring

Use the Right Wire

In order to ensure optimum performance over the full range of your installation topology, Crestron Certified Wire and only Crestron Certified Wire may be used. Failure to do so may incur additional charges if support is required to identify performance deficiencies because of using improper wire.

Strip and Tin Wire

When daisy-chaining Cresnet units, strip the ends of the wires carefully to avoid nicking the conductors. Twist together the ends of the wires that share a pin on the network connector and tin the twisted connection. Apply solder only to the ends of the twisted wires. Avoid tinning too far up the wires or the end becomes brittle. Insert the tinned connection into the Cresnet connector and tighten the retaining screw. Repeat the procedure for the other three conductors.

Add Hubs

Use of a Cresnet Hub/Repeater (CNXHUB) is advised whenever the number of Cresnet devices on a network exceeds 20 or when the combined total length of Cresnet cable exceeds 3000 feet (914 meters).

Reference Documents

The latest version of all documents mentioned within the guide can be obtained from the Crestron website (www.crestron.com/manuals). This link will provide a list of product manuals arranged in alphabetical order by model number.

List of Related Reference Documents

DOCUMENT TITLE
2-Series Control Systems Reference Guide
Crestron e-Control Reference Guide
PSPHD PROCISE™ High Definition Professional Surround Sound Processor

Further Inquiries

If you cannot locate specific information or have questions after reviewing this guide, please take advantage of Crestron's award winning customer service team by calling Crestron at 1-888-CRESTRON [1-888-273-7876].

You can also log onto the online help section of the Crestron website (www.crestron.com/onlinehelp) to ask questions about Crestron products. First-time users will need to establish a user account to fully benefit from all available features.

Future Updates

As Crestron improves functions, adds new features and extends the capabilities of the PROAMP-7X400, additional information may be made available as manual updates. These updates are solely electronic and serve as intermediary supplements prior to the release of a complete technical documentation revision.

Check the Crestron website periodically for manual update availability and its relevance. Updates are identified as an “Addendum” in the Download column.

Return and Warranty Policies

Merchandise Returns / Repair Service

1. No merchandise may be returned for credit, exchange or service without prior authorization from CRESTRON. To obtain warranty service for CRESTRON products, contact an authorized CRESTRON dealer. Only authorized CRESTRON dealers may contact the factory and request an RMA (Return Merchandise Authorization) number. Enclose a note specifying the nature of the problem, name and phone number of contact person, RMA number and return address.
2. Products may be returned for credit, exchange or service with a CRESTRON Return Merchandise Authorization (RMA) number. Authorized returns must be shipped freight prepaid to CRESTRON, 6 Volvo Drive, Rockleigh, N.J. or its authorized subsidiaries, with RMA number clearly marked on the outside of all cartons. Shipments arriving freight collect or without an RMA number shall be subject to refusal. CRESTRON reserves the right in its sole and absolute discretion to charge a 15% restocking fee plus shipping costs on any products returned with an RMA.
3. Return freight charges following repair of items under warranty shall be paid by CRESTRON, shipping by standard ground carrier. In the event repairs are found to be non-warranty, return freight costs shall be paid by the purchaser.

CRESTRON Limited Warranty

CRESTRON ELECTRONICS, Inc. warrants its products to be free from manufacturing defects in materials and workmanship under normal use for a period of three (3) years from the date of purchase from CRESTRON, with the following exceptions: disk drives and any other moving or rotating mechanical parts, pan/tilt heads and power supplies are covered for a period of one (1) year; touchscreen display and overlay components are covered for 90 days; batteries and incandescent lamps are not covered.

This warranty extends to products purchased directly from CRESTRON or an authorized CRESTRON dealer. Purchasers should inquire of the dealer regarding the nature and extent of the dealer's warranty, if any.

CRESTRON shall not be liable to honor the terms of this warranty if the product has been used in any application other than that for which it was intended or if it has been subjected to misuse, accidental damage, modification or improper installation procedures. Furthermore, this warranty does not cover any product that has had the serial number altered, defaced or removed.

This warranty shall be the sole and exclusive remedy to the original purchaser. In no event shall CRESTRON be liable for incidental or consequential damages of any kind (property or economic damages inclusive) arising from the sale or use of this equipment. CRESTRON is not liable for any claim made by a third party or made by the purchaser for a third party.

CRESTRON shall, at its option, repair or replace any product found defective, without charge for parts or labor. Repaired or replaced equipment and parts supplied under this warranty shall be covered only by the unexpired portion of the warranty.

Except as expressly set forth in this warranty, CRESTRON makes no other warranties, expressed or implied, nor authorizes any other party to offer any warranty, including any implied warranties of merchantability or fitness for a particular purpose. Any implied warranties that may be imposed by law are limited to the terms of this limited warranty. This warranty statement supersedes all previous warranties.

Trademark Information

All brand names, product names and trademarks are the sole property of their respective owners. Windows is a registered trademark of Microsoft Corporation. Windows 95/98/Me/XP/Vista/7 and Windows NT/2000 are trademarks of Microsoft Corporation.



Crestron Electronics, Inc.
15 Volvo Drive Rockleigh, NJ 07647
Tel: 888.CRESTRON
Fax: 201.767.7576
www.crestron.com

Operations Guide – DOC. 6976A
(2027298)
07.10
Specifications subject to
change without notice.