



TEST REPORT

<p>KCTL Inc. 65, Sinwon-ro, Yeongtong-gu, Suwon-si, Gyeonggi-do, 16677, Korea TEL: 82-31-285-0894 FAX: 82-505-299-8311 www.kctl.co.kr</p>	<p>Report No.: KR17-SEV0048-A Page (1) of (27)</p>	
--	--	---

1. Client

- Name : Crestron Electronics Inc.
- Address : 15 Volvo Drive, Rockleigh, NJ 07647, United States
- Date of Receipt : 2017-09-28

2. Use of Report : -



3. Name of Product and Model : Dual-Channel Modular Power Amplifier, 25W/Ch.,
 4/8Ω / AMP-225

4. Manufacturer and Country of Origin : Crestron Electronics Inc. / USA

5. Date of Test : 2017-10-13

6. Test method used : VCCI-CISPR 32:2016, Class B

7. Test Results : Refer to the test result in the test report

<p>Affirmation</p>	<p>Tested by  Name : Donghyun Kim (Signature)</p>	<p>Technical Manager  Name : Gunsu Park (Signature)</p>
--------------------	--	--

2017-12-14

KCTL Inc.

As a test result of the sample which was submitted from the client, this report does not guarantee the whole product quality. This test report should not be used and copied without a written agreement by KCTL Inc.

REPORT REVISION HISTORY

Date	Revision	Page No
2017-10-19	Originally issued(KR17-SEV0048)	-
2017-12-14	Changed name of product(KR17-SEV0048-A)	-

This report shall not be reproduced except in full, without the written approval of KCTL Inc. This document may be altered or revised by KCTL Inc. personnel only, and shall be noted in the revision section of the document. Any alteration of this document not carried out by KCTL Inc. will constitute fraud and shall nullify the document.



Contents

1. Applicant information	4
2. Laboratory information	5
3. Test system configuration	6
3.1 Operation environment.....	6
3.2 Measurement Uncertainty	7
3.3 Measurement Program.....	8
4. Description of EUT	9
4.1 General information.....	9
4.2 Product description.....	10
4.3 Auxiliary equipments	10
4.4 Test configuration	11
4.5 Operating conditions	11
5. Summary of test results	12
5.1 Summary of EMI emission test results.....	12
6. Test results	13
6.1 Conducted Emission	13
6.2 Radiated Emission	17
7. EUT photographs	24

KCTL Inc.

65, Sinwon-ro, Yeongtong-gu,
Suwon-si, Gyeonggi-do, 16677, Korea
TEL: 82-31-285-0894 FAX: 82-505-299-8311
www.kctl.co.kr

Report No.:
KR17-SEV0048-A

Page (4) of (27)

KCTL

1. Applicant information

Applicant: Crestron Electronics Inc.
Address: 15 Volvo Drive, Rockleigh, NJ 07647, United States
Telephone: +01-800-237-2041
E-mail: cpatel@crestron.com
Contact name: Chirag Patel

Manufacturer: Crestron Electronics Inc.
Address: 15 Volvo Drive, Rockleigh, NJ 07647, United States
Telephone: +01-800-237-2041
E-mail: cpatel@crestron.com
Contact name: Chirag Patel

KCTL

KCTL Inc.

65, Sinwon-ro, Yeongtong-gu,
Suwon-si, Gyeonggi-do, 16677, Korea
TEL: 82-31-285-0894 FAX: 82-505-299-8311
www.kctl.co.kr

Report No.:
KR17-SEV0048-A

Page (5) of (27)

KCTL

2. Laboratory information

Address

KCTL Inc. (Suwon Lab.)

65, Sinwon-ro, Yeongtong-gu, Suwon-si, Gyeonggi-do, 16677, Korea

Telephone Number: 82 31 285 0894

Facsimile Number: 82 505 299 8311

FCC Site Designation No: KR0040, FCC Site Registration No: 687132

VCCI Registration No. : R-3327, G-198, C-3706, T-1849

Industry Canada Registration No. : 8035A

KOLAS NO.: KT231

SITE MAP



3. Test system configuration

3.1 Operation environment

	Temperature	Humidity	Pressure
Chamber 10 m(RE)	21.7 °C	49.5 % R.H.	-
Shielded room(CE)	24.1 °C	51.4 % R.H.	-

Test site

These testing items were performed following locations;

Test item	Test site
Conducted Emission	Shielded Room
Radiated Emission	10 m Chamber

3.2 Measurement Uncertainty

All measurements involve certain levels of uncertainties, especially in field of EMC.

The factors contributing to uncertainties are test receiver, cable loss, antenna factor calibration, Antenna directivity, antenna factor variation with height, antenna phase center variation, antenna frequency interpolation, measurement distance variation, site imperfection, mismatch, and system repeatability. Based on CISPR 16-4-2, the measurement uncertainty level with a 95 % confidence level was applied.

Conducted Emission measurement (Confidence level about 95 %, $k = 2$)			
Shielded Room (CE#1)	9 kHz ~ 150 kHz: 3.66 dB		
	150 kHz ~ 30 MHz: 3.26 dB		
Shielded Room (CE#2)	9 kHz ~ 150 kHz: 3.48 dB		
	150 kHz ~ 30 MHz: 3.06 dB		
Radiated Emission measurement (Confidence level about 95 %, $k = 2$)			
10 m Chamber (4F)	30 MHz ~ 300 MHz	3 m: 5.42 dB	
		10 m: 5.40 dB	
	300 MHz ~ 1 000 MHz	3 m: 5.56 dB	
		10 m: 5.44 dB	
	1 GHz ~ 6 GHz		3 m: 6.28 dB
	10 m Chamber (2F)	30 MHz ~ 300 MHz	3 m: 5.06 dB
10 m: 5.04 dB			
300 MHz ~ 1 000 MHz		3 m: 5.18 dB	
		10 m: 5.06 dB	
1 GHz ~ 6 GHz		3 m: 6.36 dB	
Radio Frequency Electromagnetic Fields (Confidence level about 95 %, $k = 2$)			
0.86 dB			
Disturbance Power Electromagnetic Fields (Confidence level about 95 %, $k = 2$)			
2.82 dB			

3.3 Measurement Program

These test items were performed by software programs;

Test item	Measurement Program		Used
Conducted Emission	EP5CE_V 5.4.0(TOYO)		☒
Radiated Emission	2F	EP5RE_V 4.6.0(TOYO)	☒
	4F	EP5RE_V 5.11.10(TOYO)	



KCTL Inc.

65, Sinwon-ro, Yeongtong-gu,
Suwon-si, Gyeonggi-do, 16677, Korea
TEL: 82-31-285-0894 FAX: 82-505-299-8311
www.kctl.co.kr

Report No.:
KR17-SEV0048-A

Page (9) of (27)

KCTL

4. Description of EUT

4.1 General information

Audio

Input Signal Types: Balanced or unbalanced analog line-level
Output Power: 25 Watts per channel @ 4-8 Ohms
Frequency Response: 20 Hz to 20 kHz ± 0.5 dB
THD+N: <0.1% at full rated output power
S/N Ratio: >100 dBA, 20 Hz to 20 kHz, balanced
Crosstalk: -75 dB at 1 kHz

Input Sensitivity: 1.23 Vrms, +4 dBu balanced;
0.316 Vrms, -10 dBV unbalanced;
For full rated output power

Go To Sleep Time: 25 minutes with no signal present

Wake Time: 0.5 second typical

Wake Threshold: 5 to 20 mV typical

Protection: Clip limiter, over current, under voltage, over temperature,
DC offset, extreme high frequency

Connectors

SPEAKER OUT 1 – 2: (2) 2-pin 7.62 mm reversed gender 20A detachable
terminal blocks; Power amplifier outputs;

Wire Size: Terminals accept up to 12 AWG (3.31 mm²)

AUDIO IN 1 – 2 (unbalanced): (2) RCA connectors, female;

Unbalanced line-level audio inputs;

Maximum Input Level: 2.24 Vrms, +7 dBV (+9.2 dBu)

AUDIO IN 1 – 2 (balanced): (1) 5-pin 3.5 mm detachable terminal block;

Balanced line-level audio inputs;

Maximum Input Level: 7.75 Vrms, +20 dBu;

Input Impedance: 20k Ohms

G: (1) 6-32 screw;

Chassis ground lug

100-240V~1A 50/60 Hz: (1) IEC 60320 C14 main power inlet;

Mates with removable power cord, included

Controls & Indicators

PWR: (1) Bi-color green/amber LED, indicates operating power supplied
from AC line power, turns green while operating and amber when
in standby

Power

Main Power: 1 Amp @ 100-240 Volts AC, 50/60 Hz

Power Consumption: 17 Watts, all channels driven at 1/8th output power;
8 Watts, idle;
<0.5 Watt, standby (sleep)

Environmental

Temperature: 41° to 104° F (5° to 40° C)

Humidity: 10% to 90% RH (non-condensing)

Construction

Chassis: Metal, convection-cooled (fanless), vented front and rear

Front Panel: Metal, black finish with polycarbonate label overlay

Mounting: Freestanding, surface-mount, or 1/4-width 1 RU 19-inch rack-
mountable; gangable with other Crestron modular AMP series products
(adhesive feet, surface mounting kit, ganging kit, and rack mounting
kit included)

Dimensions

Height: 1.74 in (45 cm) without feet;

1.82 in (47 mm) with surface kit

Width: 4.33 in (110 mm);

5.43 in (138 mm) with surface kit;

19.00 in (483 mm) with rack kit

Depth: 10.46 in (266 mm)

Weight

1.9 lb (0.9 kg) without mounting kits

2.2 lb (1.0 kg) maximum with surface or rack kit

Compliance

ENERGY STAR, ErP (1275/2008/EC), UL 60065, FCC Class A
commercial use

4.2 Product description

Type of product	Dual-Channel Modular Power Amplifier, 25W/Ch., 4/8Ω
Model name (Basic)	AMP-225
Model name (Variant)	-
Difference	-
Serial no	-
Testing voltage	100 V, 50 Hz
Input rating	100 V - 240 V, 50/60 Hz
Internal clock frequency	500 MHz
Note	-

4.3 Auxiliary equipments

Type	Model / Part #	S/N	Manufacturer
Mobile Phone #1	GT-N7105	-	SAMSUNG
Mobile Phone #2	LG-F200L	-	LG
Speaker #1	-	-	Crestron Electronics Inc.
Speaker #2	-	-	Crestron Electronics Inc.

4.4 Test configuration

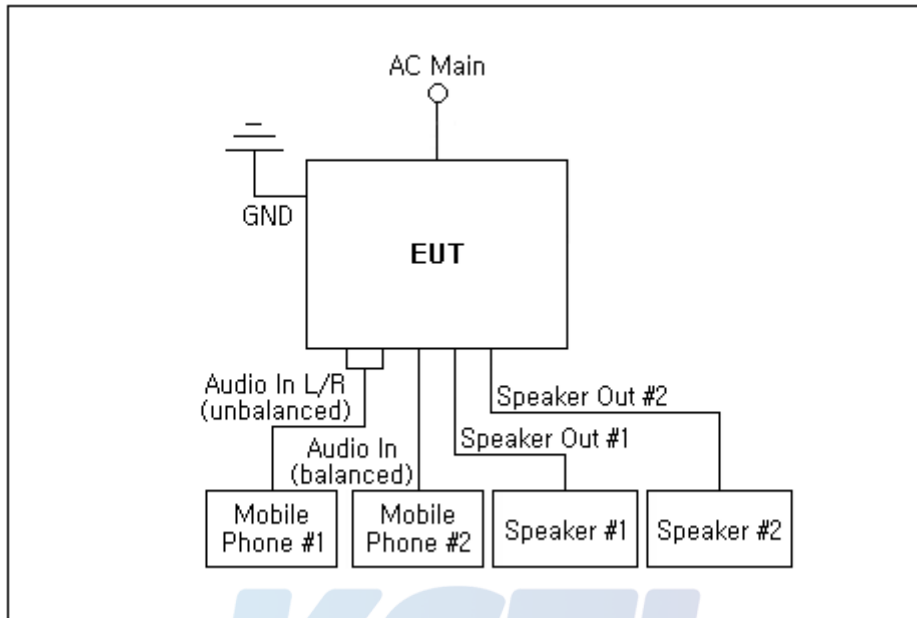

	Start		End		Cable	
	Name	I/O port	Name	I/O port	Length (m)	Spec.
1	EUT	Power	AC Main	-	2.0	Unshield
2		Audio In L/R (unbalanced)	Mobile Phone #1	AUX	3.0	Unshield
3		Audio In (balanced)	Mobile Phone #2	AUX	3.0	Unshield
4		Speaker Out #1	Speaker #1	Speaker In	3.0	Unshield
5		Speaker Out #2	Speaker #2	Speaker In	3.0	Unshield
6		GND	GND	-	2.0	-

4.5 Operating conditions

The EUT was configured as normal intended use.

Test mode	Normal operating
Test #1	After arranging as above, mobile phones #1 and #2 are used to check the output state of the speaker after 1 kHz music playback and test.

5. Summary of test results

5.1 Summary of EMI emission test results

Applied	Test items	Test method	Result
<input checked="" type="checkbox"/>	Conducted Emission	VCCI-CISPR 32:2016, Class B	Pass
<input checked="" type="checkbox"/>	Radiated Emission	VCCI-CISPR 32:2016, Class B	Pass



6. Test results

6.1 Conducted Emission

Test specification	VCCI-CISPR 32:2016, Class B		
Testing voltage	100 V, 50 Hz		
Test facility	Shielded room (CE#2)		
Date	2017-10-13		
Temperature (°C)	24.1 °C	Humidity (% R.H.)	51.4 % R.H.
Remarks	Pass		

Both conducted lines are measured in Quasi-Peak and C/Average mode, including the worst-case data points for each tested configuration. The EUT measured in accordance with the methods described in standards.

6.1.1 Limits of conducted emission measurement

AC main

Frequency [MHz]	Resolution Bandwidth [kHz]	Class A (dB(μ V))		Class B (dB(μ V))	
		Quasi-peak	Average	Quasi-peak	Average
0.15 ~ 0.5	9	79	66	66 ~ 56	56 ~ 46
0.5 ~ 5	9	73	60	56	46
5 ~ 30	9	73	60	60	50

Wired network

Frequency [MHz]	Resolution Bandwidth [kHz]	Class A Limits (dB(μ V))		Current Limits (dB(μ V))	
		Quasi-Peak	Average	Quasi-Peak	Average
0.15 ~ 0.5	9	97 to 87	84 to 74	53 to 43	40 to 30
0.5 ~ 30	9	87	74	43	30
Frequency [MHz]	Resolution Bandwidth [kHz]	Class B Limits (dB(μ V))		Current Limits (dB(μ V))	
		Quasi-Peak	Average	Quasi-Peak	Average
0.15 ~ 0.5	9	84 to 74	74 to 64	40 to 30	30 to 20
0.5 ~ 30	9	74	64	30	20

If the reading on the measuring receiver shows fluctuations close to the limit, the reading shall be observed for at least 15 seconds at each measurement frequency, the highest reading shall be recorded, with the exception of any brief isolated high reading (which shall be ignored).

6.1.2 Used equipments

Equipment	Model no.	Serial no.	Makers	Next Cal. Date	Used
EMI TEST RECEIVER	ESCI	100710	R&S	2018.08.24	<input checked="" type="checkbox"/>
TWO-LINE V-NETWORK	ENV216	101352	R&S	2018.08.25	<input checked="" type="checkbox"/>
TWO-LINE V-NETWORK	NNLK8121	8121-472	SCHWARZBECK	2018.08.25	<input type="checkbox"/>



KCTL Inc.

65, Sinwon-ro, Yeongtong-gu,
Suwon-si, Gyeonggi-do, 16677, Korea
TEL: 82-31-285-0894 FAX: 82-505-299-8311
www.kctl.co.kr

Report No.:
KR17-SEV0048-A
Page (15) of (27)



6.1.3 Photographs of test setup

AC Main

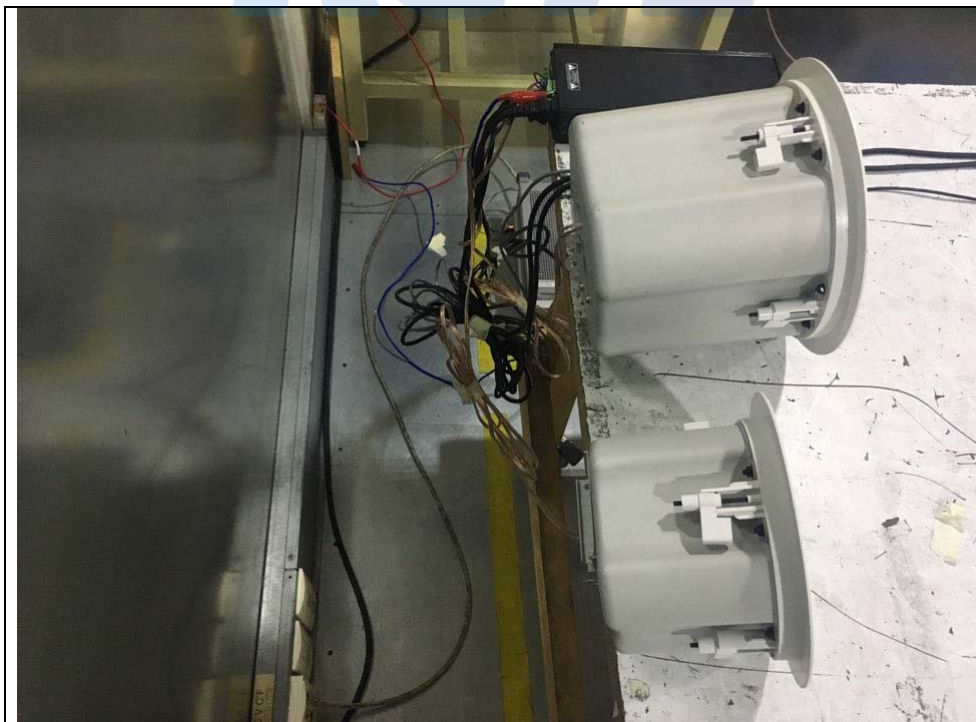
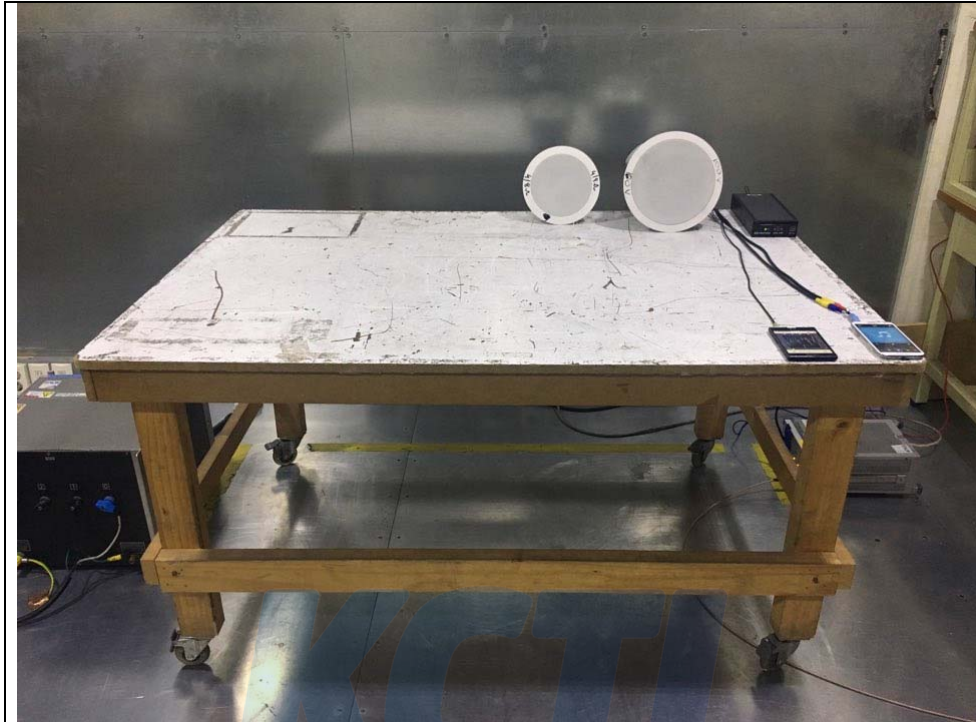

KCTL Inc.

65, Sinwon-ro, Yeongtong-gu,
Suwon-si, Gyeonggi-do, 16677, Korea
TEL: 82-31-285-0894 FAX: 82-505-299-8311
www.kctl.co.kr

Report No.:
KR17-SEV0048-A
Page (16) of (27)



6.1.4 Conducted emission measurement result

AC Main

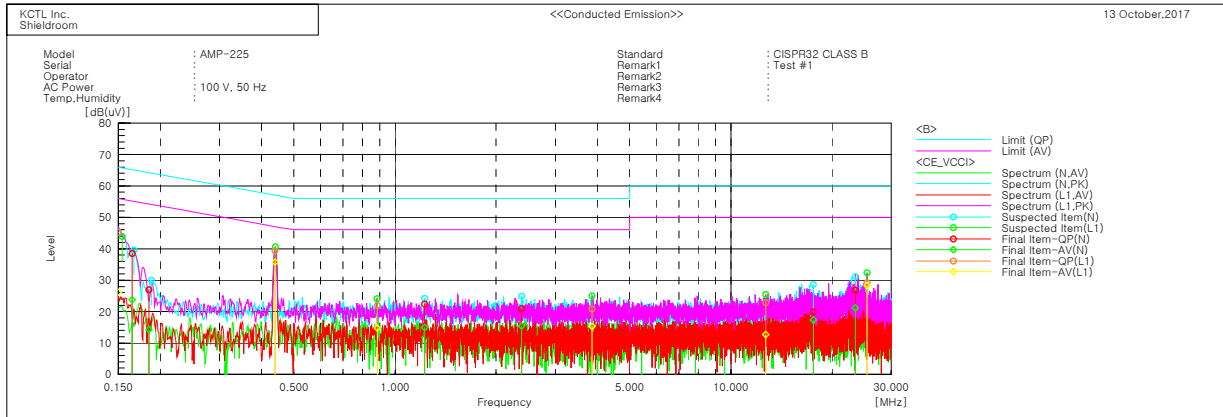

Final Result

--- N Phase ---										
No.	Frequency [MHz]	Reading QP [dB(uV)]	Reading CAV [dB(uV)]	c. f [dB]	Result QP [dB(uV)]	Result CAV [dB(uV)]	Limit QP [dB(uV)]	Limit AV [dB(uV)]	Margin QP [dB]	Margin CAV [dB]
1	0.16505	28.2	13.5	10.3	38.5	23.8	65.2	55.2	26.7	31.4
2	0.18497	16.7	4.0	10.3	27.0	14.3	64.3	54.3	37.3	40.0
3	1.22377	12.3	4.8	10.1	22.4	14.9	56.0	46.0	33.6	31.1
4	2.38313	10.8	5.3	10.1	20.9	15.4	56.0	46.0	35.1	30.6
5	17.60222	9.7	7.0	10.3	20.0	17.3	60.0	50.0	40.0	32.7
6	23.48206	16.5	10.8	10.3	26.8	21.1	60.0	50.0	33.2	28.9

--- L1 Phase ---										
No.	Frequency [MHz]	Reading QP [dB(uV)]	Reading CAV [dB(uV)]	c. f [dB]	Result QP [dB(uV)]	Result CAV [dB(uV)]	Limit QP [dB(uV)]	Limit AV [dB(uV)]	Margin QP [dB]	Margin CAV [dB]
1	0.15003	35.3	16.1	10.0	45.3	26.1	66.0	56.0	20.7	29.9
2	0.43867	29.3	25.7	10.1	39.4	35.8	57.1	47.1	17.7	11.3
3	0.88501	11.9	4.6	10.1	22.0	14.7	56.0	46.0	34.0	31.3
4	3.85847	10.7	5.2	10.1	20.8	15.3	56.0	46.0	35.2	30.7
5	12.7048	12.7	2.5	10.2	22.9	12.7	60.0	50.0	37.1	37.3
6	25.42271	18.9	17.9	10.3	29.2	28.2	60.0	50.0	30.8	21.8

6.2 Radiated Emission

Test specification	VCCI-CISPR 32:2016, Class B		
Testing voltage	100 V, 50 Hz		
Test facility	10 m Chamber (4F)		
Test distance	10 m, 3 m		
Date	2017-10-13		
Temperature (°C)	21.7 °C	Humidity (% R.H.)	49.5 % R.H.
Remarks	Pass		

Of those emissions above ($L - 20$ dB), where L is the limit level in logarithmic units, record at least the emission levels and the frequencies of the six highest emissions.

The following data lists the significant emission frequencies, measured levels, correction factors (for antenna and cables), orientation of table, polarization and height of antenna, the corrected reading, the limit, and the amount of margin. All measurements were taken utilizing quasi-peak detection unless stated otherwise.

Measurements were performed at an antenna to EUT distance of 10 or 3 meters and elevated between 1 and 4 meters. Both vertical and horizontal antenna polarizations were measured.

Below 1 GHz, peak detector function mode for prescan was used with resolution bandwidth of 120 kHz and a video bandwidth of 300 kHz and sweep method.

The sweep time for prescan set below 200 ms up and final measurement with quasi-peak detector evaluated for suspected frequencies points, which are detected from prescan measurement.

Final measurements consisted of 3 steps.

First step, frequency fine tuning to find exact emission frequency.

Second step, rechecking to search for maximum height and azimuth for interference from EUT

In final step, there are conducted measuring with quasi-peak detector for points

which are detected from 1st step & 2nd step.

6.2.1 Limits of radiated emission measurement

Limits below 1 GHz

Frequency [MHz]	Resolution Bandwidth [kHz]	Class A (dB(μ V/m)) @ 10 m	Class B (dB(μ V/m)) @ 10 m
30 ~ 230	120	40	30
230 ~ 1 000	120	47	37

Limits above 1 GHz

Frequency [GHz]	Resolution Bandwidth [MHz]	Class A @ 3 m		Class B @ 3 m	
		Average limit (dB(μ V/m))	Peak limit (dB(μ V/m))	Average limit (dB(μ V/m))	Peak limit (dB(μ V/m))
1 ~ 3	1	56	76	50	70
3 ~ 6	1	60	80	54	74

Note - The lower limit applies at the transition frequency.

Measurements within 20 dB of the limit were then maximized by adjusting turntable position.

Final measurements were made using an C/Average detector.

Results checked manually and points close to the limit line were re-measured.

6.2.2 Used equipments

Equipment	Model no.	Serial no.	Makers	Next Cal. Date	Used
EMI TEST RECEIVER	ESR7	101078	R&S	2018.08.24	<input checked="" type="checkbox"/>
Bilog Antenna	VULB9168	583	SCHWARZBECK	2018.06.10	<input checked="" type="checkbox"/>
AMPLIFIER	310N	293004	SONOMA	2018.08.24	<input checked="" type="checkbox"/>
COAXIAL FIXED ATTENUATOR	8491B-003	2708A18758	AGILENT	-	<input checked="" type="checkbox"/>
Antenna Mast	MA4640-XP-ET	-	Innco Systems	-	<input checked="" type="checkbox"/>
Turn Table	TT 3.0-3t	-	MATURO	-	<input checked="" type="checkbox"/>
PREAMPLIFIER	8449B	3008A01802	AGILENT	2018.04.06	<input checked="" type="checkbox"/>
DOUBLE RIDGED HORN ANTENNA	3115	00086706	ETS-LINDGREN	2018.09.09	<input checked="" type="checkbox"/>
Spectrum Analyzer	FSV40	100988	R&S	2018.01.06	<input type="checkbox"/>

KCTL Inc.

65, Sinwon-ro, Yeongtong-gu,
Suwon-si, Gyeonggi-do, 16677, Korea
TEL: 82-31-285-0894 FAX: 82-505-299-8311
www.kctl.co.kr

Report No.:
KR17-SEV0048-A

Page (19) of (27)



6.2.3 Sample calculation

The field strength is calculated adding the antenna Factor, cable loss and, Antenna pad adding, subtracting the amplifier gain from the measured reading.

The sample calculation is as follow:

$$\text{Result} = \text{M.R} + \text{C.F}(\text{A.F} + \text{C.L} + 6 \text{ dB Att} - \text{A.G})$$

M.R = Meter Reading

C.F = Correction Factor

A.F = Antenna Factor

C.L = Cable Loss

A.G = Amplifier Gain

6 dB Att = 6 dB Attenuator

If M.R is 30 dB, A.F 12 dB, C.L 5 dB, 6 dB, A.G 35 dB

The result is $30 + 12 + 5 + 6 - 35 = 18 \text{ dB}(\mu\text{V}/\text{m})$

Bilog Antenna and ATTENUATOR (6 dB) were calibrated together.

AV = CAV : Abbreviation of CISPR Average

Correction

$$E_m = E_{dm} + 20\log(d/3)$$

E_m : Result, E_{dm} : Measured value of the measured distance

6.2.4 Photographs of test setup

30 MHz ~ 1 GHz



KCTL Inc.

65, Sinwon-ro, Yeongtong-gu,
Suwon-si, Gyeonggi-do, 16677, Korea
TEL: 82-31-285-0894 FAX: 82-505-299-8311
www.kctl.co.kr

Report No.:
KR17-SEV0048-A

Page (21) of (27)

KCTL

1 GHz ~ 6 GHz



KCTL Inc.

65, Sinwon-ro, Yeongtong-gu,
Suwon-si, Gyeonggi-do, 16677, Korea
TEL: 82-31-285-0894 FAX: 82-505-299-8311
www.kctl.co.kr

Report No.:
KR17-SEV0048-A

Page (22) of (27)



6.2.5 Radiated emission measurement result

30 MHz ~ 1 GHz

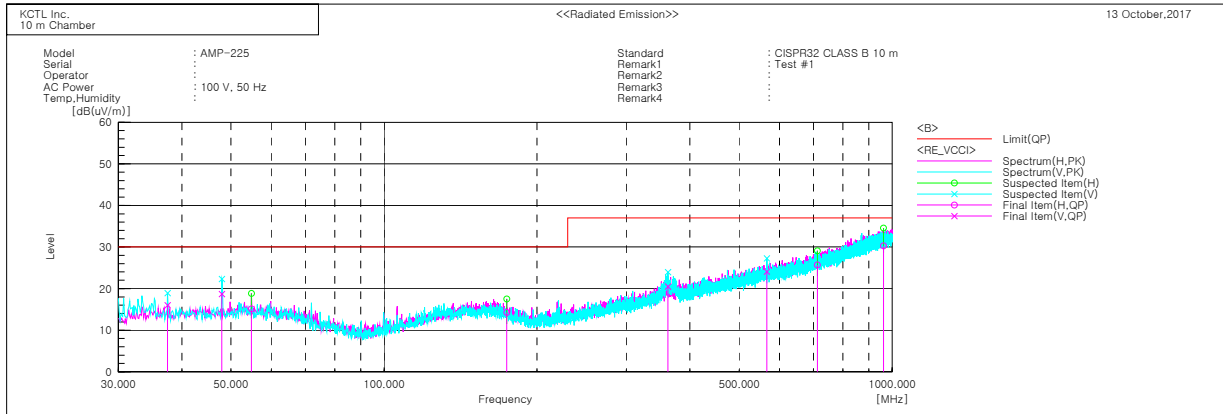

Final Result

No.	Frequency [MHz]	(P)	Reading QP [dB(uV)]	c.f [dB(1/m)]	Result QP [dB(uV/m)]	Limit QP [dB(uV/m)]	Margin QP [dB]	Height [cm]	Angle [deg]
1	37.518	V	28.1	-12.1	16.0	30.0	14.0	127.0	226.7
2	47.945	V	29.8	-11.1	18.7	30.0	11.3	279.0	357.1
3	54.856	H	26.1	-11.0	15.1	30.0	14.9	237.0	77.8
4	174.409	H	24.9	-10.6	14.3	30.0	15.7	318.0	36.2
5	362.104	V	26.8	-6.3	20.5	37.0	16.5	176.0	60.8
6	567.016	V	24.5	-0.4	24.1	37.0	12.9	386.0	278.7
7	712.638	H	23.5	2.2	25.7	37.0	11.3	149.0	324.7
8	961.443	H	22.3	8.0	30.3	37.0	6.7	287.0	323.6

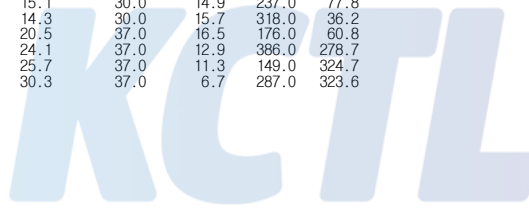

KCTL Inc.

65, Sinwon-ro, Yeongtong-gu,
Suwon-si, Gyeonggi-do, 16677, Korea
TEL: 82-31-285-0894 FAX: 82-505-299-8311
www.kctl.co.kr

Report No.:
KR17-SEV0048-A

Page (23) of (27)



1 GHz ~ 6 GHz

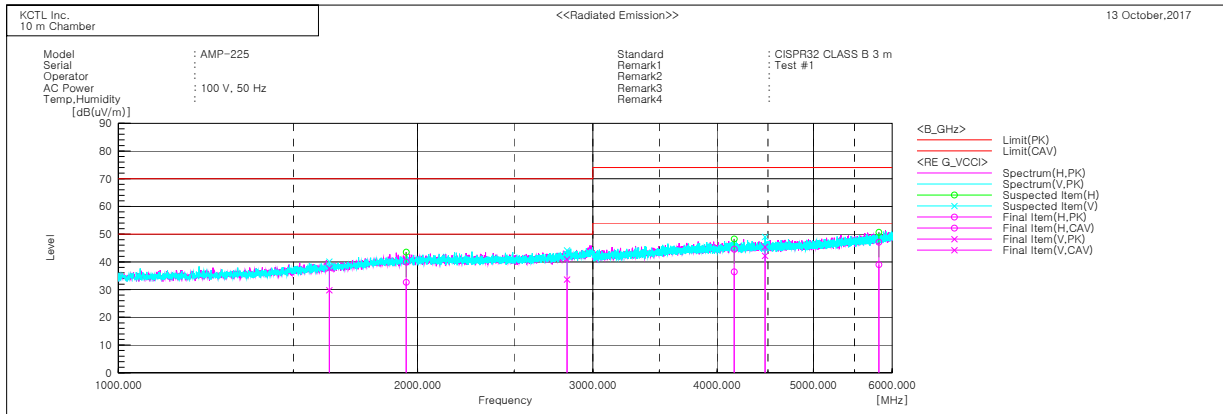

Final Result

No.	Frequency [MHz]	(P)	Reading PK [dB(μV)]	Reading CAV [dB(μV)]	c.f [dB(1/m)]	Result PK [dB(μV/m)]	Result CAV [dB(μV/m)]	Limit PK [dB(μV/m)]	Limit AV [dB(μV/m)]	Margin PK [dB]	Margin CAV [dB]	Height [cm]	Angle [deg]
1	1629.960	V	44.3	36.4	-6.6	37.7	29.8	70.0	50.0	32.3	20.2	100.0	348.4
2	1947.992	H	43.6	36.3	-3.7	39.9	32.6	70.0	50.0	30.1	17.4	100.0	307.4
3	2826.395	V	43.2	35.9	-2.3	40.9	33.6	70.0	50.0	29.1	16.4	100.0	58.9
4	4163.228	H	40.8	32.6	3.8	44.6	36.4	74.0	54.0	29.4	17.6	100.0	106.9
5	4470.883	V	41.4	38.2	4.0	45.4	42.2	74.0	54.0	28.6	11.8	100.0	102.1
6	5820.535	H	39.4	31.3	7.7	47.1	39.0	74.0	54.0	26.9	15.0	100.0	148.0



◆ Correction(Distance: 3.5 m)

Frequency [MHz]	(P)	Reading PK [dB(μV)]	Reading CAV [dB(μV)]	c.f [dB(1/m)]	Result PK [dB(μV/m)]	Result CAV [dB(μV/m)]	Limit PK [dB(μV/m)]	Limit AV [dB(μV/m)]	Margin PK [dB]	Margin CAV [dB]
1629.960	V	44.3	36.4	-5.3	39.0	31.1	70.0	50.0	31.0	18.9
1947.992	H	43.6	36.3	-2.4	41.2	33.9	70.0	50.0	28.8	16.1
2826.395	V	43.2	35.9	-1.0	42.2	34.9	70.0	50.0	27.8	15.1
4163.228	H	40.8	32.6	5.1	45.9	37.7	74.0	54.0	28.1	16.3
4470.883	V	41.4	38.2	5.3	46.7	43.5	74.0	54.0	27.3	10.5
5820.535	H	39.4	31.3	9.0	48.4	40.3	74.0	54.0	25.6	13.7

This test report shall not be reproduced, except in full, without the written approval.

KCTL Inc.

65, Sinwon-ro, Yeongtong-gu,
Suwon-si, Gyeonggi-do, 16677, Korea
TEL: 82-31-285-0894 FAX: 82-505-299-8311
www.kctl.co.kr

Report No.:
KR17-SEV0048-A
Page (24) of (27)



7. EUT photographs

Front View



Rear View



KCTL Inc.

65, Sinwon-ro, Yeongtong-gu,
Suwon-si, Gyeonggi-do, 16677, Korea
TEL: 82-31-285-0894 FAX: 82-505-299-8311
www.kctl.co.kr

Report No.:
KR17-SEV0048-A
Page (25) of (27)

KCTL

Left View



Right View



KCTL Inc.

65, Sinwon-ro, Yeongtong-gu,
Suwon-si, Gyeonggi-do, 16677, Korea
TEL: 82-31-285-0894 FAX: 82-505-299-8311
www.kctl.co.kr

Report No.:
KR17-SEV0048-A
Page (26) of (27)

KCTL

Top View



Bottom View



KCTL Inc.

65, Sinwon-ro, Yeongtong-gu,
Suwon-si, Gyeonggi-do, 16677, Korea
TEL: 82-31-285-0894 FAX: 82-505-299-8311
www.kctl.co.kr

Report No.:
KR17-SEV0048-A

Page (27) of (27)

KCTL

Inside

