



View this document in HTML
crestron.com/docs/9370



Product Manual

DM-NAX-XSP

DM NAX® 8K Smart Display Controller
and Network Audio Encoder/Decoder
with eARC Support

Original Instructions

The U.S. English version of this document is the original instructions.
All other languages are a translation of the original instructions.

Regulatory Model: M202116001

Crestron product development software is licensed to Crestron dealers and Crestron Service Providers (CSPs) under a limited nonexclusive, nontransferable Software Development Tools License Agreement. Crestron product operating system software is licensed to Crestron dealers, CSPs, and end-users under a separate End-User License Agreement. Both of these Agreements can be found on the Crestron website at www.crestron.com/legal/software_license_agreement.

The product warranty can be found at www.crestron.com/warranty.

The specific patents that cover Crestron products are listed at www.crestron.com/legal/patents.

Certain Crestron products contain open source software. For specific information, visit www.crestron.com/opensource.

This product is manufactured under license from Dolby Laboratories and license from DTS, Inc. and/or DTS Licensing Limited.

For DTS patents, see <http://patents.dts.com>.

Crestron, Crestron Home, Crestron Toolbox, the Crestron logo, DM NAX, and DM NVX are either trademarks or registered trademarks of Crestron Electronics, Inc. in the United States and/or other countries. Dante is either a trademark or registered trademark of Audinate Pty Ltd. in the United States and/or other countries. Dolby, Dolby Atmos, Dolby Digital, Dolby Vision, and the double-D symbol are either trademarks or registered trademarks of Dolby Laboratories Licensing Corporation in the United States and/or other countries. DTS, DTS HD, DTS:X, and the DTS:X logo are either trademarks or registered trademarks of DTS, Inc. in the United States and/or other countries. HDMI, the HDMI logo, and High Definition Multimedia Interface are either trademarks or registered trademarks of HDMI Licensing LLC in the United States and/or other countries. Intertek is either a trademark or registered trademark of Intertek Group in the United States and/or other countries. Other trademarks, registered trademarks, and trade names may be used in this document to refer to either the entities claiming the marks and names or their products. Crestron disclaims any proprietary interest in the marks and names of others. Crestron is not responsible for errors in typography or photography.

HDMI**Dolby Atmos****dts x**

©2024 Crestron Electronics, Inc.

Contents

- Overview** 1
- Specifications** 3
 - Product Specifications 3
 - Dimension Drawings 5
- Application Diagrams** 6
 - Downmixing eARC Audio to Other DM NAX® Devices 6
 - Preserving Surround Sound to Other DM-NAX-XSP Devices 7
- Installation** 9
 - In the Box 10
 - Install the Device 11
 - Connect the Mounting Brackets 11
 - Mount to a Wall 13
 - Mount under a Table 14
 - Install on a Rack Rail 15
 - Connect the Device 16
 - Observe the LED Indicators 17
 - Reset the Device 18
 - Network Reset 18
 - Factory Restore 18
- Configuration** 19
 - Web Interface Configuration 19
 - Access the Web Interface 19
 - Action 22
 - Save Changes 23
 - Revert 23
 - Reboot the DM-NAX-XSP 23
 - Restore to Factory Default Settings 23
 - Update Firmware 24
 - Download Logs 24
 - Manage Certificates 25
 - Manage EDIDs 27
 - Manage Device Drivers 30
 - Download Configuration 32
 - Upload Configuration 32
 - Manage Schedule 34
 - Status 36
 - Device 36
 - Network 37

| | |
|---|-----------|
| Audio | 38 |
| Input/Output | 38 |
| Occupancy Sensor | 39 |
| Control System | 39 |
| Settings | 40 |
| System Setup | 40 |
| Occupancy Sensor | 45 |
| Port Selection | 46 |
| Input / Output Selection | 47 |
| DM NAX Streams | 54 |
| Security | 58 |
| Current User | 59 |
| Users | 60 |
| Groups | 64 |
| 802.1x Configuration | 67 |
| To Configure DM-NAX-XSP for 802.1X Authentication | 68 |
| Access the Web Interface With the Crestron Toolbox™ Application | 69 |
| Resources | 70 |
| Crestron Support and Training | 70 |
| Programmer and Developer Resources | 70 |
| Product Certificates | 70 |

Overview

The [DM-NAX-XSP](#) is an 8K display controller with a local HDMI input and HDMI passthrough, DM NAX AoIP encoder and decoder functionality, and eARC support. Its compact form factor facilitates mounting the device behind a display, or it can be mounted to a single rack rail using included hardware.

DM NAX[®] audio-over-IP is built on the AES67 standards, with additional ease of configuration via a web interface, SIMPL Windows, C#, and/or a RESTful API. It is compatible with DM NVX[®] AV-over-IP through the AES67 secondary audio stream, and also with third-party AES67 solutions and Dante[®] Networking via the compatibility mode enabled through Dante Controller.



- Audio-over-IP (AoIP) display controller and audio encoder/decoder
- Handles video resolutions up to 8K60 4:2:0 and 4K120 4:4:4
- Supports HDR10, HDR10+, and Dolby Vision[®] video formats
- Supports all Dolby[®] audio formats up to Dolby Atmos[®] and all DTS[®] formats up to DTS:X[®]
- eARC support available on HDMI[®] connection to display
- HDCP 2.3 compliant
- Connected device control via CEC, RS-232, IR, and relays
- Connects directly to a managed network to route audio to or from other DM NAX[®] and DM NVX[®] devices
- Interoperable with Dante[®] audio networking devices via AES67 compatibility
- Streamlined configuration through a web interface
- Seamless Crestron system integration with SIMPL Windows programming
- Compact, surface-mountable design
- PoE+ powered device

8K60 4:2:0, 4K120 4:4:4, and HDR Support

The DM-NAX-XSP supports video resolutions up to 8K60 with 4:2:0 color sampling, 8K30 4:4:4, or 4K120 4:4:4. HDR10, HDR10+, and Dolby Vision video formats are also supported.

eARC Support

The HDMI output of the DM-NAX-XSP supports Enhanced Audio Return Channel (eARC) connectivity, allowing audio to be extracted from a connected display and transmitted over the network as a DM NAX AoIP stream. Extracting audio from the display via the eARC connection means only a single cable is required for video and bidirectional audio. This connection also allows local audio content from the display (such as smart TV streaming applications) to be encoded as streams available to an AoIP audio distribution system.

Surround Sound and Downmixing

The HDMI input and eARC connections of the DM-NAX-XSP support Dolby audio formats including Dolby Atmos and DTS formats including DTS:X. Digital audio formats received at the HDMI input can be passed through to the HDMI output. Supported surround sound formats can be downmixed to stereo via the built-in DSP to transmit a 2-channel AoIP stream onto the network.

Device Control via RS-232, IR, Relay, and Digital Input Ports

The DM-NAX-XSP includes built-in COM (RS-232), IR, relay, and digital input ports for controlling source devices and accessories.

CEC Control

CEC (Consumer Electronics Control) can control compatible source and display devices via the HDMI connection, eliminating the need for dedicated serial cables or IR emitters. CEC over the HDMI output can also turn the connected display on or off without additional programming.

Audio-over-IP

DM NAX takes audio distribution to a whole new level by putting it on the network. The DM-NAX-XSP sends and receives DM NAX and AES67 encoded audio over a standard IP network. A single DM NAX system can handle audio distribution between 32 DM NAX devices and supports up to 256 audio output zones. DM NAX devices can seamlessly pull and distribute the audio from DM NVX sources.

Specifications

Product specifications for the DM-NAX-XSP are provided below.

Product Specifications

Audio

| | |
|----------------------------|---|
| Input Signal Types | HDMI®, DM NAX audio-over-IP, AES67 |
| Output Signal Types | HDMI (multichannel pass-through), DM NAX audio-over-IP (2-channel downmix), AES67 (2-channel downmix) |
| Digital Formats | Dolby Digital®, Dolby Digital® EX, Dolby Digital Plus, Dolby TrueHD, Dolby Atmos®, DTS®, DTS ES, DTS 96/24, DTS HD® High Res, DTS HD Master Audio, DTS:X® |

Video

| | |
|----------------------------|--|
| Input Signal Types | HDMI with HDR10, HDR10+, Dolby Vision, Deep Color, 8K30 4:4:4 12-bit, and 4K120 4:4:4 12-bit support |
| Output Signal Types | HDMI with HDR10, HDR10+, Dolby Vision, Deep Color, 8K30 4:4:4 12-bit, and 4K120 4:4:4 12-bit support |
| Copy Protection | HDCP 2.3 |

Connectors

| | |
|-------------------|--|
| Ethernet 1 | (1) 8-pin RJ-45 connector, female; 100BASE-TX/1000BASE-T Ethernet port; PoE+ PD (powered device) port, IEEE 802.3at Type 2 PoE+ Class 4 (25.5 W) compliant |
| Ethernet 2 | (1) 8-pin RJ-45 connector, female; 100BASE-TX/1000BASE-T Ethernet port |
| HDMI IN | (1) HDMI Type A connector, female; HDMI digital video/audio input |
| HDMI OUT | (1) HDMI Type A connector, female; HDMI digital video/audio output, pass-through from HDMI IN ; eARC audio return support |
| COM | (1) 3-pin 3.5 mm detachable terminal block; Bidirectional RS-232 port; Up to 115.2k baud, hardware and software handshaking support |
| IR | (1) 2-pin 3.5 mm detachable terminal block; IR output up to 1.1 MHz; 1-way serial TTL (0-5 V) up to 19200 baud |
| RELAY | (1) 4-pin 3.5 mm detachable terminal blocks; Comprises (2) normally open, isolated relays; Rated 1A, 30VAC/VDC; MOV arc suppression across contacts |
| G | (1) 6-32 screw; Chassis ground lug |

| | |
|-----------|---|
| IN | (1) 2-pin 3.5 mm detachable terminal block; Programmable digital input; Input Voltage Range: 0-24VDC, referenced to GND; Logic Threshold: 2.5VDC nominal with 1V hysteresis band; Pull-up Resistor: 2.2k Ω |
|-----------|---|

Communications

| | |
|-----------------|--|
| Ethernet | For control, and/or console, 100/1000 Mbps, auto-switching, auto-negotiating, auto-discovery, full/half duplex, DHCP |
| RS-232 | 2-way device control and monitoring up to 115.2k baud with hardware and software handshaking via control system |
| IR | 1-way device control via infrared up to 1.1 MHz or serial TTL (0-5V) up to 19.2k baud via control system |
| HDMI | HDCP 2.3, EDID, CEC |

Controls and Indicators

| | |
|-------------------|---|
| PWR | (1) Green/amber bicolor LED; Amber indicates unit is powering up/loading firmware; Green indicates unit is fully powered and ready for use |
| HDMI IN | (1) Green LED, indicates sync detection at the HDMI input |
| HDMI OUT | (1) Green LED, indicates video signal transmission at the HDMI output |
| Ethernet 1 | Left amber LED indicates 1000 Mb link status; Left green LED indicates 100 Mb link status; Flashing right amber LED indicates Ethernet activity |
| Ethernet 2 | Left amber LED indicates 1000 Mb link status; Left green LED indicates 100 Mb link status; Flashing right amber LED indicates Ethernet activity |
| RESET | (1) Push button: Used for factory reset procedures; (1) LED, illuminates red when the button is pressed, flashes red when reset has been initiated |

Power

| | |
|--------------------------|---|
| PoE+ | IEEE 802.3at Type 2 Class 4 (25.5 W) compliant; Compatible with Crestron DM-PSU-ULTRA-MIDSPAN, PoE+ compliant Ethernet switch, or third-party IEEE 802.3at compliant PSE |
| Power Consumption | 14 W maximum |

Environmental

| | |
|--------------------|--------------------------------|
| Temperature | 32° to 104° F (0° to 40° C) |
| Humidity | 10% to 90% RH (non-condensing) |

Construction

| | |
|-----------------|---|
| Chassis | Metal, black finish, vented sides |
| Mounting | Surface-mountable or attachable to a single rack rail |

Dimensions

| | |
|--------|-------------------|
| Height | 5.03 in. (128 mm) |
| Width | 8.36 in. (213 mm) |
| Depth | 1.12 in. (29 mm) |

Weight

1.82 lb (0.83 kg)

Compliance

Regulatory Model: M202116001

Intertek® Listed for US & Canada, CE, IC, FCC Part 15 Class B digital device

To search for product certificates, refer to support.crestron.com/app/certificates.

Dimension Drawings

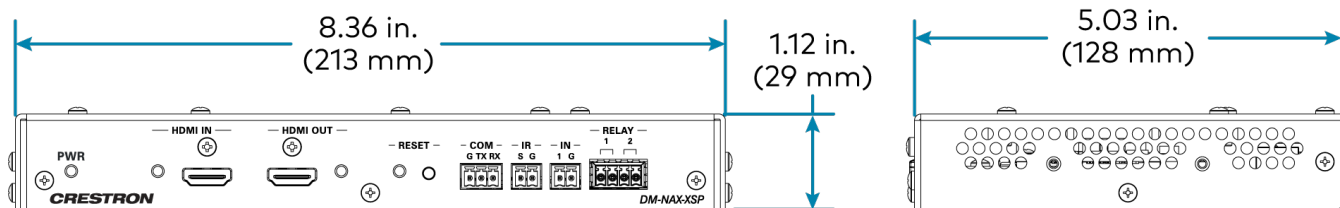
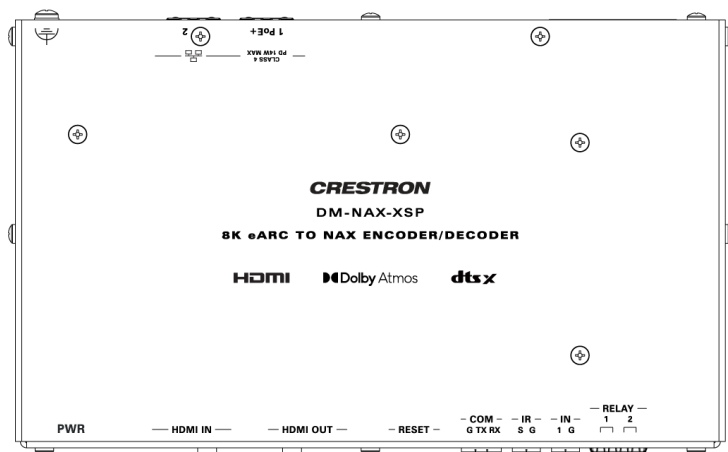

Application Diagrams

The following application diagrams cover examples of projects utilizing the DM-NAX-XSP eARC and Audio-over-IP capabilities.

Downmixing eARC Audio to Other DM NAX® Devices

In this scenario, the DM-NAX-XSP extracts surround sound audio from the display via eARC, downmixes it using the built-in DSP, and distributes a 2-channel stream to any number of zones on a DM NAX amplifier.

- The DM NVX® decoder at the display can receive either video source.
- The built-in streaming apps on the display can access cloud-based video content.
- Audio from either type of content (DM NVX A/V-over-IP or cloud-based) is received by the DM-NAX-XSP for extraction onto the Audio-over-IP network.

This setup is ideal for multi-room distribution of audio from cloud-based streaming services on the display.

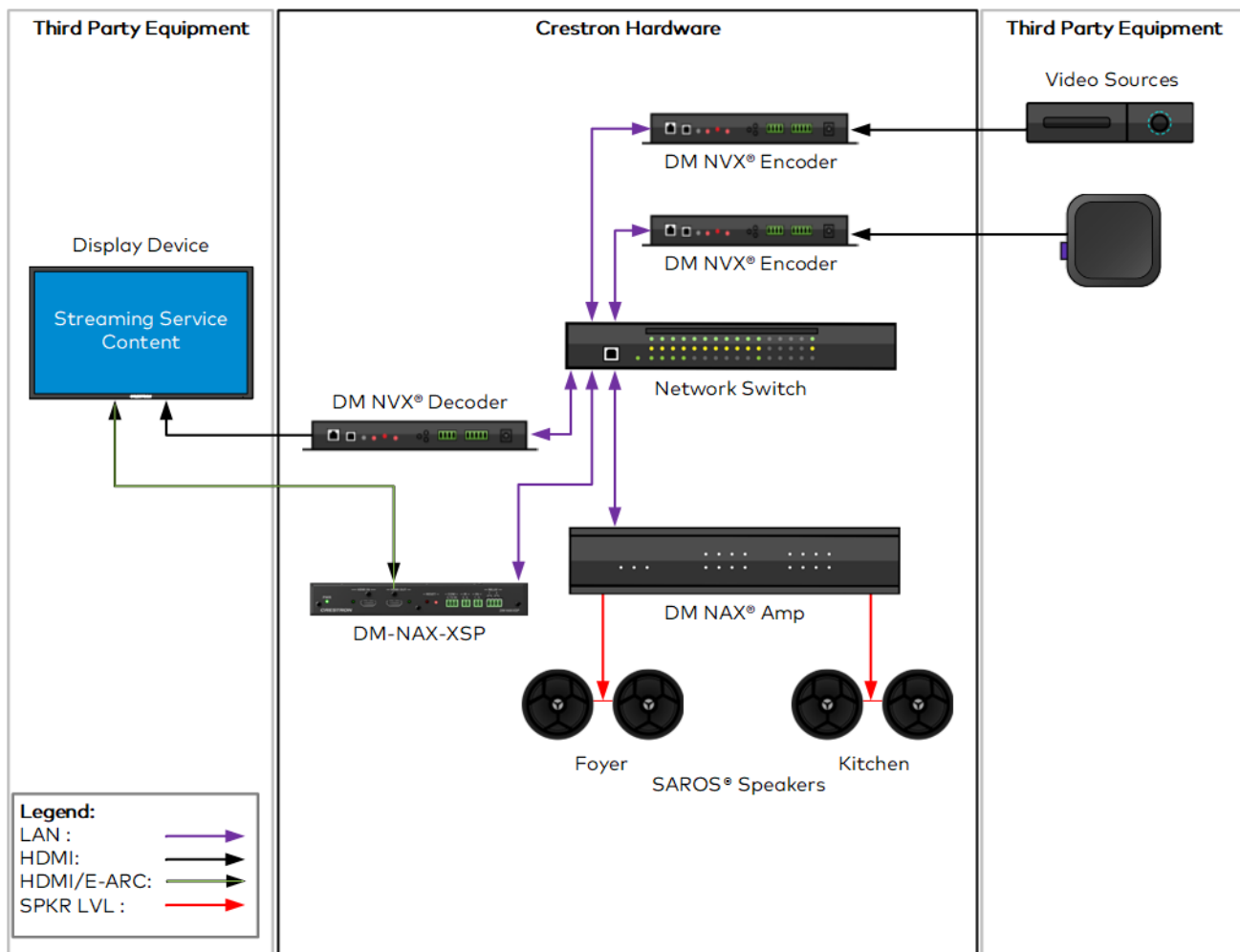

Preserving Surround Sound to Other DM-NAX-XSP Devices

In this scenario, the DM-NAX-XSP extracts surround sound audio from the display via eARC and sends it to another DM-NAX-XSP via the device's BTS stream functionality.

- The DM NVX® decoder at the display can receive either video source.
- The built-in streaming apps on the display can access cloud-based video content.
- Audio from either type of content (DM NVX A/V-over-IP or cloud-based) is received by the DM-NAX-XSP for extraction onto the Audio-over-IP network.
- Surround audio formats are preserved via the DM-NAX-XSP device's BTS stream, and an AVR distributes the surround channels to a surround sound speaker system.

This setup is ideal for extension of surround sound audio from cloud-based streaming services on the display to an AVR or home theater system over the network.

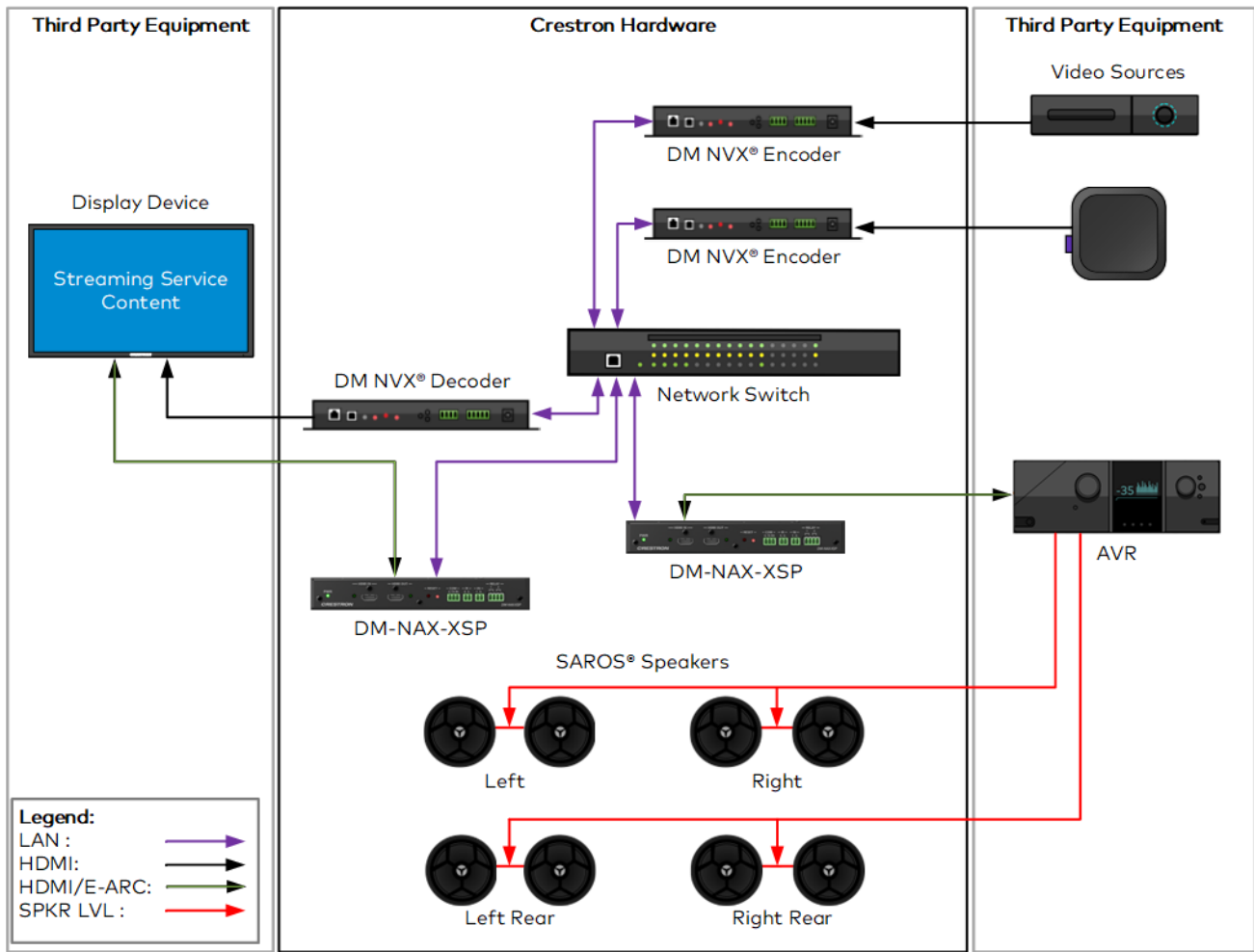

Installation

Refer to the following sections to install the DM-NAX-XSP.

- [In the Box on page 10](#)
- [Install the Device on page 11](#)
- [Connect the Device on page 16](#)
- [Observe the LED Indicators on page 17](#)
- [Reset the Device on page 18](#)

In the Box

Qty. Description

1 DM-NAX-XSP

Additional Items

- 2 Room Box Mounting Bracket (2057072)
- 4 Screw, 04-40 x 1/4 in. Pan Head, Philips (2007158)
- 4 Screw, 06-32 x 3/4 in. Steel, Truss (2009211)
- 4 Wall Anchor
- 2 Connector, 2-Pin (2003574)
- 1 Connector, 3-Pin (2003575)
- 1 Connector, 4-Pin (2003576)
- 4 Washer, Flat, Steel (2007644)

Install the Device

Refer to the [Safety Instructions](#) (Doc. 6607) prior to installation.

The device can be mounted to a wall, under a table, or installed on a single rack rail.

Connect the Mounting Brackets

Using the four included 4-40 x 1/4 in. Phillips pan head screws, attach the two included mounting brackets to the device.

- If mounting the device to a wall or a rack rail, orient the mounting brackets to be flush with the bottom face of the DM-NAX-XSP.

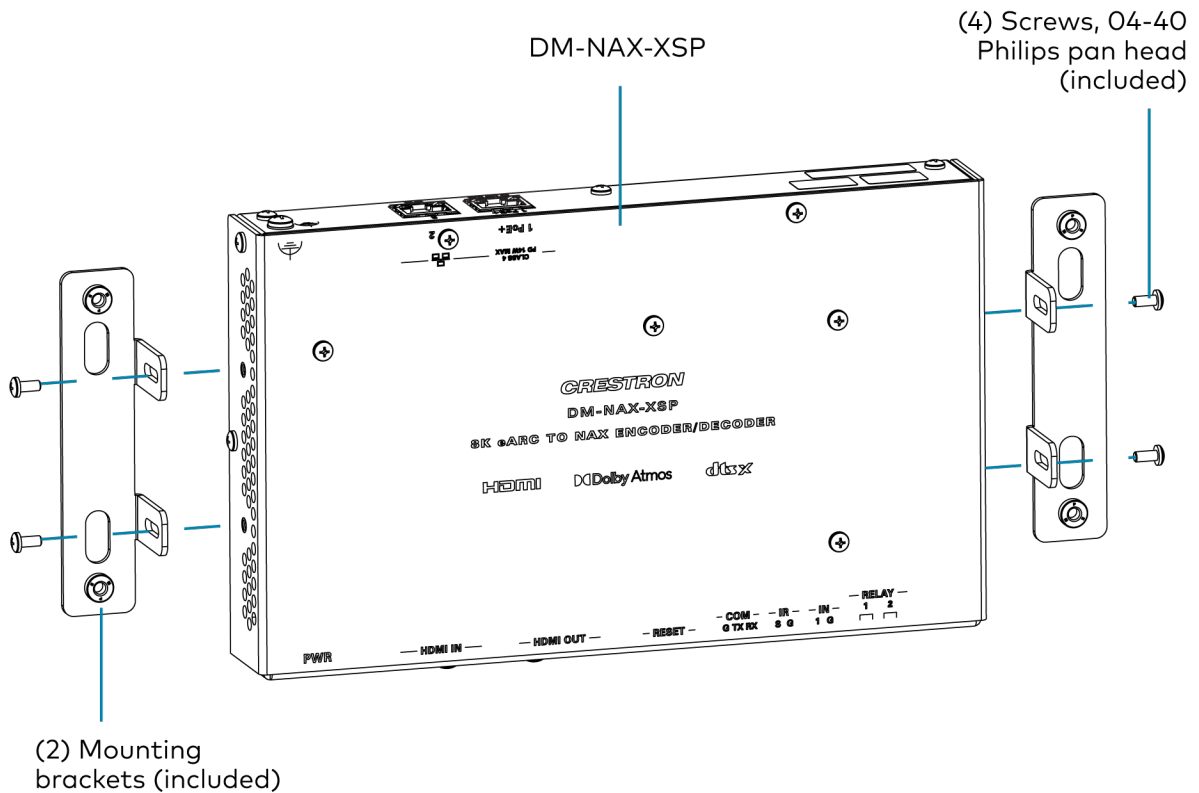

- If mounting the device under a table, orient the mounting brackets to be flush with the top face of the DM-NAX-XSP.

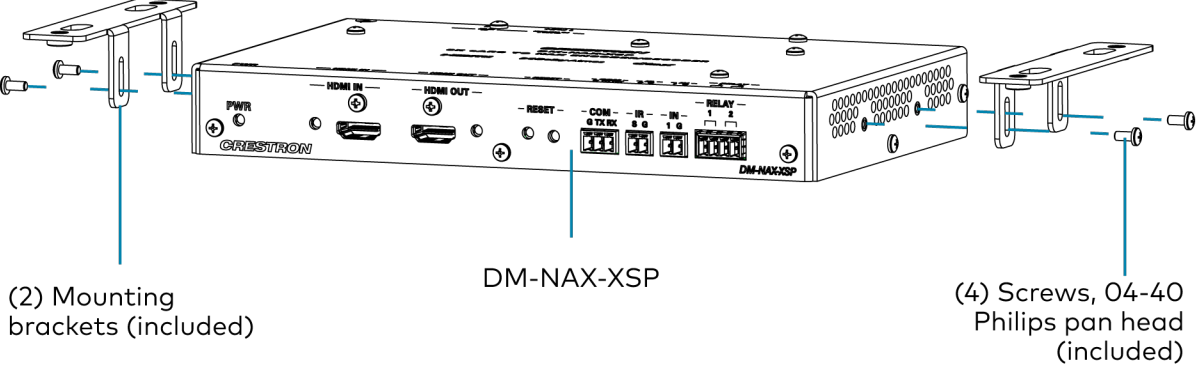

Mount to a Wall

To mount the device to a wall, use the four included sets of wall anchors, washers, and 6-32 x 3/4 in. Philips pan head screws.

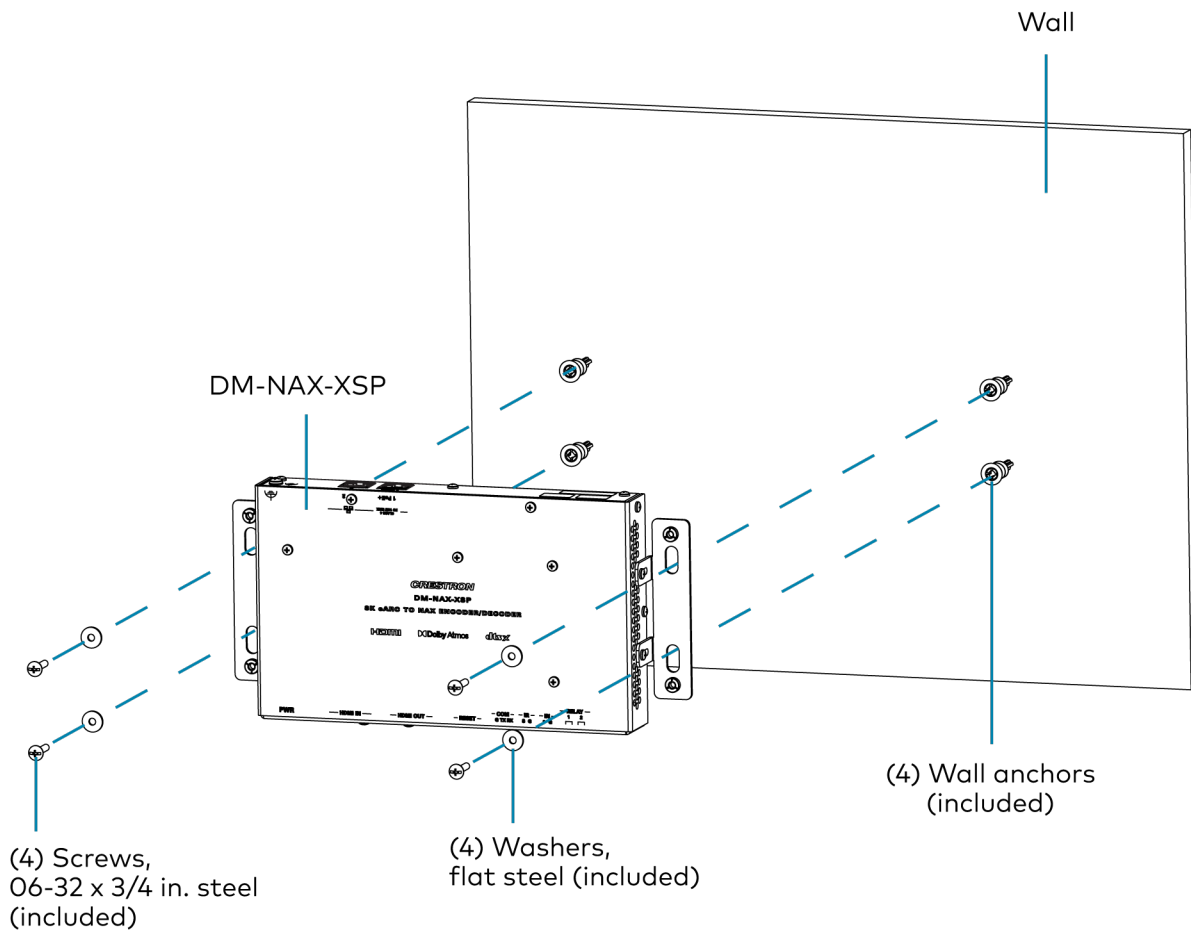

Mount under a Table

To mount the device under a table, use four 10-32 Philips pan head wood screws (not included).

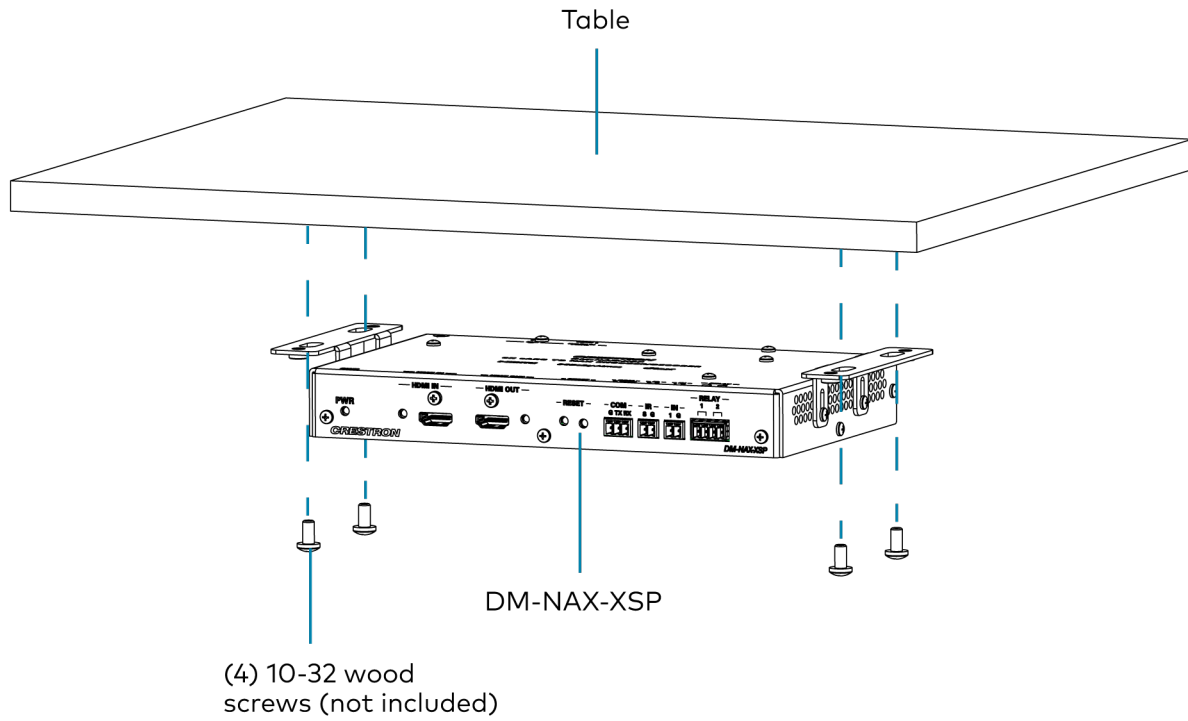

Install on a Rack Rail

To mount the device onto a front or rear rack rail:

1. Position one of the mounting brackets so that the holes align with the holes in the rack rail.
2. Secure the device to the rack rail using two 10-32 Philips pan head rack mount screws (not included).

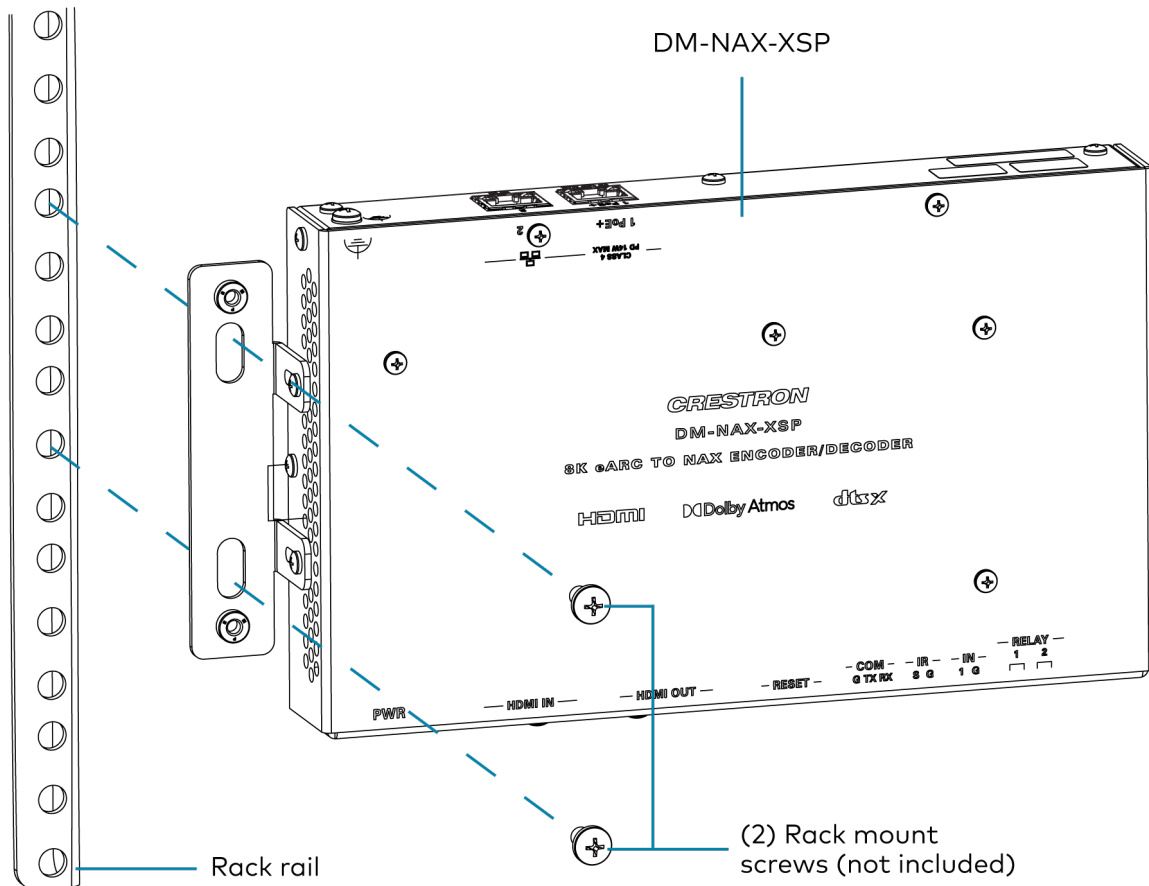

Rack Mounting Safety Precautions

Elevated Operating Ambient Temperature: If installed in a closed or multi-unit rack assembly, the operating ambient temperature of the rack environment may be greater than the room ambient temperature. Therefore, consideration should be given to installing the equipment in an environment compatible with the maximum ambient temperature (T_{ma}) specified by the manufacturer.

Reduced Airflow: Installation of the equipment in a rack should be such that the amount of airflow required for safe operation of the equipment is not compromised.

Mechanical Loading: Mounting of the equipment in the rack should be such that a hazardous condition is not achieved due to uneven mechanical loading.

Reliable Grounding: Reliable grounding of rack-mounted equipment should be maintained. Particular attention should be given to supply connections other than direct connections to the branch circuit (e.g., use of power strips).

Connect the Device

Make the necessary connections as called out in the following illustrations.

Front Panel

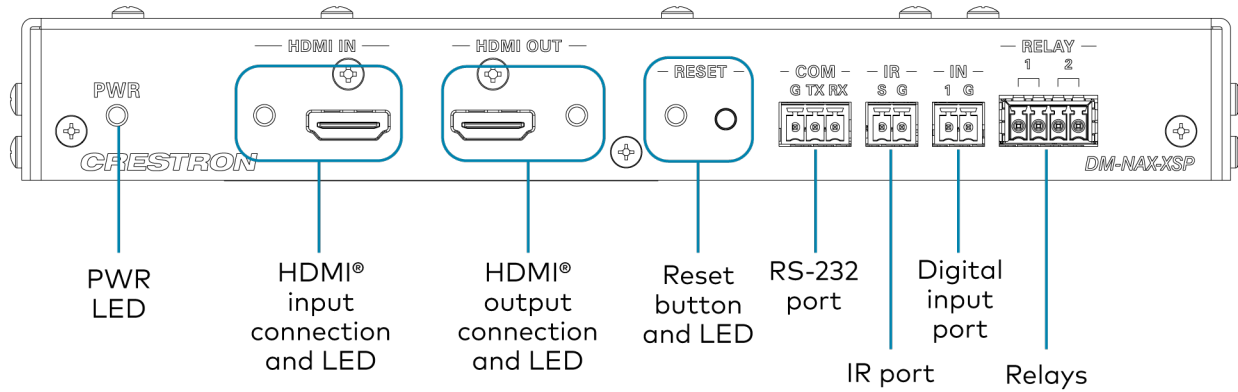

Rear Panel

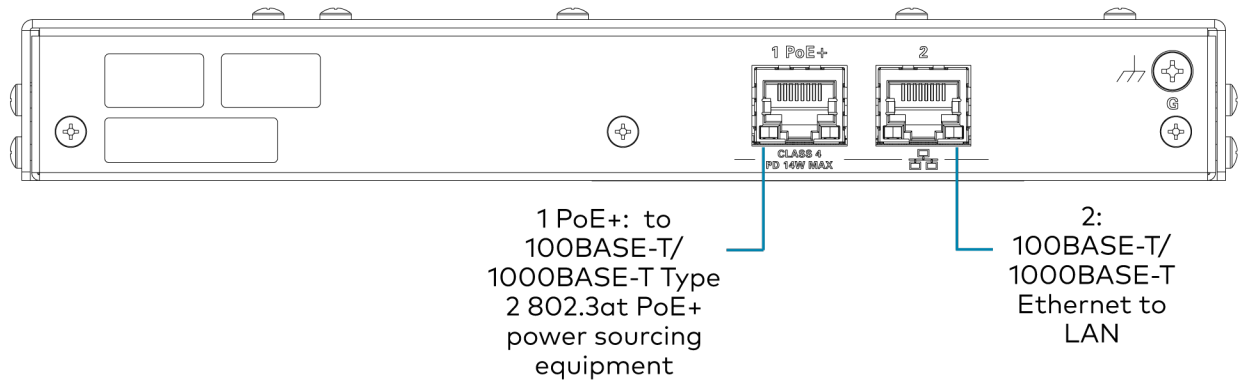

Observe the LED Indicators

Refer to the following table for information about the LED indicators on the device.

| LED Indicator | Color | Meaning |
|---------------|--------------|---|
| PWR | Green | Device is powered on and fully booted. |
| | Amber | Device is booting up. |
| | Off | Device is not powered on. |
| HDMI IN | Green | HDMI sync is detected with the source connected to the HDMI IN connector. |
| | Off | No HDMI sync is detected at HDMI IN . |
| HDMI OUT | Green | HDMI sync is detected with the display connected to the HDMI OUT connector. |
| | Off | No HDMI sync is detected at HDMI OUT . |
| RESET | Solid Red | The RESET button is pressed. |
| | Blinking Red | A network reset or factory restore has been initiated via the adjacent RESET button. |

Reset the Device

A network reset or factory restore may be performed when troubleshooting.

CAUTION: These procedures should only be performed as a last resort to recover an unresponsive device. Both the Network Reset and Factory Restore procedure will clear certain device settings that cannot be recovered once the procedure is complete. Before performing these procedures, please contact Crestron True Blue Support via phone, email or chat as described at www.crestron.com/support.

Network Reset

1. Ensure the device is powered on.
2. Press and hold the **RESET** button for up to 15 seconds until the **RESET** LED flashes red.

The device will reboot, and the default network settings will be reset. The device will revert to its default hostname, with DHCP enabled, and no static IP set.

Factory Restore

1. Turn off the device by disconnecting the power cable from the device.
2. Press and hold the **RESET** button and then reconnect the power cable while still holding the **RESET** button. Continue holding the **RESET** button for up to 30 seconds until the **RESET** LED flashes.

The device will reboot, and all the factory default settings will be restored, such as Zone settings, streaming service accounts, multicast addressing, etc.

CAUTION: Performing a factory restore will clear all settings from the device configuration.

Configuration

This section describes how to configure the DM-NAX-XSP.

Web Interface Configuration

The DM-NAX-XSP web interface allows you to view status information and configure network and device settings.

Access the Web Interface

To access the web interface, do either of the following:

- [Access the Web Interface with a Web Browser on page 20](#)
- [Access the Web Interface With the Crestron Toolbox™ Application on page 69](#)

The web interface is accessed from a web browser. The following table lists operating systems and their corresponding supported web browsers.

Operating System and Supported Web Browsers

| OPERATING SYSTEM | SUPPORTED WEB BROWSERS |
|---------------------------|--|
| Windows® operating system | Chrome™ web browser, version 31 and later Firefox® web browser, version 31 and later Internet Explorer web browser, version 11 and later Microsoft Edge web browser |
| macOS® operating system | Safari® web browser, version 6 and later Chrome web browser, version 31 and later Firefox web browser, version 31 and later |

Access the Web Interface with a Web Browser

1. Enter the IP address of the DM-NAX-XSP into a web browser.

NOTE: To obtain the IP address, use the **Device Discovery Tool** option in Crestron Toolbox™ application or an IP scanner application.

2. If you are creating a user account for the first time, do the following; otherwise, skip to step 3.
 - a. Enter a username in the **Username** field.
 - b. Enter a password in the **Password** field.
 - c. Re-enter the same password in the **Confirm Password** field.

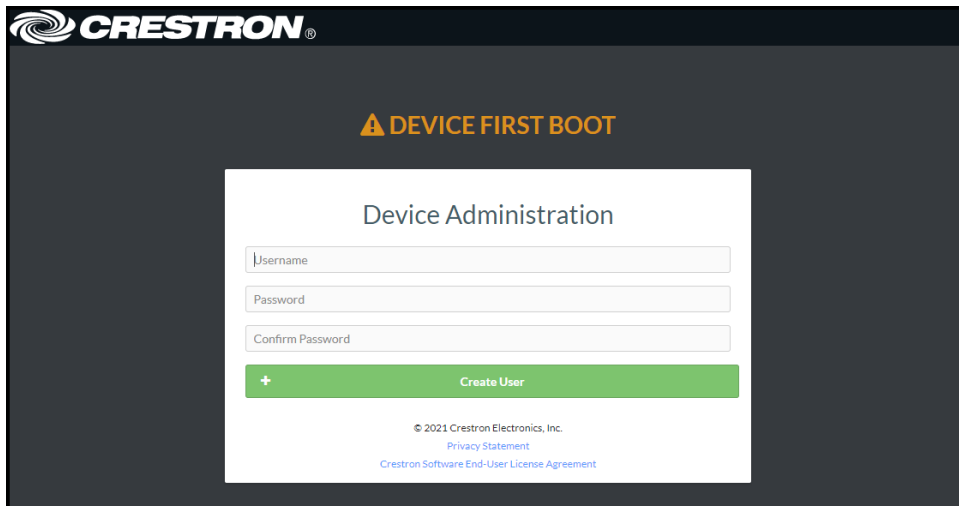

- d. Click **Create User**. The Device Administration page appears.

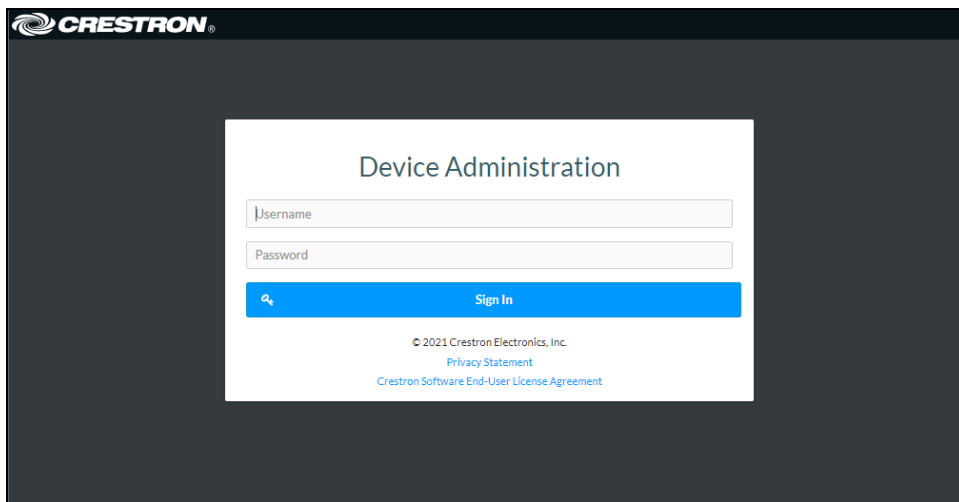

3. Enter the username in the **Username** field.
4. Enter the password in the **Password** field.
5. Click **Sign In**.

Action

The **Action** drop-down menu is displayed at the top right side of the interface and provides quick access to common device functions:

- Save Changes
- Revert
- Reboot
- Restore
- Update Firmware
- Download Logs
- Manage Certificates
- Manage EDIDs
- Manage Device Drivers
- Download Configuration
- Upload Configuration
- Manage Schedule

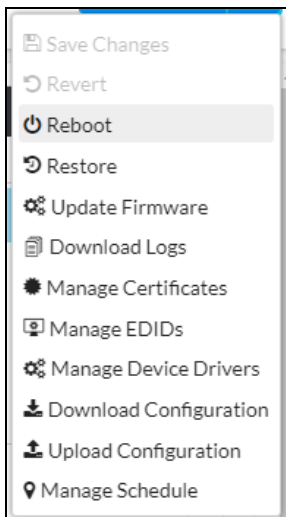

Save Changes

Click **Save Changes** to save any changes made to the configuration settings.

Revert

Click **Revert** to revert the device back to the last saved configuration settings.

Reboot the DM-NAX-XSP

Certain changes to the settings may require the DM-NAX-XSP to be rebooted to take effect. To reboot the device, do the following:

1. Click **Reboot** in the **Actions** drop-down menu. The **Confirmation** message box appears.

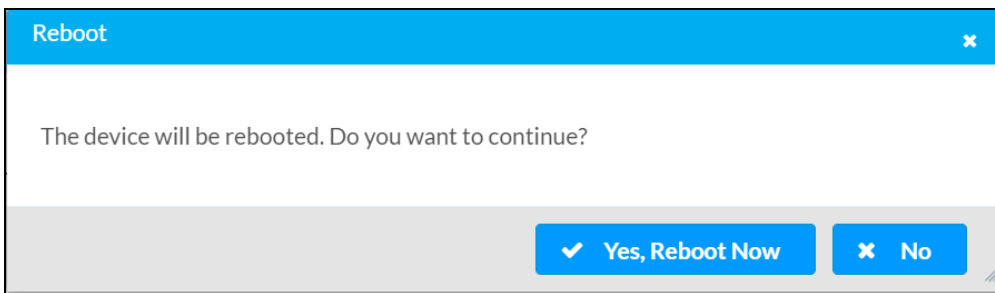

2. Click **Yes, Reboot Now** to reboot the device. The **Reboot** message box appears. Wait for the device reboot to complete before attempting to reconnect to the device.

Restore to Factory Default Settings

1. Click **Restore** in the **Actions** drop-down menu to restore the settings of the DM-NAX-XSP to factory defaults.

NOTE: When settings are restored, all settings, including the network settings, will revert to the factory default. If a static IP address is set, restoring the device to factory default settings will revert the IP address to the default DHCP mode.

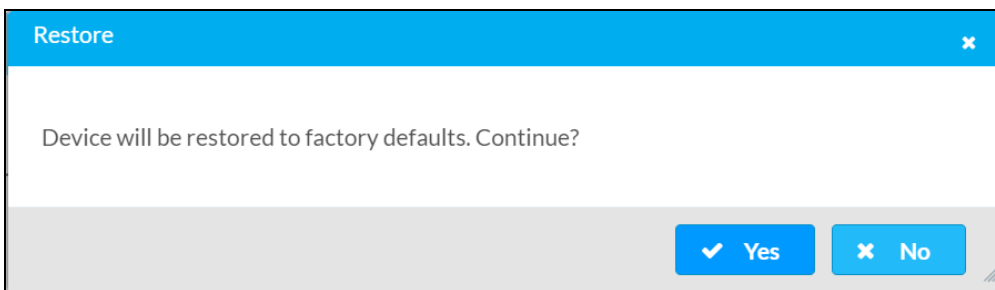

2. Click **Yes** in the **Confirmation** dialog to restore the DM-NAX-XSP to factory settings. Click **No** to cancel the restore operation.

A dialog is displayed again, indicating that the restore process was successful and that the device rebooted.

You can also restore to factory settings by pressing and holding the **RESET** button on the rear panel of the device with power disconnected then connect the power supply and continue to hold **RESET** button for 30 seconds.

Update Firmware

1. Click **Update Firmware** in the **Actions** drop-down menu.
2. In the **Firmware Upgrade** dialog, click **+ Browse**.

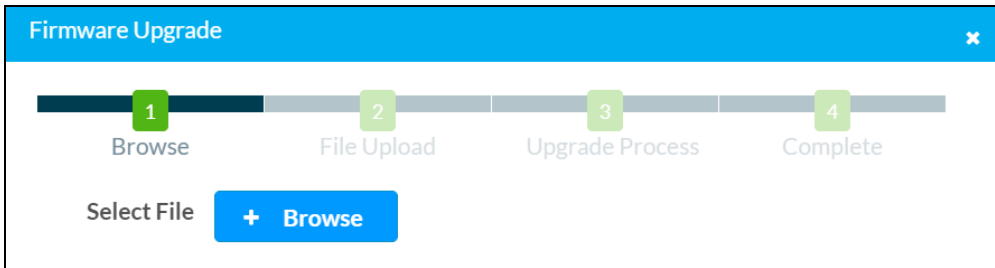

3. Locate and select the desired firmware file, and then click **Open**. The selected firmware file name is displayed in the **Firmware Upgrade** dialog.
4. Click **Load** and wait for the progress bar to complete and for the **OK** button in the message to become clickable.
5. Click **OK**. The device with new firmware can now be accessed.

Download Logs

1. Click **Download Logs** in the **Actions** drop-down menu to download the device message logs for diagnostic purposes.

The log file is downloaded to the Downloads folder of the PC.

Manage Certificates

Use the **Manage Certificates** window to add, remove, and manage certificates used in 802.1x and other protected networks.

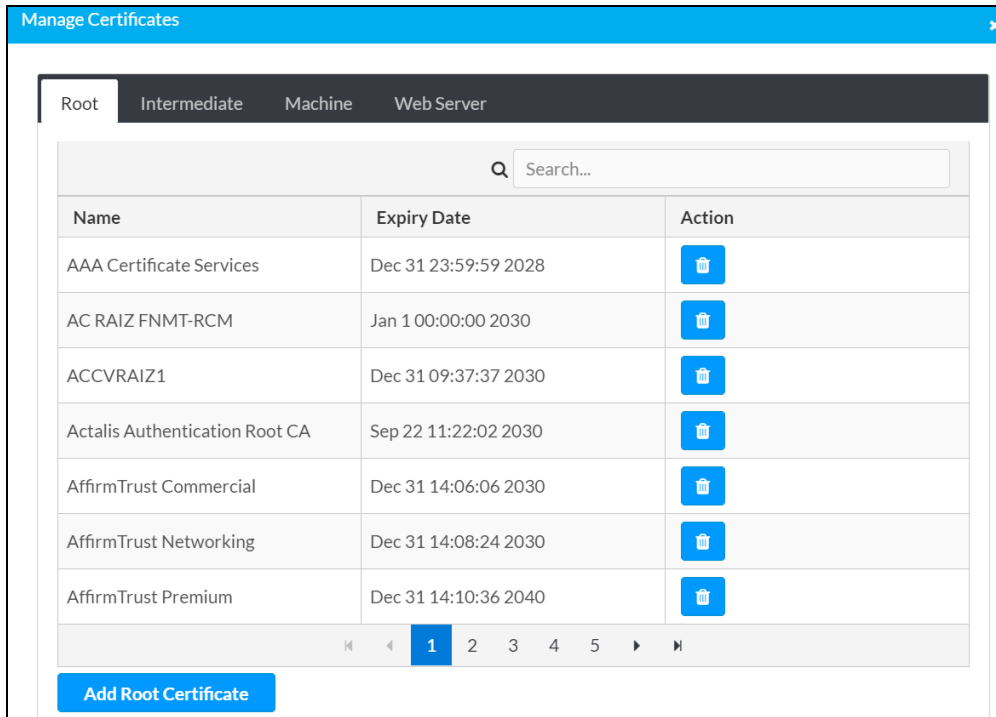

Click **Manage Certificates** in the **Actions** drop-down menu. The following certificate tabs are displayed:

- **Root:** The Root certificate is used by the DM-NAX-XSP to validate the network's authentication server. The DM-NAX-XSP has a variety of Root certificates, self-signed by trusted CAs (Certificate Authorities) preloaded into the device. Root certificates must be self-signed.
- **Intermediate:** The Intermediate store holds non self-signed certificates that are used to validate the authentication server. These certificates will be provided by the network administrator if the network does not use self-signed Root certificates.
- **Machine:** The machine certificate is an encrypted PFX file that is used by the authentication server to validate the identity of the DM-NAX-XSP. The machine certificate will be provided by the network administrator, along with the certificate password. For 802.1x, only one machine certificate can reside on the device.
- **Web Server:** The Web Server certificate is a digital file that contains information about the identity of the web server.

To Add Certificates

1. Click the corresponding certificate tab.
2. Click the **Add Root Certificate** button.
3. Click the **+ Browse** button.
4. Locate and select the file, and then click the **Open** button.

NOTE: If the certificate is a Machine Certificate, enter the password provided by the network administrator.

5. Click **OK**. This will add the certificate to the list box, displaying the file name and expiration date. The certificate is now available for selection and can be loaded to the device.

To Delete Certificates

1. Click the corresponding certificate tab.
2. Click the trashcan button () in the **Actions** column to delete the certificate.
3. Click **Yes** when prompted to delete the certificate or **No** to cancel the deletion.

Manage EDIDs

Use the **Manage EDIDs** window to add, remove, or browse which EDIDs are available for the HDMI input/output of the DM-NAX-XSP.

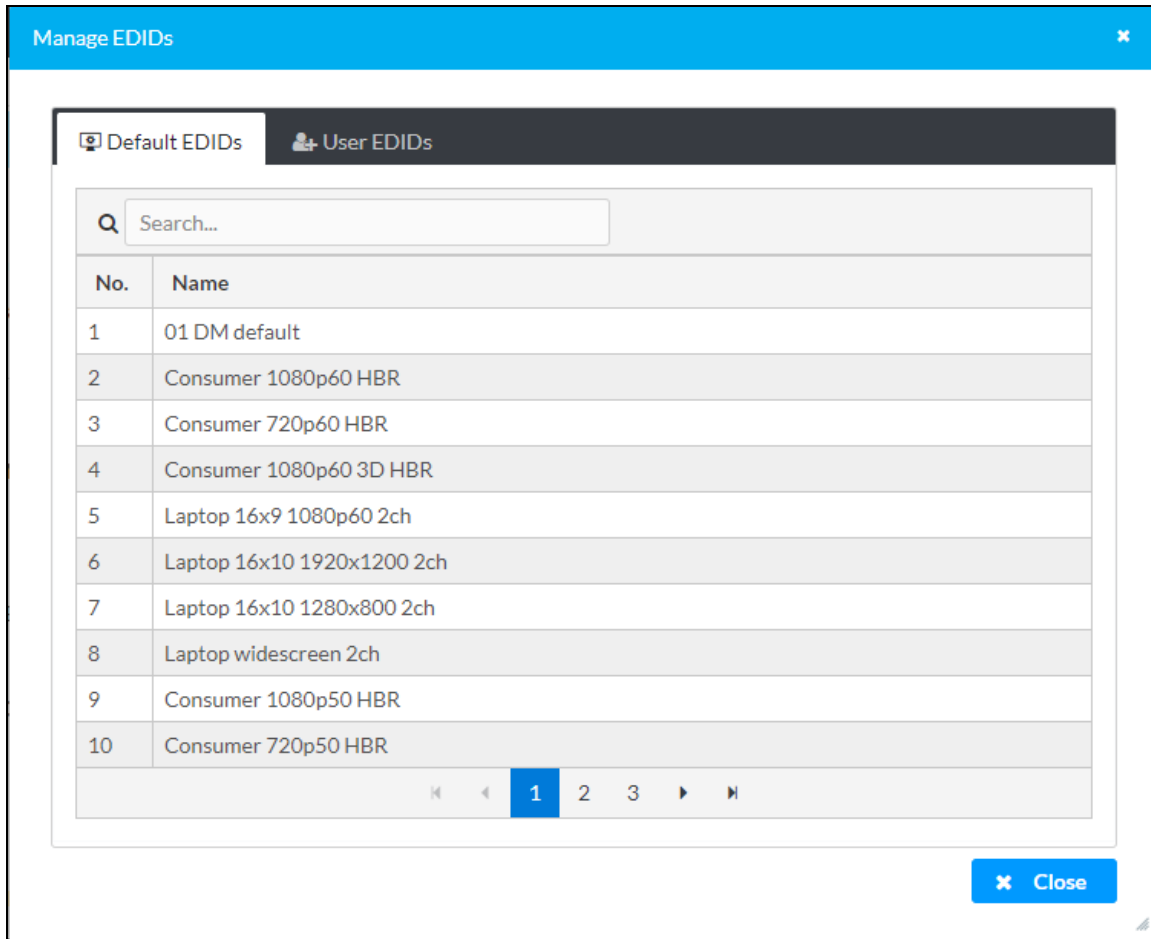

Click the **Manage EDIDs** entry in the Action Menu to open the **Manage EDIDs** window.

- The default tab that will open in this window is the **Default EDIDs** tab. This tab is read only, and provides a list of all default EDIDs available on the DM-NAX-XSP as part of the device firmware. Use the **Search...** text entry field to filter the list of EDIDs by name. Default EDIDs cannot be removed from the device.

- The second tab available in this window is the **User EDIDs** tab. Click on this tab to add or remove custom EDID files.

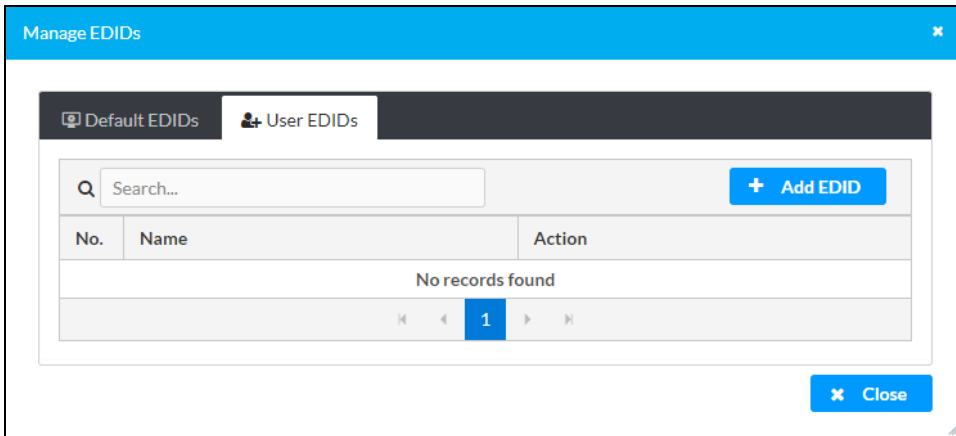

- By default, the table will populate with **No records found**. To add a custom EDID, click the **Add EDID** button at the top right of the table.
- The **File Upload** screen will appear. Browse for a .cedid file, then click **Upload** to upload it to the DM-NAX-XSP.

Browse and select a .cedid file

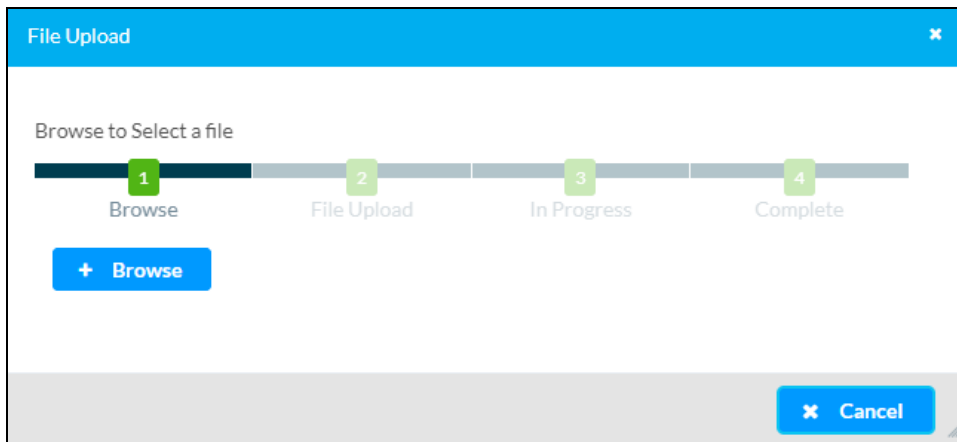

Upload the file

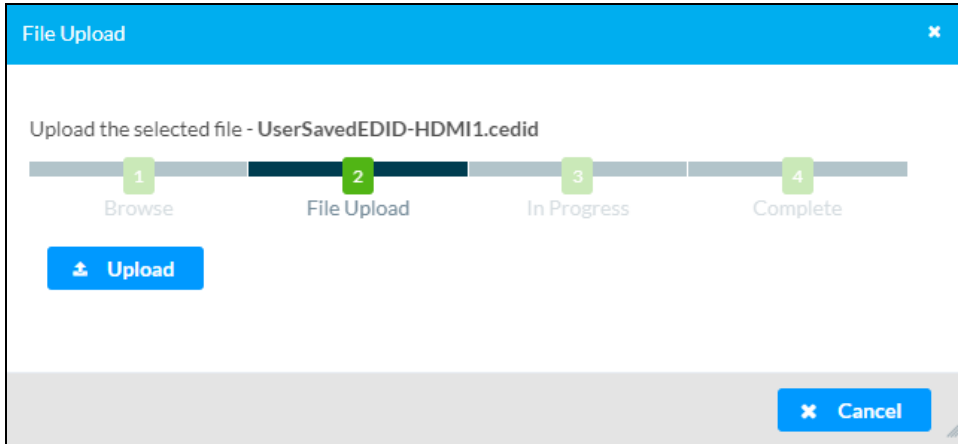

Wait for the file to upload to complete and click OK

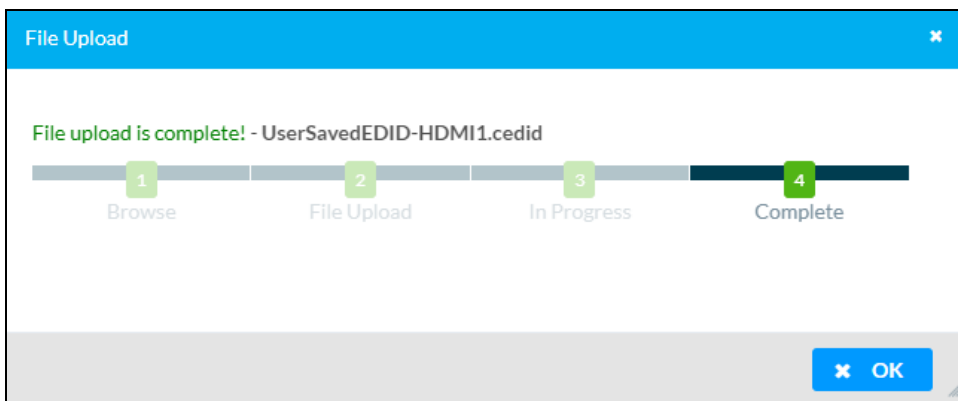

- Click the **OK** button to return to the **Manage EDIDs** window. The uploaded custom EDID will now be displayed in the table. To remove a custom EDID, click the **Delete** button in its table row.

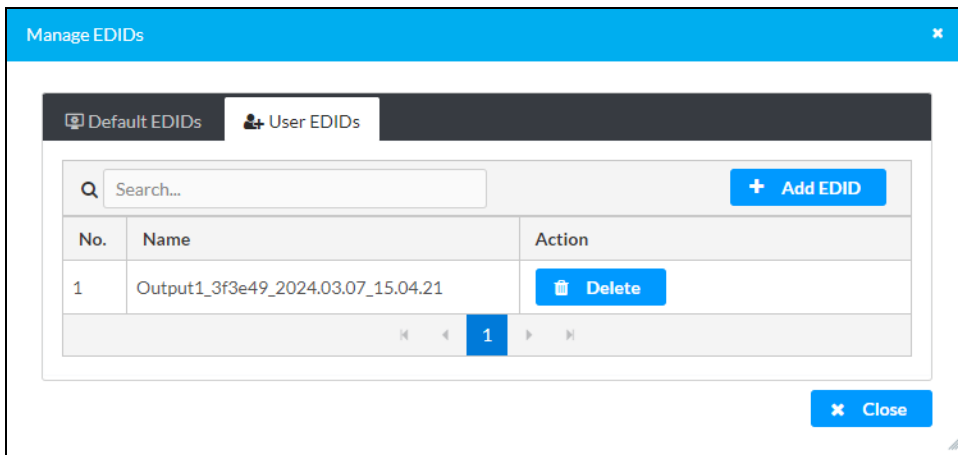

Manage Device Drivers

Use the **Manage Device Drivers** window to add, remove, or browse which drivers are available for controlling displays connected to the DM-NAX-XSP.

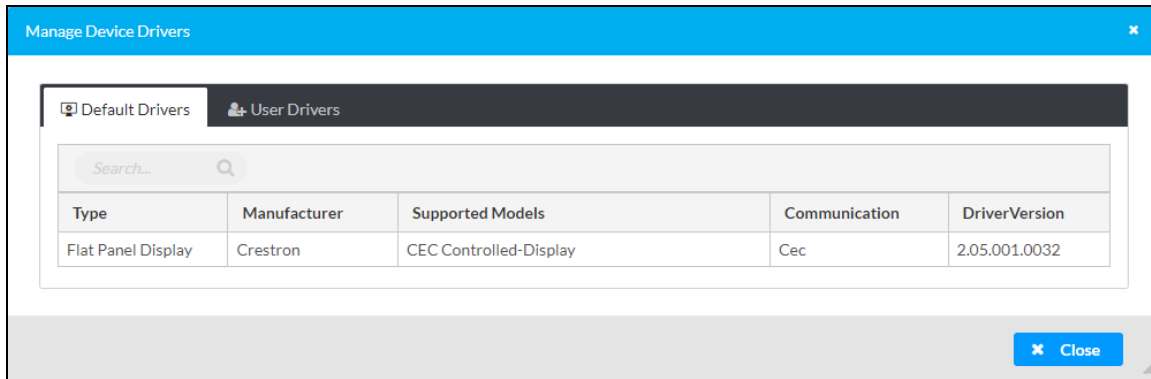

Click the **Manage Device Drivers** entry in the Action Menu to open the **Manage Device Drivers** window.

- The default tab that will open in this window is the **Default Drivers** tab. This tab is read only, and provides a list of all default drivers available on the DM-NAX-XSP as part of the device firmware. Use the **Search...** text entry field to filter the list of drivers by name. Default drivers cannot be removed from the device.
- The second tab available in this window is the **User Drivers** tab. Click on this tab to add or remove custom driver files.

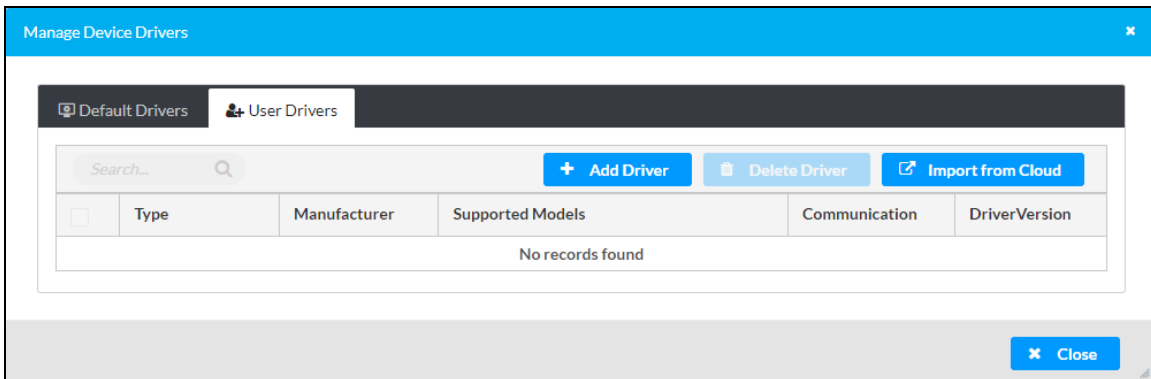

- By default, the table will populate with **No records found**. To add a custom driver, click either **Add Driver** or **Import from Cloud** at the top right of the table.
 - Clicking **Add Driver** opens a window for uploading a custom .pkg driver file that was created from the Device Learner utility in Crestron Toolbox software. Browse for a .pkg file and upload it to the DM-NAX-XSP.

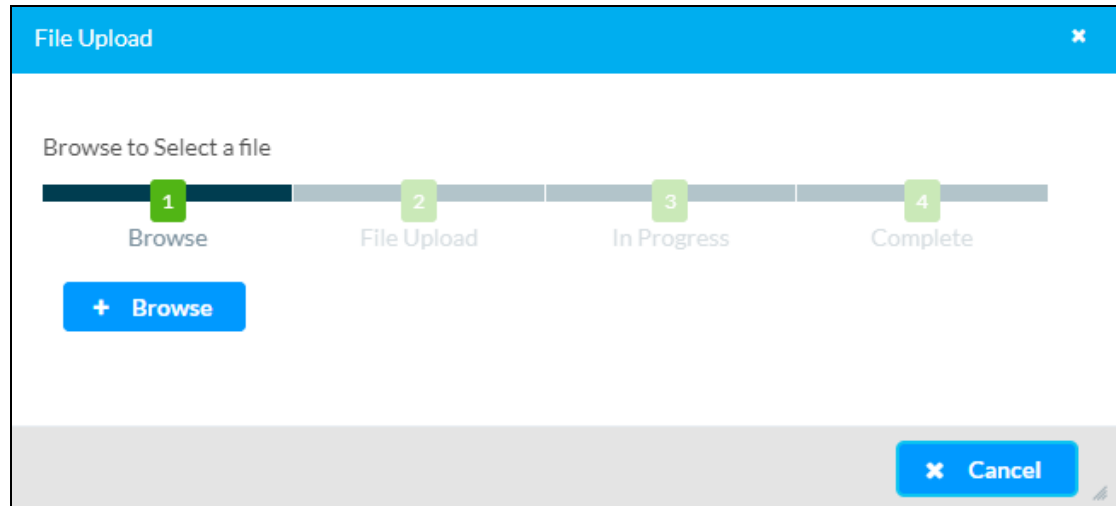

- Clicking **Import from Cloud** opens a window for browsing the [Crestron Driver Web Portal](#). Search the drivers list by manufacturer or model name, then click **Add** to download the driver file and add it to the DM-NAX-XSP.

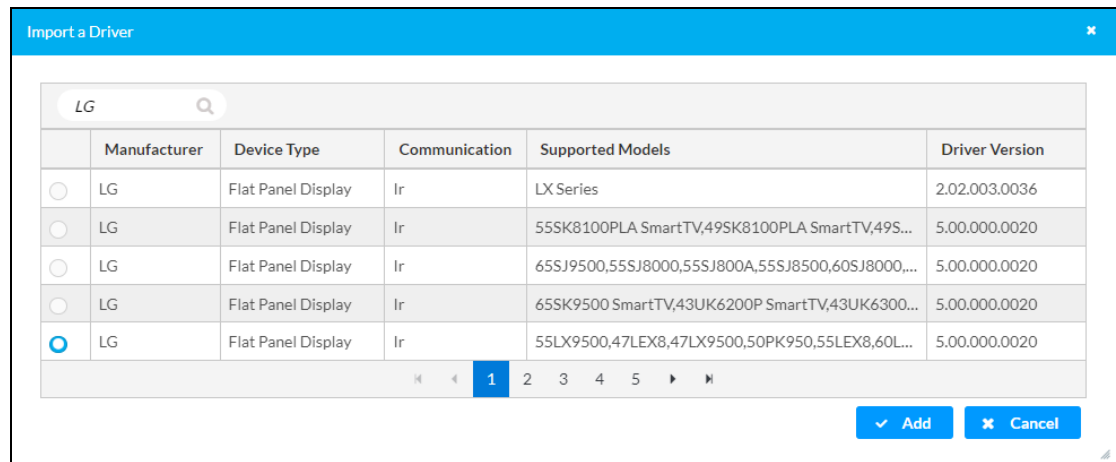

- Click the **OK** button to return to the **Manage Drivers** window. The uploaded custom driver will now be displayed in the table. To remove a custom driver, click the checkbox in its row and then the **Delete Driver** button.

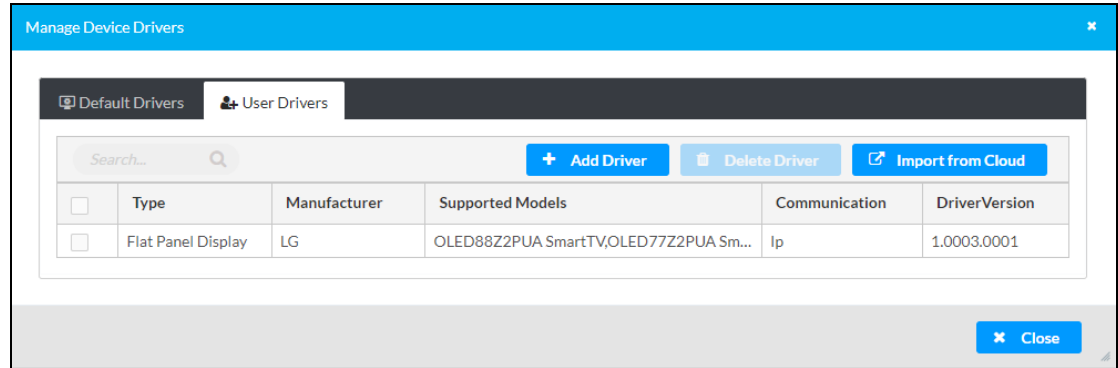

Download Configuration

Click **Download Configuration** to download a TGZ file containing the settings data for the DM NAX device.

NOTE: Multicast addresses, stream names, and user accounts for accessing the device are not saved in this configuration file.

Upload Configuration

- Click **Upload Configuration** to upload a TGZ file that will overwrite the current settings of the DM NAX device with a saved configuration.

CAUTION: Be sure to load a TGZ file for the same DM NAX device type while using the Load Configuration feature. For example, if loading a TGZ file to a DM-NAX-XSP, be sure that the TGZ file originated from a DM-NAX-XSP.

2. Click **Browse** to navigate to the desired TGZ file in your file browser. Double-click the file or highlight it and click **Open**.

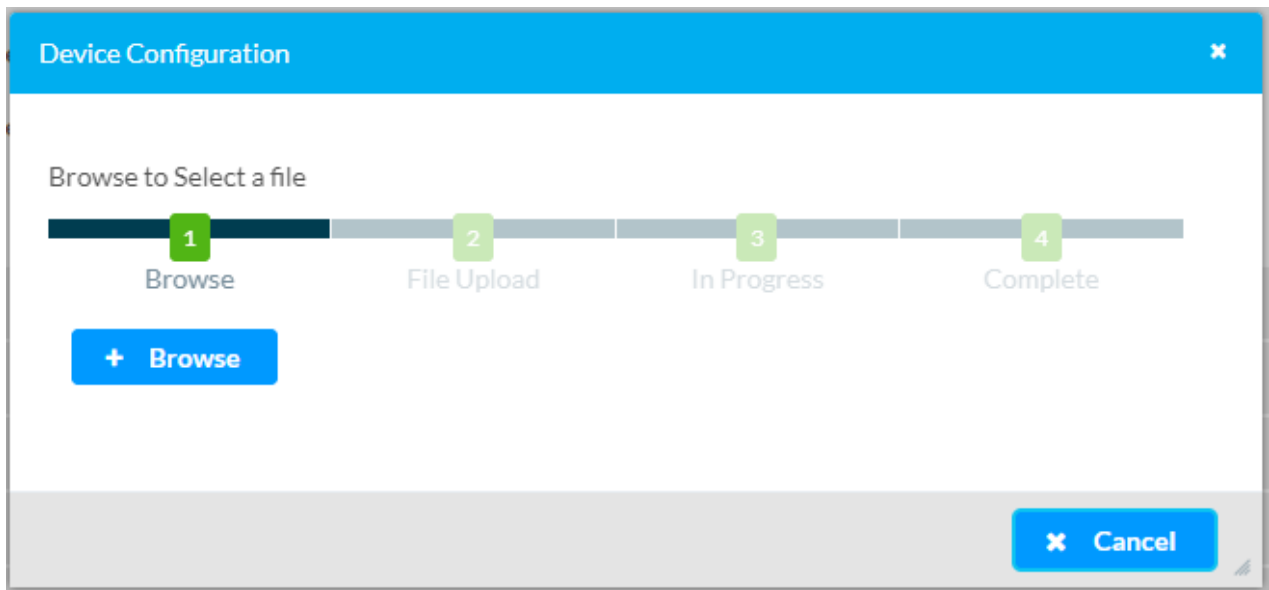

3. Click **Upload** to begin the file upload process. A progress bar will indicate the status of the configuration file upload.
4. Once the upload is complete, the device will require a reboot. Click **Yes, Reboot Now** to begin the reboot, or click **No** to return to the web UI.

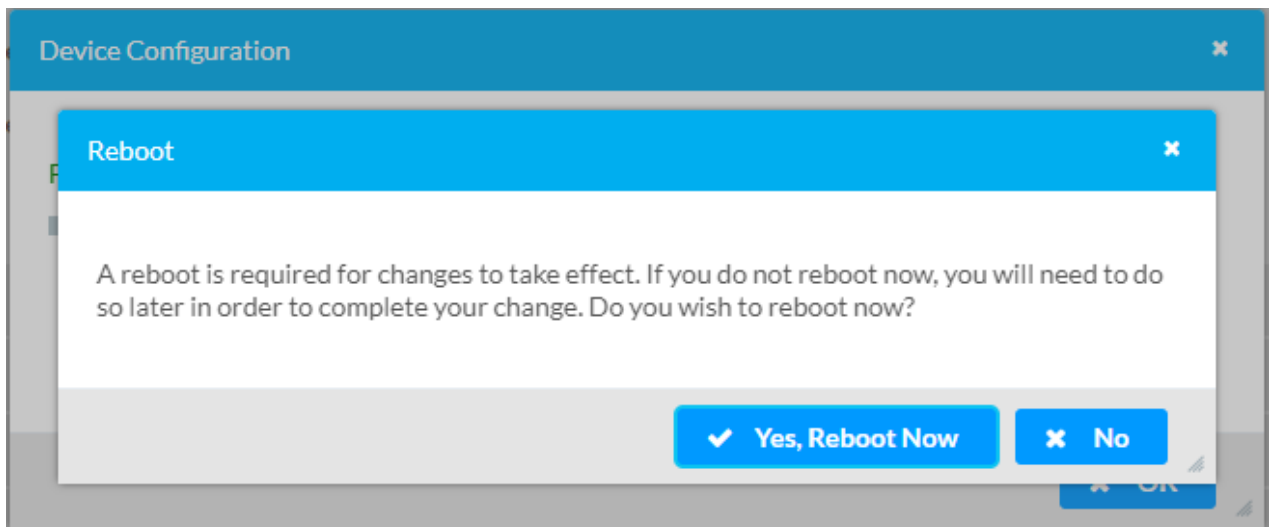

NOTE: Any changes made after the configuration file upload, but before a device reboot, may be overwritten when the device is rebooted.

Manage Schedule

Use the **Manage Schedule** window to add, edit, or remove schedules that can be used to power on or off connected displays.

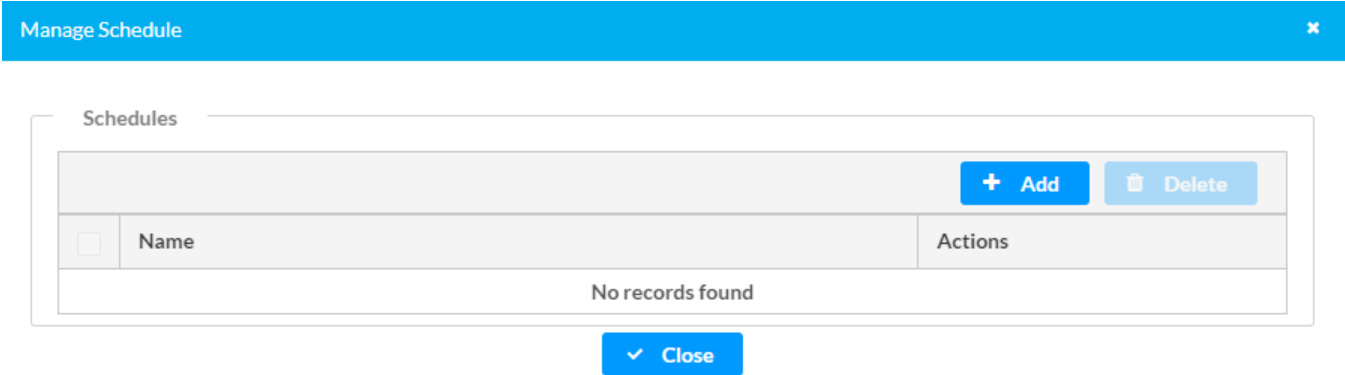

Click the **Manage Schedules** entry in the Action Menu to open the **Manage Schedules** window.

- By default, the table will populate with **No records found**. To add a schedule, click the **Add** button at the top right of the table.
 - Clicking **Add** opens a window for creating a custom schedule. Enter a name for the schedule in the **Name** text field at the top of the window. Each day of the week can be independently enabled or disabled. An hour range can be set for each enabled day. The **On Time** value determines when the power on command is sent to the display. The **Off Time** value determines when the power off command is sent.

Add Schedule

Name Name is required

| Enabled | Day | On Time | Off Time |
|-------------------------------------|-----------|------------------------------------|------------------------------------|
| <input checked="" type="checkbox"/> | Monday | <input type="text" value="00:00"/> | <input type="text" value="23:59"/> |
| <input checked="" type="checkbox"/> | Tuesday | <input type="text" value="00:00"/> | <input type="text" value="23:59"/> |
| <input checked="" type="checkbox"/> | Wednesday | <input type="text" value="00:00"/> | <input type="text" value="23:59"/> |
| <input checked="" type="checkbox"/> | Thursday | <input type="text" value="00:00"/> | <input type="text" value="23:59"/> |
| <input checked="" type="checkbox"/> | Friday | <input type="text" value="00:00"/> | <input type="text" value="23:59"/> |
| <input type="checkbox"/> | Saturday | <input type="text" value="00:00"/> | <input type="text" value="23:59"/> |
| <input type="checkbox"/> | Sunday | <input type="text" value="00:00"/> | <input type="text" value="23:59"/> |

- Click the **OK** button to return to the **Manage Schedules** window. The custom schedule will now be displayed in the table. Click the **Duplicate** button to duplicate the schedule. Click the **Edit** button to edit it. To delete a schedule, click the checkbox in its row and then the **Delete** button.

Manage Schedule

Schedules

| <input type="checkbox"/> | Name | Actions |
|--------------------------|------|--|
| <input type="checkbox"/> | Test | <input type="button" value="Edit"/> <input type="button" value="Duplicate"/> |

Status

The **Status** tab is the first page displayed when opening the interface of the DM-NAX-XSP. It displays general information about the DM-NAX-XSP (such as Model Name, Firmware Version, and Serial Number), current network settings (such as Host Name and IP Address, etc.), and input and output ports' current status.

The Status tab can be accessed at any time by clicking the **Status** tab of the DM-NAX-XSP interface.

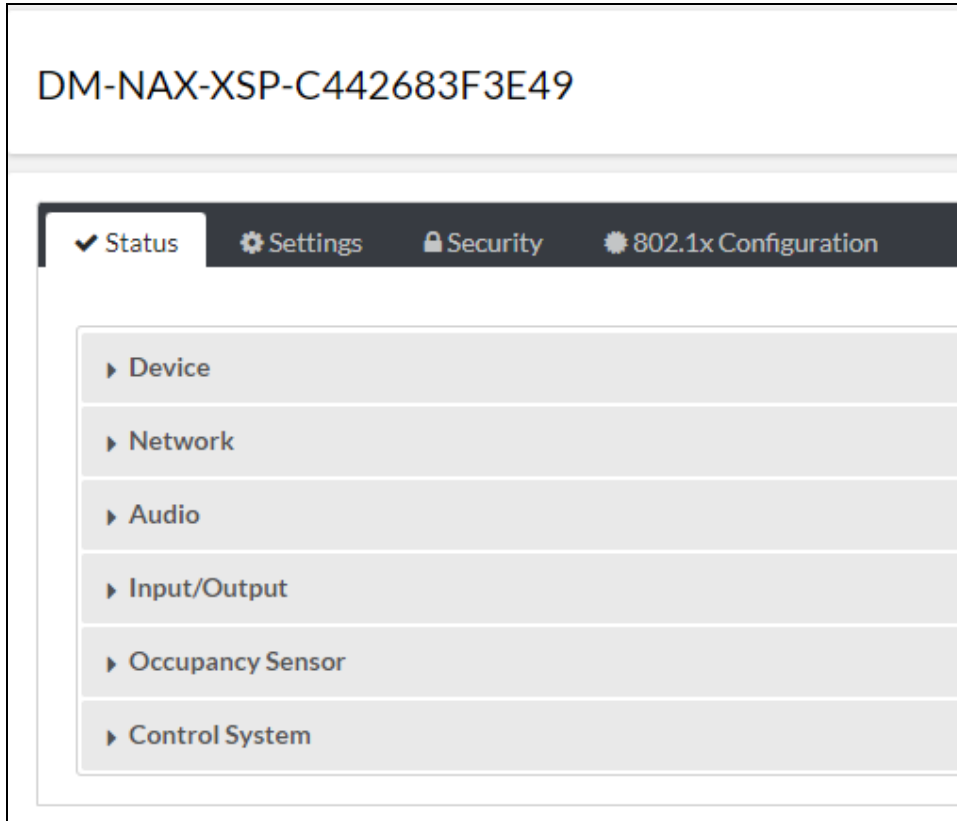

Information displayed on the **Status** tab is organized into different sections.

Device

The **Device** section displays the **Model**, **Firmware Version**, and **Serial Number** of the DM-NAX-XSP.

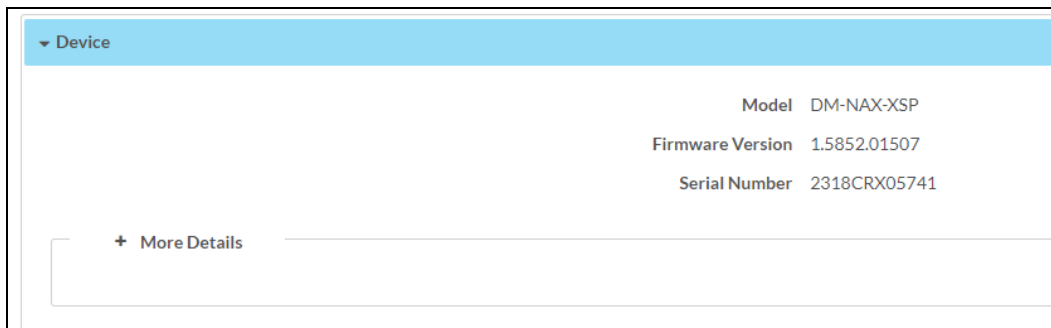

Click **+ More Details** to review additional information about the DM-NAX-XSP.

| | |
|----------------|----------------------|
| - More Details | |
| DM-NAX-XSP | 1.5852.01507 |
| Build | Jan 09 2024 (528287) |
| Updater | 1.5852.01507 |
| Bootloader | 2.01.125 |
| Cab | 1.8002.0082 |
| CCUI Version | 1.56.892867 |
| XIOSDK | 3.8.2 |
| IoTSDK | 1.10.1 |
| Build time | 01:50:43 |
| Product ID | 0x7240 |
| Revision ID | 0x0001 |

Network

The **Network** section displays network-related information about the DM-NAX-XSP, including the Hostname, Domain Name, and DNS Servers.

| | |
|----------------------|-------------------------|
| - Network | |
| Hostname | DM-NAX-XSP-C442683F3E49 |
| Domain Name | lan |
| Primary Static DNS | 192.168.1.1(DHCP) |
| Secondary Static DNS | |
| - Adapter 1 | |
| DHCP Enabled | On |
| IP Address | 192.168.1.92 |
| Subnet Mask | 255.255.255.0 |
| Default Gateway | 192.168.1.1 |
| Link Active | true |
| MAC Address | c4.42.68.3f.3e.49 |

NOTE: By default, the host name of the DM-NAX-XSP consists of the model name followed by the MAC address of the device. For example, DM-NAX-XSP-C442683F3E49.

Click **+ Adapter 1** to display an expanded section that shows additional information. If **+ Adapter 1** is selected, click **- Less** details to collapse the section.

NOTE: The **+ Adapter 2** option appears when the Ethernet ports on the DM-NAX-XSP are set to isolate traffic using the Port Selection feature.

Audio

The **Audio** section displays details about the active audio source of the DM-NAX-XSP.

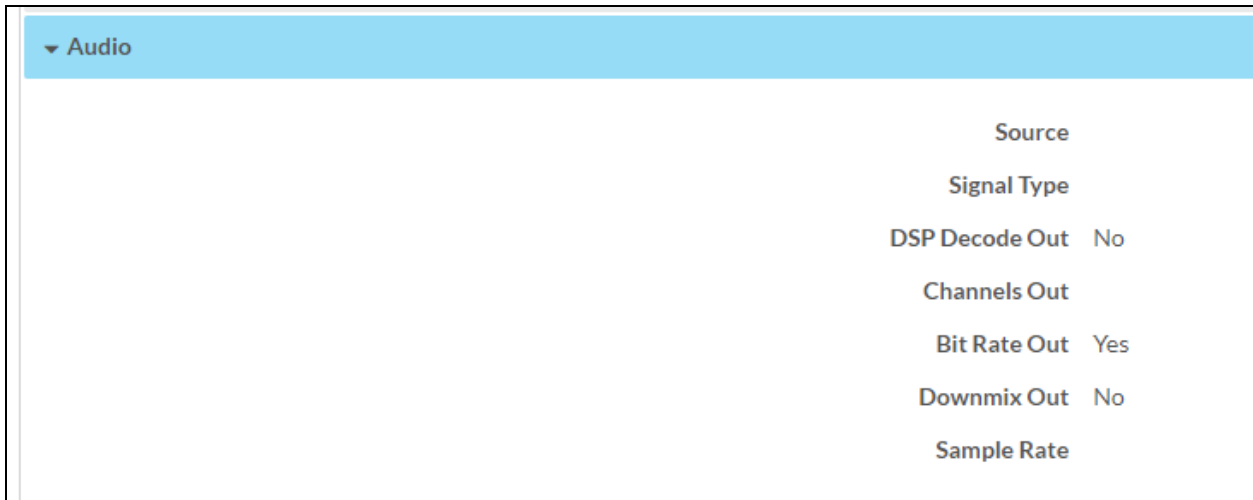

Information is only populated in this section for whichever audio input is selected as the active audio source. The active audio source is determined by the **Input / Output Selection** section of the **Settings** tab, or by commands issued by a control system.

Input/Output

The Input/Output section displays information on the available AV inputs and outputs of the DM-NAX-XSP.

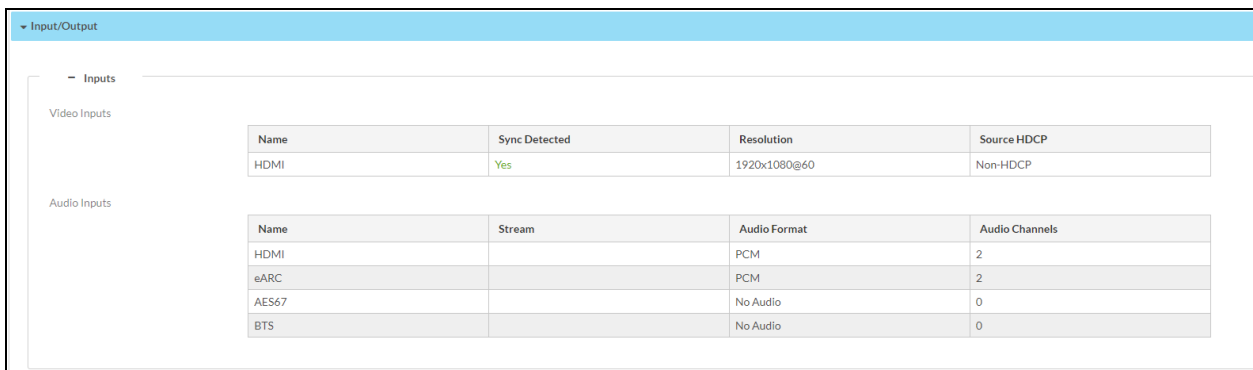

In the **Video Inputs** table, the **Sync Detected** status for the HDMI input displays whether or not a source is connected to the HDMI input. If sync is detected and a signal is passing, the **Resolution** and **Source HDCP** fields will also populate with information about the video signal.

In the **Audio Inputs** table, each available audio input on the device has a row. the **Stream**, **Audio Format**, and **Audio Channels** columns will each populate with information about the audio signal for a given input when an audio signal is detected.

Occupancy Sensor

The **Occupancy Sensor** section displays information on any occupancy sensors paired with the DM-NAX-XSP.

| Occupancy Sensor | | | | | | |
|-------------------|---------|---------------|------------------|--------|-----------|--|
| - Ethernet Models | | | | | | |
| Name | Model | Serial Number | Firmware Version | Status | Occupancy | |
| Occupancy Sensor | POE-OCC | 1949CRO01448 | 3.0000.00011 | Online | Occupied | |
| - Digi-In Models | | | | | | |
| Name | | Digi-In Port | | | | |
| DigiInSensor2 | | 01 | | | | |

Occupancy sensors can be paired with the device using the **Occupancy Sensor** section of the **Settings** tab.

The Ethernet Models table displays the **Name**, **Model**, **Serial Number**, and **Firmware Version** of any paired IP based occupancy sensors. The **Status** field will either read **Online** or **Offline**. The **Occupancy** field will either read **Occupied** or **Vacant**. The **Name** field is populated with the friendly name entered while pairing the occupancy sensor, while the other fields populate based on information pulled from the occupancy sensor. Up to three IP based occupancy sensors can be paired with the DM-NAX-XSP.

Control System

The **Control System** section displays connection information, consisting of the following:

| Encrypt Connection ON | | | | | | |
|-----------------------|---------|---------------------|------|-------------|------------|--------|
| IP ID | Room ID | IP Address/Hostname | Type | Server Port | Connection | Status |
| 7 | | MC4-R-00107F9CA5C1 | Peer | 41796 | Gway | ONLINE |

- **Encrypt Connection:** Reports **ON** or **OFF**
- **IP ID:** Reports the currently used IP ID of the DM-NAX-XSP
- **Room ID:** Reports the room ID
- **IP Address/Hostname:** Reports the IP address or hostname of the control system
- **Type:** Reports the type of IP table entry the device holds in the control system's table; the DM-NAX-XSP will always report as a **Peer** entry in the control system's table
- **Server Port:** Reports the port number for the connection to the control system
- **Connection:** Reports the type of connection the device is using to communicate with the control system; the DM-NAX-XSP will always report a **Gway** connection
- **Status:** Reports **OFFLINE** or **ONLINE**.

Settings

This section provides the following information:

- [System Setup on page 40](#)
- [Occupancy Sensor on page 45](#)
- [Port Selection on page 46](#)
- [Input / Output Selection on page 47](#)
- [DM NAX Streams on page 54](#)

The **Settings** tab enables you to configure the DM-NAX-XSP settings. The Settings page can be accessed at any time by clicking the **Settings** tab of the DM-NAX-XSP interface.

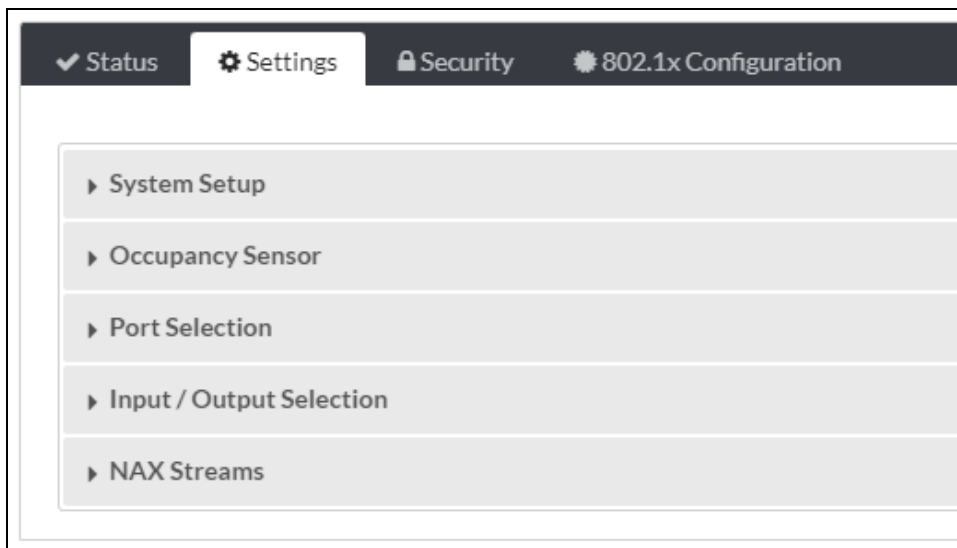

Settings available on the **Settings** tab are organized into different sections.

System Setup

The **System Setup** section contains settings for **Network**, **Cloud Settings**, **Auto Update**, **Date/Time**, and **Control System**.

Network

The **Network** section contains network-related settings for the DM-NAX-XSP, including the Hostname, Domain, Primary Static DNS, and Secondary Static DNS.

System Setup

Network Cloud Settings Auto Update Date/Time Control System

Network

Adapter 1

Hostname * DM-NAX-XSP-C442683F3E49

Domain lan

Primary Static DNS 192.168.1.1(DHCP)

Secondary Static DNS

DHCP

IP Address 192.168.1.92

Subnet Mask 255.255.255.0

Default Gateway 192.168.1.1

NOTE: By default, the hostname of the DM-NAX-XSP consists of the model name followed by the MAC address of the device. For example, DM-NAX-XSP-C442683F3E49.

Adapter 1

The Adapter 1 subheading contains settings for DHCP, IP Address, Subnet Mask, and Default Gateway of Ethernet adapter 1 on the rear panel of the device.

NOTES:

- An **+ Adapter 2** option only appears when the Ethernet ports on the DM-NAX-XSP are set to isolate traffic using the Port Selection feature. The settings for Adapter 2 are identical to those available for Adapter 1.
- Internal processes of DM NAX devices use IP addresses in the 10.10.10.xxx range. This IP range should be avoided when addressing DM NAX devices to prevent conflicts with these internal addresses.

Set the **DHCP** toggle to enabled (right) or disabled (left) to specify whether the IP address of the DM-NAX-XSP is to be assigned by a DHCP (Dynamic Host Configuration Protocol) server.

- **Enabled:** When DHCP is enabled (default setting), the IP address of the DM-NAX-XSP is automatically assigned by a DHCP server on the local area network (LAN).
- **Disabled:** When DHCP is disabled, manually enter information in the following fields:
 - **Primary Static DNS:** Enter a primary DNS IP address.
 - **Secondary Static DNS:** Enter a secondary DNS IP address.

- **IP Address:** Enter a unique IP address for the DM-NAX-XSP.
- **Subnet Mask:** Enter the subnet mask that is set on the network.
- **Default Gateway:** Enter the IP address that is to be used as the network's gateway.

To save any new network entries, click **Save Changes**.

Cloud Settings

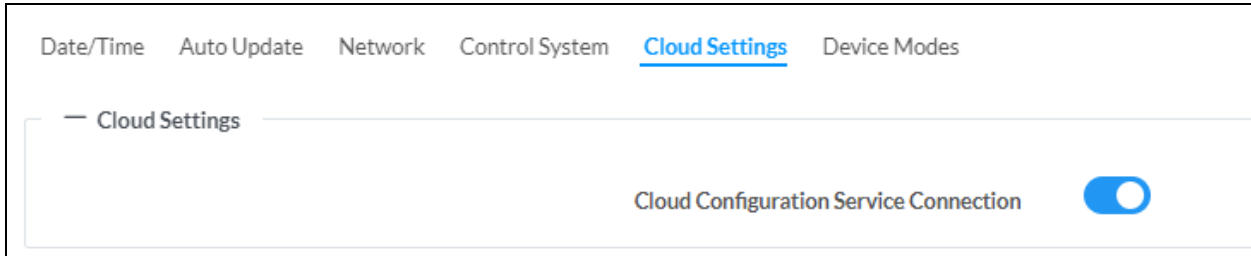

Set the **Cloud Settings** toggle to enabled (right) or disabled (left) to specify whether the DM-NAX-AUD-IO can communicate with the XiO Cloud® platform.

Auto Update

The DM-NAX-XSP can automatically check for and install firmware updates at scheduled intervals via the Auto Update feature.

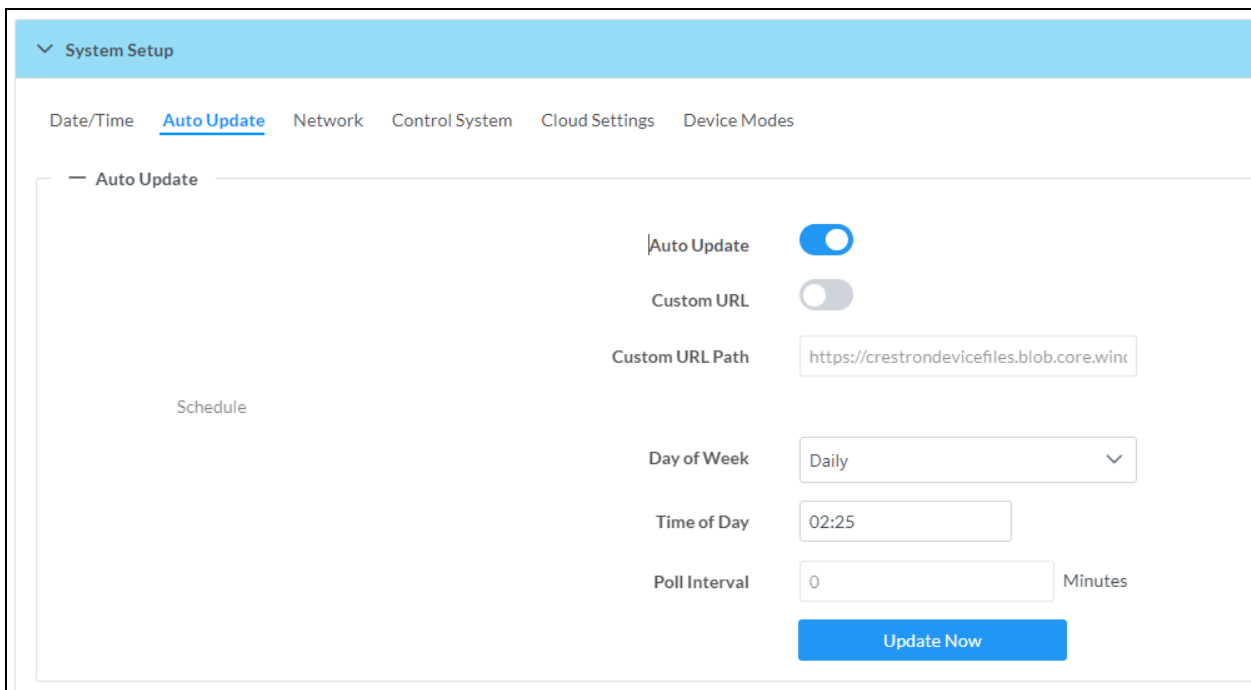

1. Set the **Auto Update** toggle to the right position to enable Auto Update.
2. Define the URL to download the updates by doing either of the following:

- a. Use the default URL to download the updates from the Crestron server.
 - b. Use a custom URL. Set the **Custom URL** toggle to the right position to enable a custom URL. In the **Custom URL Path** text box, enter the path to a custom manifest file in the FTP or SFTP URL format. Use the Crestron Auto Update Tool to generate a custom manifest file, then store the file on an FTP (File Transfer Protocol) or SFTP (Secure File Transfer Protocol) server.
3. Set a schedule for the automatic firmware update by doing either of the following:
 - a. Select the desired **Day of Week** and **Time of Day** (24-hour format) values.
 - b. Set the **Poll Interval** by entering a value from **60** to **65535** minutes. A value of **0** disables the Poll Interval.
 4. Click **Save Changes**.

Clicking **Update Now** causes the device to check for a firmware update immediately. If a schedule was set in step 4 above, that schedule still remains in effect.

Date/Time

Use the **Date/Time** section to configure the date and time settings of the DM-NAX-XSP.

The screenshot shows the 'Date/Time' configuration page. It includes a 'Synchronization' section with a 'Time Synchronization' toggle set to 'On' and a 'Synchronize Now' button. Below is a table for 'NTP Time Servers' with one entry: 'pool.ntp.org' on port '123' with 'None' authentication. At the bottom, the 'Configuration' section shows 'Time Zone' set to '(UTC-05:00) Eastern Time (US & Can)', 'Date' as '02/21/2024', and 'Time' as '11:49'.

| | Address | Port | Authentication Method | Authentication Key | Key ID |
|--------------------------|--------------|------|-----------------------|--------------------|--------|
| <input type="checkbox"/> | pool.ntp.org | 123 | None | ***** | 0 |

Configuration

Time Zone: (UTC-05:00) Eastern Time (US & Can)

Date: 02/21/2024

Time: 11:49

Time Synchronization

1. Set the **Time Synchronization** toggle to the right position to enable or left position to disable time synchronization. By default, time synchronization is enabled.
2. In the **NTP Time Servers** table, enter the URL of a NTP (Network Time Protocol) or SNTP (Simple Network Time Protocol) server. Up to three time servers can be added on a device.
3. Click **Synchronize Now** to perform time synchronization between the device's internal clock and the time server.

Time Configuration

1. Click on the **Time Zone** drop-down menu to select the applicable time zone.
2. In the **Date** field, enter the current date.

3. In the **Time (24hr Format)** field, enter the current time in 24-hour format.

Click the **Save Changes** button to save the settings.

Click **Revert** from the **Actions** drop-down menu to revert to the previous settings without saving.

Control System

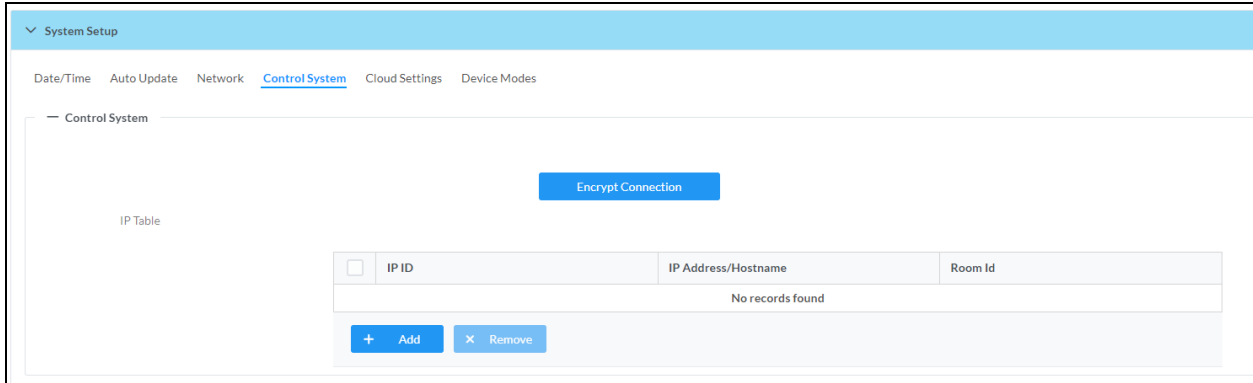

1. Click the **Encrypt Connection** button to navigate to the **Security** tab to configure encryption settings.
2. Enter the username in the **Control System Username** field.
3. Enter the password in the **Control System Password** field.
4. Enter the Room ID in the **Room ID** field.
5. Enter the IP ID of the DM-NAX-XSP in the **IP ID** field.
6. Enter the IP address or hostname of the control system in the **IP Address/Hostname** field.
7. Click the **Save Changes** button to save the new entries. The Control System Save message box appears, indicating that the control system settings were saved successfully. Click the **Revert** button to revert to the previous settings without saving.

Occupancy Sensor

Use the **Occupancy Sensor** section to pair up to three Ethernet based and one digital input based occupancy sensor.

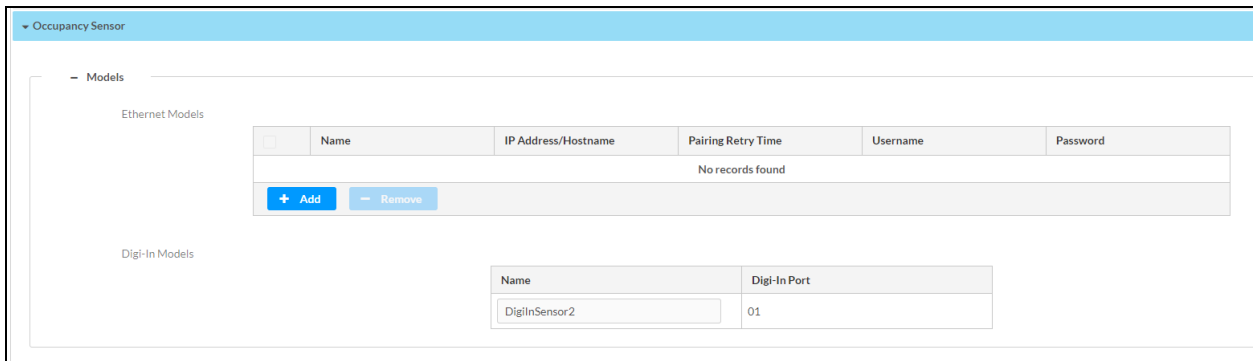

The **Ethernet Models** table contains all settings for pairing Ethernet based occupancy sensors.

To pair an Ethernet occupancy sensor:

1. Click the **Add** button.
2. Enter a friendly name for the occupancy sensor in the **Name** text field.
3. Enter the IP address or hostname of the occupancy sensor in the **IP Address/Hostname** field.

4. Select a **Pairing Retry Time** from the drop-down menu. The options are from one to five minutes. If the DM-NAX-XSP loses connection to the occupancy sensor, this interval will determine how often it attempts to reconnect to the sensor.
5. Enter the credentials of the occupancy sensor in the **Username** and **Password** fields.

To remove an Ethernet occupancy sensor:

1. Click the check box in the leftmost column to select the occupancy sensor.
2. Click the **Remove** button.

The **Digi-In Models** table is used to name the digital input based occupancy sensor connected to the **IN** port of the DM-NAX-XSP. Enter a friendly name for the occupancy sensor in the **Name** text field.

Port Selection

The Port Selection feature allows the device's internal network traffic to be managed and segregated based on traffic type. Internal VLANs are used to segment the device's management and streaming service traffic to a separate Ethernet port from the audio-over-IP streaming traffic. With Port Selection enabled on all DM NAX devices on a network, DM NAX and AES67 network traffic can be physically separated from the control network onto a dedicated audio network.

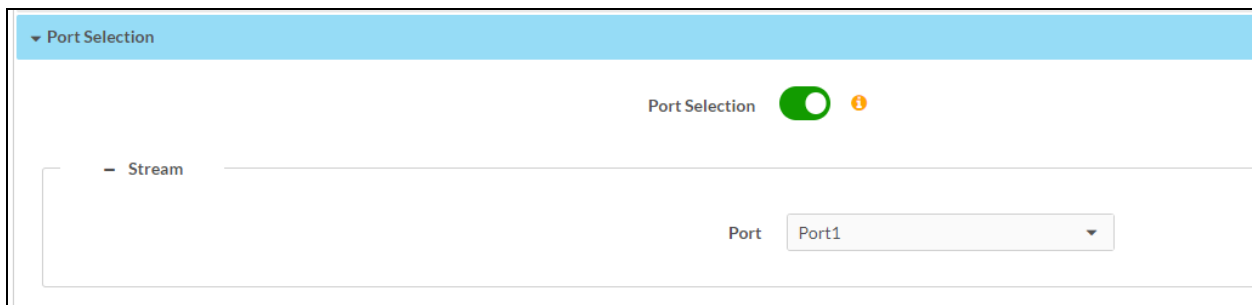

To configure Port Selection:

1. Set the **Port Selection** toggle to the right position to enable Port Selection. Set the toggle to the left position to disable Port Selection. By default, **Port Selection** is disabled.

NOTE: Ports 1 and 2 correspond to the Ethernet adapters labeled **1** and **2** on the rear panel of the DM-NAX-XSP, respectively.

2. With **Port Selection** enabled, select an Ethernet port from the **Stream** drop-down menu to designate which Ethernet port will handle audio-over-IP streaming network traffic.
3. Click **Save** changes to apply the new settings.

NOTE: Making changes to **Port Selection** settings will require a reboot.

Input / Output Selection

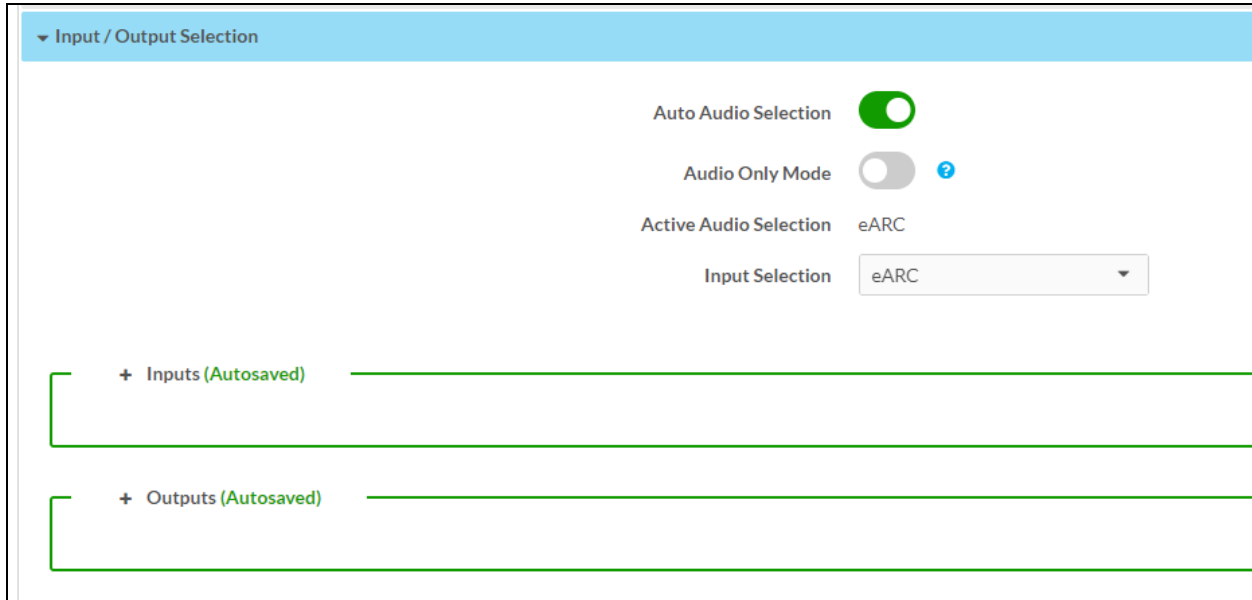

The **Auto Audio Selection** setting determines whether the active audio input of the DM-NAX-XSP is driven automatically by signal detection, or driven manually by either the **Input Selection** drop-down menu or programming.

- Set the **Auto Audio Selection** toggle to the right to enable Auto Audio Selection. Set the toggle to the left to disable Auto Audio Selection. Auto Audio Selection is enabled by default.

Audio Only Mode allows the DM-NAX-XSP to be used exclusively as an audio encoder without requiring an active video signal on the HDMI input. With Audio Only Mode enabled, the HDMI output can maintain A/V sync with the connected display and continue to receive (e)ARC audio without passing video content.

- Set the **Audio Only Mode** toggle to the right to enable Audio Only Mode. Set the toggle to the left to disable Audio Only Mode. Audio Only Mode is disabled by default.

Active Audio Selection is a read only field that indicates which of the audio inputs of the DM-NAX-XSP is currently selected and transmitting audio via the DM NAX and BTS Audio-over-IP (AoIP) streams.

The **Input Selection** drop-down is used to manually select an active audio source for the DM-NAX-XSP to transmit via the DM NAX and BTS AoIP streams. If **Auto Audio Selection** is enabled, this setting will override it and will set a new **Active Audio Selection**. The available options for **Input Selection** are **None**, **HDMI**, **eARC**, **AES67**, and **BTS**.

Surround Sound Audio

The DM-NAX-XSP supports lossless transport of surround sound audio signals (including Dolby® TrueHD, Dolby Atmos®, DTS HD®, and DTS:X® audio signals) and up to 8 channels of uncompressed linear PCM. The DM-NAX-XSP can receive both multichannel and 2-channel downmix signals from another DM-NAX-XSP, allowing either signal to be selected at the HDMI output. The EDID selected at the HDMI output and the EDID of the HDMI sink device will determine which surround sound audio

formats can be sent to the sink device. To configure surround sound audio, set a compatible EDID using the **Manage EDIDs** function from the **Action** menu.

The DM-NAX-XSP can also receive an incoming multichannel surround sound audio signal from the local HDMI input or the eARC path of the HDMI output. Surround sound audio from the local HDMI connections can then be transmitted over the network to another DM-NAX-XSP via the **BTS** stream, or downmixed to stereo and transmitted to any other DM NAX device via the **AES67** stream. The DM-NAX-XSP can distribute both the **BTS** and **AES67** streams simultaneously over the network, allowing either signal to be selected at any receiver on the network.

Inputs

The **Inputs** subsection provides a table of the available inputs on the DM-NAX-XSP, with settings to rename or edit the inputs.

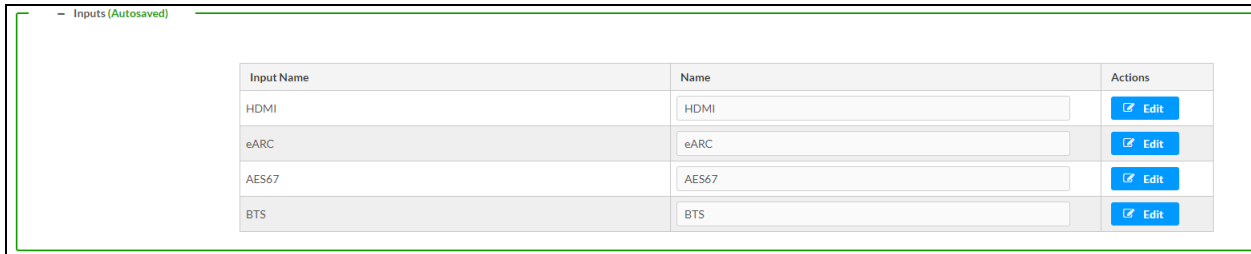

| Input Name | Name | Actions |
|------------|------------------------------------|----------------------|
| HDMI | <input type="text" value="HDMI"/> | Edit |
| eARC | <input type="text" value="eARC"/> | Edit |
| AES67 | <input type="text" value="AES67"/> | Edit |
| BTS | <input type="text" value="BTS"/> | Edit |

Enter a friendly name for each input in the **Name** text fields.

To view the status and available settings for an input, click the **Edit** button in its table row.

DM-NAX-XSP-C442683F3E49 > Inputs
HDMI

✓ Status ⚙ Settings

▼ Input Signal

| | |
|---------------|--------------|
| Sync Detected | Yes |
| Resolution | 1920x1080@60 |
| Source HDCP | Inactive |

— More Details

| | |
|----------------------------|-----------------------|
| Source Content Stream Type | Type 0 Content Stream |
| HDCP State | NotRequired |
| Interlaced | No |
| Horizontal Resolution | 1920 |
| Vertical Resolution | 1080 |
| Frames Per Second | 60 |
| Aspect Ratio | 16:9 |
| Audio Format | PCM |
| Audio Channels | 2 |

All four inputs have a read only **Status** tab that shows video and audio information for the connected source. Video status fields are only populated for the HDMI and eARC inputs, and will show **N/A** for the AES67 and BTS inputs.

The HDMI input has an additional **Settings** tab that includes settings for HDCP capabilities and applying an EDID.

DM-NAX-XSP-C442683F3E49 > Inputs
HDMI

▼ Status Settings

▼ General

Name

HDCP Receiver Capability

▼ EDID

Select

To configure the settings of the HDMI input:

- Enter a friendly name for the HDMI input in the **Name** text field. This will track with the **Name** field from the previous page.
- Use the **HDCP Receiver Capability** drop-down in the **General** section to determine which HDCP keys the HDMI input of the DM-NAX-XSP will present to its source device.
 - With **Auto** selected, the DM-NAX-XSP will attempt to match the HDCP requirements between the connected source and sink devices.
 - With **Disabled** selected, the DM-NAX-XSP will not pass any HDCP protected content to the HDMI output.
 - With **HDCP 1.4** selected, the DM-NAX-XSP will not pass any content protected by an HDCP version higher than 1.4.
 - With **HDCP 2.x** selected, the DM-NAX-XSP will pass all content protected by the latest HDCP 2.x version supported in firmware.
- Use the Select drop-down in the **EDID** section to set an EDID at the HDMI input of the DM-NAX-XSP. To add a custom EDID to this drop-down list, refer to the [Action Menu](#).

Outputs

The **Outputs** subsection provides a table of the available outputs on the DM-NAX-XSP, with settings to rename or edit the outputs.

NOTE: Only the HDMI output has an **Edit** option.

| Output Name | Name | Actions |
|-------------|------------------------------------|----------------------|
| HDMI | <input type="text" value="HDMI"/> | Edit |
| BTS | <input type="text" value="BTS"/> | |
| AES67 | <input type="text" value="AES67"/> | |

Enter a friendly name for each output in the **Name** text fields.

To access the settings of the HDMI output, click the **Edit** button.

DM-NAX-XSP-C442683F3E49 > Outputs
HDMI

Settings

Output

HDMI Output Setting (Autosaved)

Name

Disable Output

Blank Video

HDCP Transmitter Mode

Connected Display

Sink Connected Yes

Manufacturer GSM

Serial Number 1010101

[Save CEDID](#)

To configure the settings of the HDMI output:

- Enter a friendly name for the output in the **Name** text field. This will track with the **Name** field from the previous page.
- Set the **Disable Output** toggle to the right to disable any video signal from passing to the HDMI output. Set the toggle to the left to pass video signal.
- Set the **Blank Video** toggle to the right to send a black screen to the HDMI output instead of passing the HDMI input signal through. Set the toggle to the left to revert to the HDMI input signal.

- Use the **HDCP Transmitter Mode** drop-down to determine which HDCP level will be present on the HDMI output of the DM-NAX-XSP.
 - With **Follow Input** selected, the HDMI output signal HDCP level will be the same as the HDMI input signal from the source device.
 - With **Force Highest** selected, the HDMI output signal HDCP level will be set to the highest version supported in firmware. If this level is not supported by the connected display or the HDMI source, the video output will be blanked.
 - With **Never Authenticate** selected, the HDMI output signal will not authenticate HDCP. Any HDCP content from the HDMI input will be blanked.
- The **Connected Display** subsection reads out the connection status, manufacturer, and serial number of the connected display. Click the **Save CEDID** button to save the EDID of the connected display as a .cedid file. This file can be loaded to the DM-NAX-XSP or other Crestron A/V device.

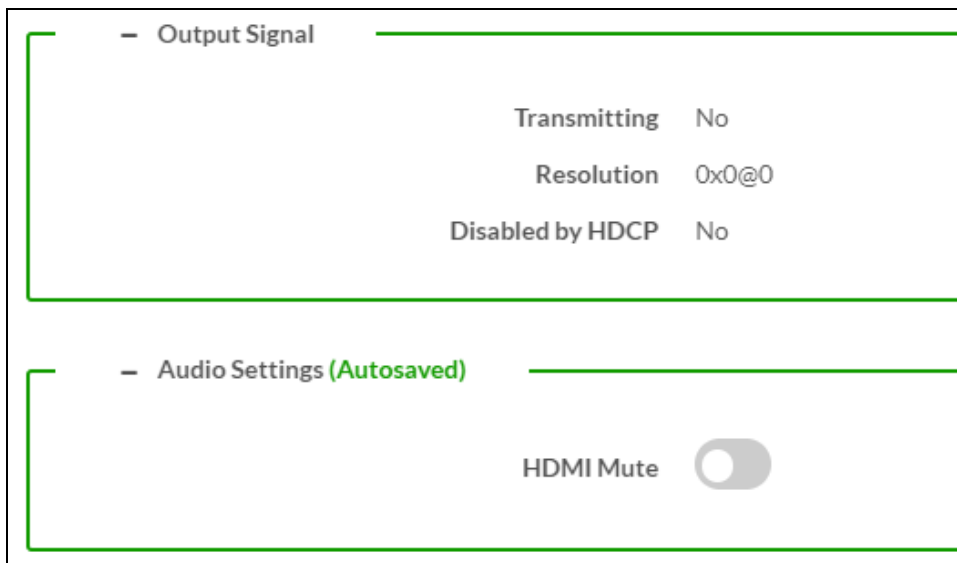

- The **Output Signal** subsection contains read only fields for the transmission, resolution, and HDCP status of the HDMI output.
- The **Audio Settings** subsection contains a toggle to mute the audio of the HDMI output. Set the **HDMI Mute** toggle to the right to mute the audio on the HDMI output. Set the toggle to the left to unmute the output.

Automatic Display Power (Autosaved)

Automatic Power

Automatic Power Trigger Sync

Relay Control None

Selected Relays Relay1 & Relay2

Command Interface CEC

Command Format Hex

Command Terminator None

Output Timeout 5 Seconds

Power Off

Command Power Off: RCP and SS

Test

Power On

Command Power On: RCP and IVO

Test

InputControl

- The Automatic Display Power subsection contains settings for powering the connected display on or off via either CEC, RS-232, IR, or IP. The settings below **Automatic Power** only appear if its toggle is enabled. Set the toggle to the right to enable it, and to the left to disable it. **Automatic Power** is enabled by default.
 - Select any desired triggers for the power commands to be issued from the **Automatic Power Trigger** drop-down. Any number of the three options - **Sync**, **Occupancy**, and **Schedule** - can be selected.
 - The **Relay Control** and **Selected Relays** drop-downs allow the **RELAY** connectors of the DM-NAX-XSP to trigger additional connected devices when the automatic power command is sent to the display. Select the desired **Relay Control** type from either **Latched/Interlocked** or **Momentary**, depending on the control requirements of the connected device.
 - Use the **Command Interface** drop-down to determine whether the power command is issued via CEC, the **RS-232** connector, the **IR** connector, or via a driver that was loaded to the device. See the [Action Menu](#) for more details on loading drivers.
 - If CEC or RS-232 is selected as the command interface, use the **Command Format** drop-down to choose whether the power command is sent as an **ASCII** or **Hex** command. Use the **Command Terminator** drop-down to select any necessary character string to be appended to the end of the power command.
 - If IR is selected as the command interface, use the **IR Settings** subsection to load an IR file specific to the connected display. IR files can be downloaded from the [Crestron Driver Web Portal](#), or created using the Device Learner utility in Crestron Toolbox™ software.
 - Set an **Output Timeout** using the text field or up and down arrows. This determines when the power off command will be sent to the display.
 - Use the **Power Off** and **Power On** subsections to test the power commands.
 - Set the **InputControl** toggle to the right to allow input selection commands to be sent to the connected display. Additional input selection commands can be added or selected in the settings fields that are shown when the toggle is enabled. If CEC or RS-232 is selected as the command interface, the additional input selection commands can be added as text strings in the **Command String** field. If IR is selected as the command interface, the additional commands can be selected from the **Command** drop-down based on any commands included in the IR file.

DM NAX Streams

The local audio sources of the DM-NAX-XSP can be made available as a DM NAX audio-over-IP stream. This includes the HDMI input audio from a local source and the eARC audio from the HDMI output path to the connected display.

Click **NAX Streams** to expand the tab and display the following information.

DM NAX Streams

Device is Master PTP Clock Source **No**

Master Clock Address 00:10:7f:9c:1fa9

PTP Priority 254

- Transmitters (Autosaved)

| Audio Source | Stream Type | Stream | Nax Stream Address | Nax Stream Name | Status | Actions |
|--------------|-------------|----------|--------------------|--------------------------|----------------|---------|
| BTS | BTS | Stream01 | 0.0.0.0 | Stream01c4.42.68.3f3e.49 | Stream Stopped | ▶ ■ ⚙ |
| AES67 | AES67 | Stream02 | 0.0.0.0 | Stream02c4.42.68.3f3e.49 | Stream Stopped | ▶ ■ ⚙ |

- Receivers (Autosaved)

| Audio Source | Stream Type | Stream | Current Stream Address | Requested Stream Address | Status | Actions |
|--------------|-------------|----------|------------------------|--------------------------|----------------|---------|
| BTS | BTS | Stream01 | 0.0.0.0 | 0.0.0.0 | Stream Stopped | ▶ ■ ⚙ |
| AES67 | AES67 | Stream02 | 0.0.0.0 | 0.0.0.0 | Stream Stopped | ▶ ■ ⚙ |

- **Device is Leader PTP Clock Source** indicates whether the DM NAX device's PTP clock is the leader clock on the network. **Yes** will be displayed in green when the local DM-NAX-XSP's clock is the PTP leader clock and **No** will be displayed in red when another PTP clock on the network is operating as the leader clock.
- **Leader Clock Status** displays the Leader Clock ID of the device on the network that is currently acting as the leader clock.
- **PTP Priority:** This sets the priority of the local DM NAX device's PTP clock relative to other clocks on the network. The default setting is 254 (one increment higher than the lowest possible value) so that the DM-NAX-XSP only operates as the leader clock if no other PTP leader is present on the network. Valid values range from 1 to 255.

Configure Transmitters

The DM-NAX-XSP features two main AoIP transmit streams. The first stream listed in the Transmitters list is the **BTS** stream, which is a unique AoIP transmit stream to the DM-NAX-XSP. The **BTS** stream will allow lossless transmission of surround sound audio formats over the network to another DM-NAX-XSP. The second stream is labeled **AES67**, and is a 2-channel AoIP stream that is compatible with all existing DM NAX and DM NVX devices.

To configure a DM NAX transmit stream:

1. Enter a valid multicast address in the **NAX Stream Address** field.
2. Enter a name in the **NAX Stream Name** field by which the stream can be identified. This stream name is associated with the DM NAX stream's multicast address by other DM NAX or AES67 devices, similar to a device hostname that resolves to a given IP address.
3. **Status** indicates whether a stream is transmitting or not. When the stream has started or stopped, the **Status** column will update accordingly.
4. Click the configure button (⚙) in the **Actions** column. The **Configure** dialog appears:

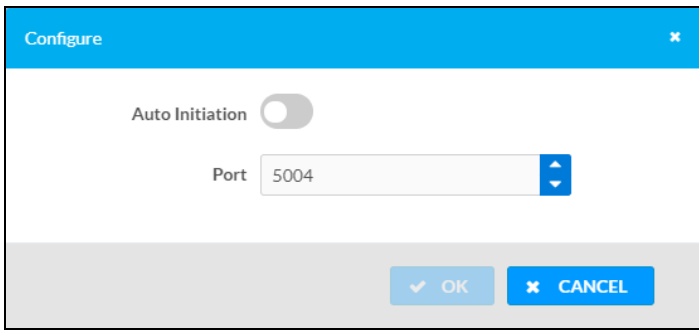

5. Set the **Auto Initiation** toggle to the right position to enable auto initiation. Set the toggle to the left position to disable auto initiation.
 - If **Auto Initiation** is enabled for a given stream, the stream will begin transmitting automatically and will be available as a multicast stream on your network at the specified multicast address.
 - If **Auto Initiation** is disabled for the input, the stream will not begin transmitting until it is manually initiated.
6. To set the port number, do one of the following:
 - Click the arrows to increase or decrease the port number in increments of 1.
 - Manually enter a port number in the **Port** field. The default port number for DM NAX streams is 5004.
7. Click **OK** to save or click **Cancel** to cancel the changes.

Configure Receivers

1. Enter the multicast address of a transmitting stream in the **Requested Stream Address** field to subscribe the receiver to the stream.
2. Click the configure button (⚙️) in the **Actions** column. The **Configure** dialog appears:

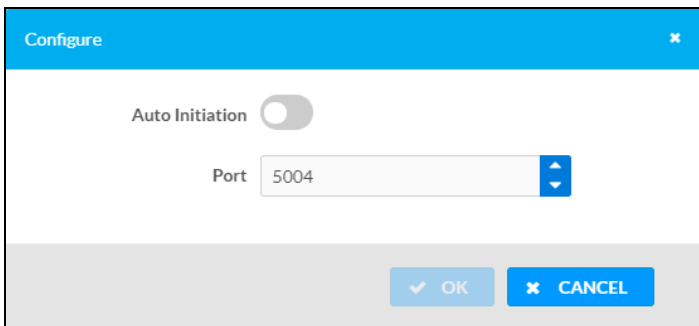

3. Set the **Auto Initiation** toggle to the right position to enable auto initiation. Set the toggle to the left position to disable auto initiation.
 - If **Auto Initiation** is enabled, the stream will begin automatically when the receiver subscribes to the transmitter.
 - If **Auto Initiation** is disabled, the stream will not begin until it is manually initiated.

4. To set the port number, do one of the following:
 - Click the arrows to increase or decrease the port number in increments of 1.
 - Manually enter a port number in the **Port** field. The default port number is 5004.
5. Click **OK** to save or click **Cancel** to cancel the changes.

Security

Click the **Security** tab to configure security for users and groups and to allow different levels of access to the DM-NAX-XSP functions. By default, security is disabled.

The screenshot shows the Security configuration page. At the top, there is a navigation bar with tabs for Status, Settings, Security, and 802.1x Configuration. The Security tab is active. Below the navigation bar, there is a 'Security' section with a dropdown menu set to 'Encrypt'. Underneath, there is an 'SSL Authentication' section with three input fields: 'Username *' containing 'chdevice', 'Password *' containing '****', and 'Confirm Password *' containing '****'. Below this, there are three tabs: 'Current User', 'Users', and 'Groups'. The 'Current User' tab is selected, showing a table with the following information:

| | |
|-----------------------|----------------|
| Name | admin |
| Access Level | Administrator |
| Active Directory User | No |
| Groups | Administrators |

At the bottom left of the 'Current User' section, there is a blue button labeled 'Change Current User Password'.

Select **Encrypt and Validate**, **Encrypt**, or **OFF** in the **SSL Mode** drop-down menu, to specify whether to use encryption. By default, SSL Mode is set to **OFF**.

Current User

Click the **Current User** tab to view read-only information or to change the password for the current user.

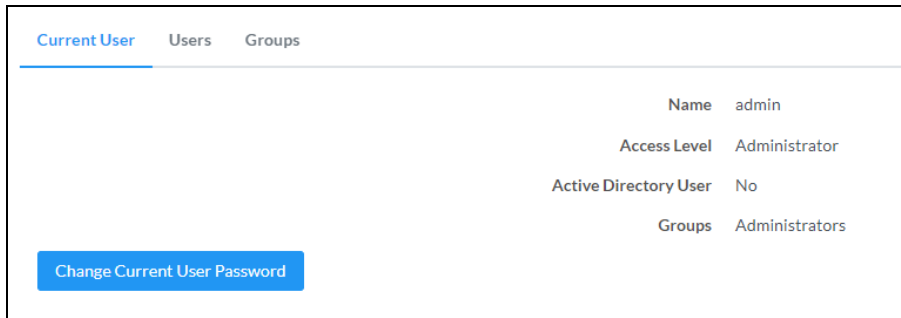

1. Click the **Change Current User Password** button to provide a new password for the current user.
2. In the **Change Password** dialog, enter the current password in the **Current Password** field, the new password in the **Password** field, and then re-enter the same new password in the **Confirm Password** field.

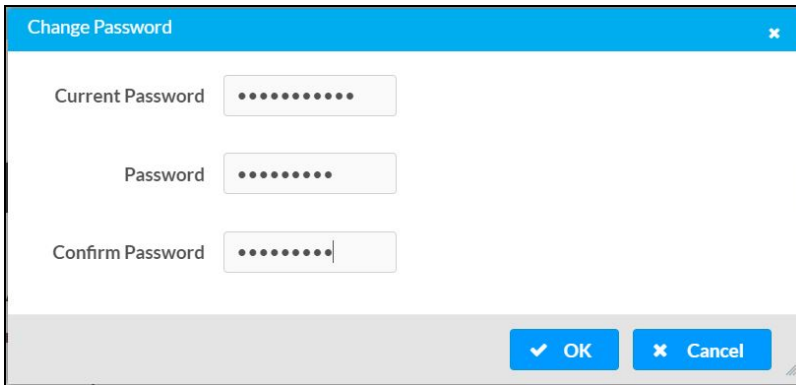

3. Click **OK** to save or click **Cancel** to cancel the changes.

Users

Click the **Users** tab to view and edit user settings. The **Users** tab can be used to add or remove local and Active Directory users and preview information about users.

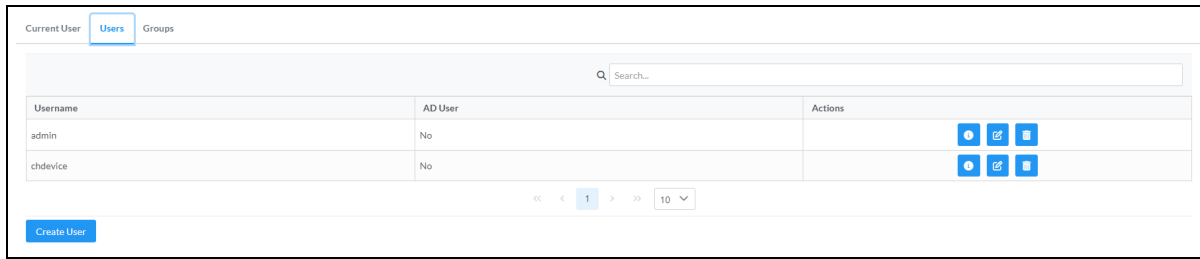

Use the **Search Users** field to enter search term(s) and display users that match the search criteria.

If users listed in the **Users** table span across multiple pages, navigate through the list of users by clicking a page number or by using the left or right arrows at the bottom of the **Users** pane to move forward or backward through the pages.

Each page can be set to display 5, 10, or 20 users by using the drop-down menu to the right of the navigation arrows.

Information about existing users is displayed in table format and the following details are provided for each user.

- **Username:** Displays the name of the user.
- **AD User:** Displays whether the user requires authentication using Active Directory.
Click the corresponding button in the Actions column to view detailed user information or to delete the user.

To create a new user, click the **Create User** button.

Create a New Local User

1. Click the **Create User** button in the User tab.
2. In the **Create User** dialog, enter the following:

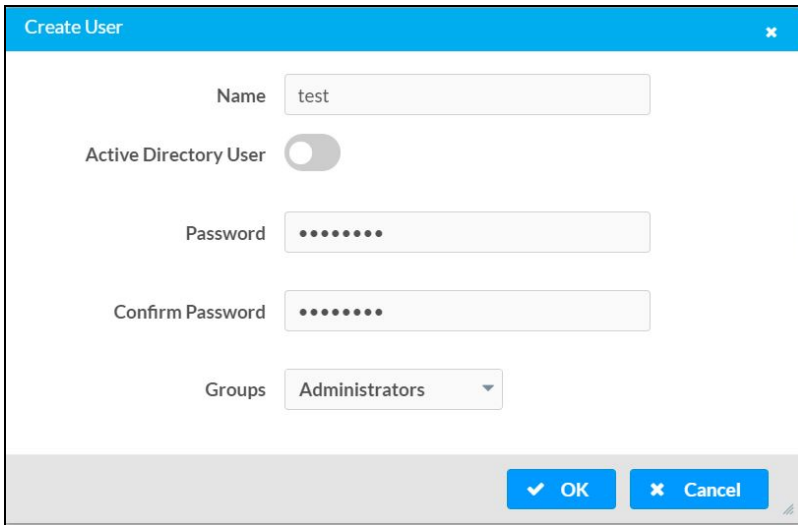

The screenshot shows a 'Create User' dialog box with the following fields and values:

- Name:** test
- Active Directory User:** Disabled (toggle switch is off)
- Password:** Masked with dots
- Confirm Password:** Masked with dots
- Groups:** Administrators (selected in a dropdown menu)

Buttons at the bottom right: **OK** and **Cancel**.

- a. Enter a user name in the **Name** field. A valid user name can consist of alphanumeric characters (letters a-z, A-Z, numbers 0-9) and the underscore "_" character.
- b. Enter a password in the **Password** field; re-enter the same password in the **Confirm Password** field.
- c. Assign the access level by selecting one or more groups from the **Groups** drop-down list.

NOTE: Make sure that the **Active Directory User** toggle is disabled.

3. Click **OK** to save or click **Cancel** to cancel the changes.

Add an Active Directory User

Users cannot be created or removed from the Active Directory server, but access can be granted to an existing user in the Active Directory server.

To grant access to an Active Directory user, you can either add the user to a local group on the DM-NAX-XSP, or add the Active Directory group(s) that they are a member of to the DM-NAX-XSP.

To add an Active Directory user.

1. Click the **Create User** button.
2. In the **Create User** dialog, enter the following.

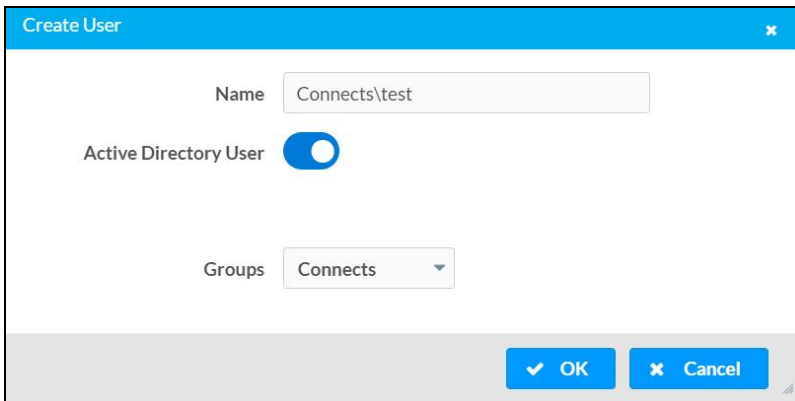

- a. Enter a user name in the **Name** field in the format "Domain\UserName", for example "crestronlabs.com\JohnSmith". Valid user names can contain alphanumeric characters (letters a-z, A-Z, numbers 0-9) and the underscore "_" character.
- b. Select one or more groups from the **Groups** drop-down list.

NOTE: Make sure that the **Active Directory User** toggle is set to enabled.

3. Click **OK** to save or click **Cancel** to cancel the changes.

Delete User

Click the trashcan button () in the **Actions** column to delete the user. Click **Yes** when prompted to delete the user or **No** to cancel the deletion.

After a user is removed from a group, they lose any access rights associated with that group. Note that the user account is not deleted by the delete user operation.

View User Details

Click the information button () in the **Actions** column to view information for the selected user. The **User Details** dialog displays the following information for the selected user.

- **Name:** Displays the name of the selected user.
- **Active Directory User:** Displays whether the user is an Active Directory user.
- **Group:** Displays group(s) the selected user is part of.

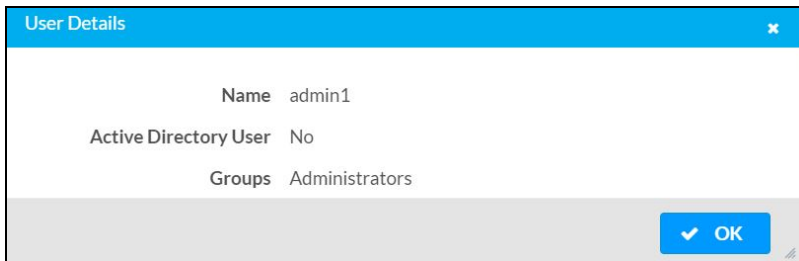

The **User Details** dialog box shows the following information:

| | |
|-----------------------|----------------|
| Name | admin1 |
| Active Directory User | No |
| Groups | Administrators |

At the bottom right, there is a blue button with a checkmark and the text "OK".

Click **OK** to close the **User Details** dialog and to return to the **Users** tab.

Update User Details

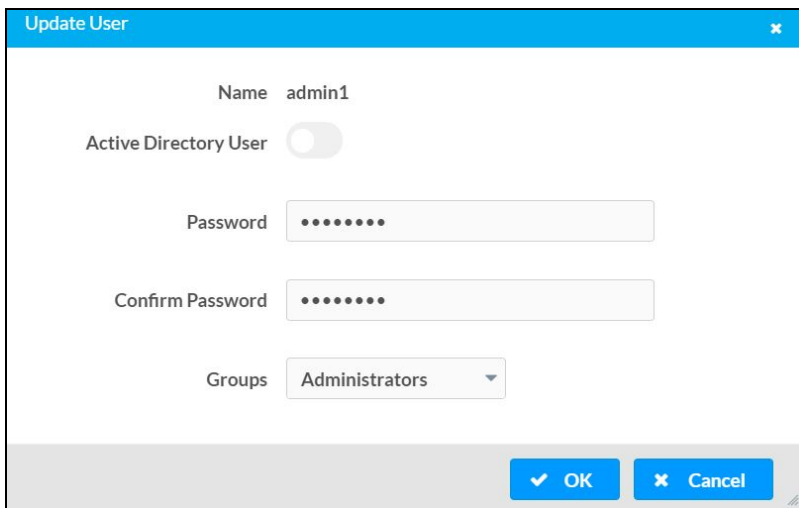

The **Update User** dialog box shows the following information:

| | |
|-----------------------|--|
| Name | admin1 |
| Active Directory User | <input type="checkbox"/> |
| Password | <input type="password" value="....."/> |
| Confirm Password | <input type="password" value="....."/> |
| Groups | Administrators |

At the bottom right, there are two blue buttons: "OK" (with a checkmark) and "Cancel" (with an X).

1. Click the edit button () in the **Actions** column to update information for the selected user.
2. Enter a password in the **Password** field; re-enter the same password in the **Confirm Password** field.
3. Select one or more groups to assign the user to from the **Groups** drop-down list.
4. Click **OK** to save or click **Cancel** to cancel the changes.

The **Update User** dialog also displays the following read-only information for the selected user.

- **Name:** Displays the name of the user.
- **Active Directory User:** Displays whether the user is an Active Directory user.







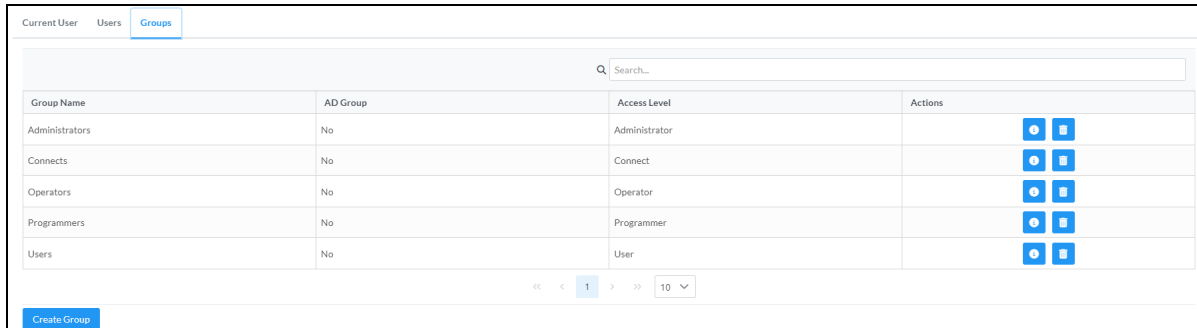



Groups

Click the **Groups** tab to view and edit group settings. The **Groups** tab can be used to add local and Active Directory groups, remove local and Active Directory groups, and preview information about a group.

Use the **Search Groups** field to enter search term(s) and display groups that match the search criteria.



The screenshot shows a web interface with a navigation bar at the top containing 'Current User', 'Users', and 'Groups' (which is highlighted). Below the navigation bar is a search field labeled 'Search...'. The main content area contains a table with the following columns: 'Group Name', 'AD Group', 'Access Level', and 'Actions'. The table lists five groups: Administrators, Connects, Operators, Programmers, and Users. Each group has a corresponding 'AD Group' value (all 'No'), an 'Access Level' (Administrator, Connect, Operator, Programmer, and User respectively), and two action buttons in the 'Actions' column (a blue circle with an 'i' and a blue square with a trash icon). At the bottom of the table, there are navigation arrows and a page number '1'. A 'Create Group' button is located at the bottom left of the interface.



| Group Name | AD Group | Access Level | Actions |
|----------------|----------|---------------|---|
| Administrators | No | Administrator |   |
| Connects | No | Connect |   |
| Operators | No | Operator |   |
| Programmers | No | Programmer |   |
| Users | No | User |   |

If groups listed in the **Groups** table span across multiple pages, navigate through the groups by clicking a page number or by using the left or right arrows at the bottom of the Groups pane to move forward or backward through the pages.

Additionally, each page can be set to display 5, 10, or 20 groups by using the drop-down menu to the right of the navigation arrows.

Existing groups are displayed in a table and the following information is provided for each group:

- **Group Name:** Displays the name of the group.
- **AD Group:** Displays whether the group requires authentication using Active Directory.
- **Access Level:** Displays the predefined access level assigned to the group (Administrator, Programmer, Operator, User, or Connect).

Click the corresponding button in the **Actions** column to view detailed group information () or to delete () selected group.

Click on the **Create Group** button in the **Groups** tab to create new group.

Create Local Group

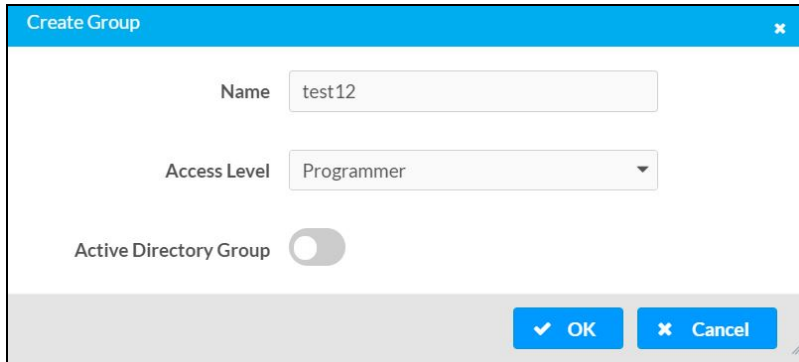

The screenshot shows a 'Create Group' dialog box with the following fields and controls:

- Name:** A text input field containing the value 'test12'.
- Access Level:** A dropdown menu currently showing 'Programmer'.
- Active Directory Group:** A toggle switch that is currently turned off (grey).
- Buttons:** 'OK' and 'Cancel' buttons are located at the bottom right of the dialog.

1. Click the **Create Group** button.
2. In the **Create Group** dialog, enter the following:
 - a. Enter the group name in the **Name** field.
 - b. Assign the group access level by selecting a predefined access level (Administrator, Connect, Operator, Programmer, User) from the **Access Level** drop-down list.

NOTE: Make sure that the **Active Directory Group** toggle is disabled.

3. Click **OK** to save. Click **Cancel** to cancel the changes.

Add Active Directory Group

A group cannot be created or removed from the Active Directory server, but access can be granted to an existing group in Active Directory.

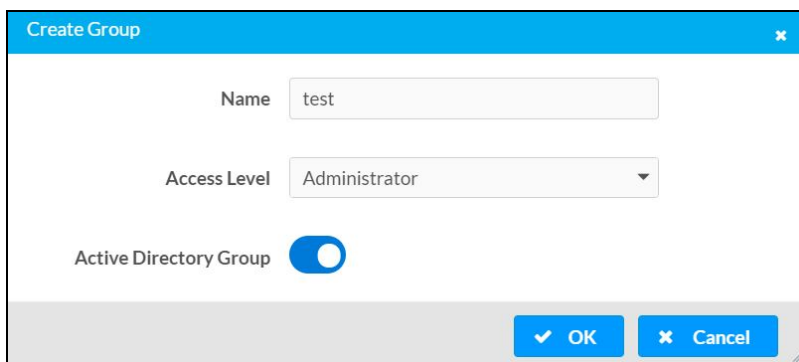

The screenshot shows a 'Create Group' dialog box with the following fields and controls:

- Name:** A text input field containing the value 'test'.
- Access Level:** A dropdown menu currently showing 'Administrator'.
- Active Directory Group:** A toggle switch that is currently turned on (blue).
- Buttons:** 'OK' and 'Cancel' buttons are located at the bottom right of the dialog.

Once the group is added, all members of that group will have access to the DM-NAX-XSP.

1. Click the **Create Group** button.
2. In the **Create Group** dialog enter the following:
 - a. Enter the group name in the **Name** field, for example "Engineering Group". Note that group names are case sensitive; a space is a valid character that can be used in group names.

3. Assign the group access level by selecting a predefined access level (Administrator, Connect, Operator, Programmer, User) from the **Access Level** drop-down list.

NOTE: Make sure that the **Active Directory Group** toggle is enabled.

4. Click **OK** to save. Click **Cancel** to cancel the changes.

Delete a Group

Click the trashcan button () in the **Actions** column to delete a group. Click **Yes** when prompted to delete the group or **No** to cancel the deletion.

When a group is deleted, users in the group are not removed from the device or Active Directory server. However, because a user's access level is inherited from a group(s), users within the deleted group will lose access rights associated with the group.

View Group Details

Click the information button () in the **Actions** column to view information for the selected group. The **Group Details** dialog lists the following information for the selected group.

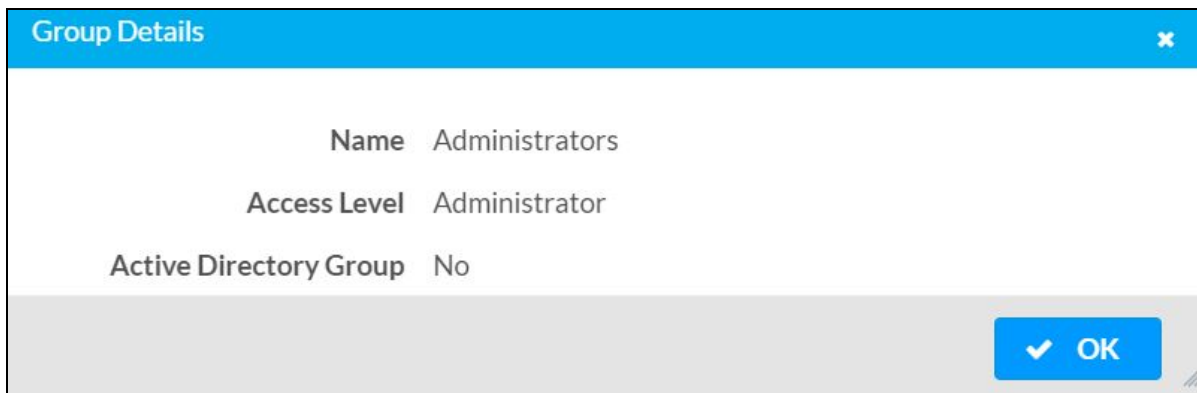

- **Name:** Displays the name of the group.
- **Access Level:** Displays the access level of the group and its users.
- **Active Directory Group:** Displays whether the group is an Active Directory group.

Click **OK** to close the **Group Details** dialog and to return to the Groups tab.

802.1x Configuration

The DM-NAX-XSP has built-in support for the 802.1X standard (an IEEE network standard designed to enhance the security of wireless and Ethernet LANs. The standard relies on the exchange of messages between the device and the network's host, or authentication server), allowing communication with the authentication server and access to protected corporate networks.

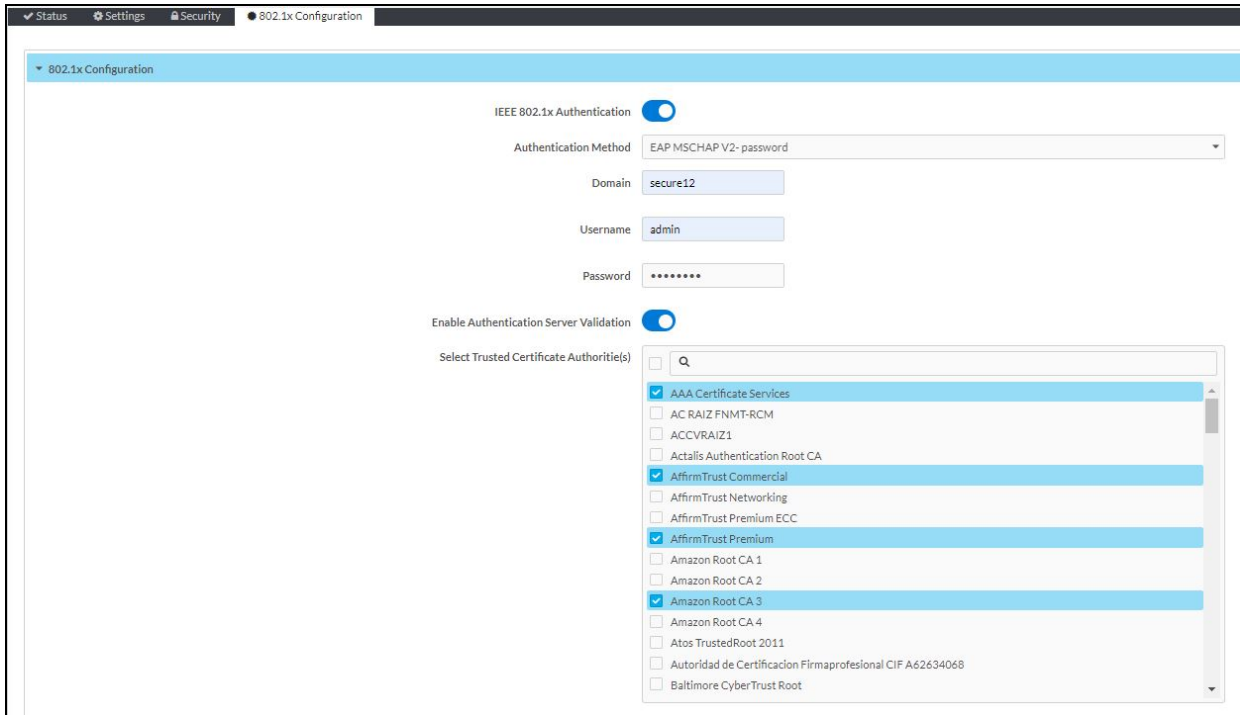

To Configure DM-NAX-XSP for 802.1X Authentication

1. Set the **IEEE 802.1X Authentication** toggle to enabled. This will enable all options on the 802.1X dialog.
2. Select the **Authentication method: EAP-TLS Certificate** or **EAP-MSCHAP V2 Password** according to the network administrator's requirement.
3. Do either one of the following:
 - Select **EAP-TLS Certificate**, click **Action/Manage Certificates** to upload the required machine certificate. The machine certificate is an encrypted file that will be supplied by the network administrator, along with the certificate password.
 - Select **EAP-MSCHAP V2 Password**, enter the username and password supplied by the network administrator into the **Username** and **Password** fields. This method does not require the use of a machine certificate, only the user name and password credentials.
4. If you enabled the **Enable Authentication Server Validation** option, this will enable the **Select Trusted Certificate Authority(ies)** list box which contains signed Trusted Certificate Authorities (CAs) preloaded into the DM-NAX-XSP.

Select the check box next to each CA whose certificate can be used for server validation, as specified by the network administrator.

If the network does not use any of the listed certificates, the network administrator must provide a certificate, which must be uploaded manually via the **Manage Certificates** functionality.

5. If required, type the domain name of the network in the **Domain** field.
6. When the 802.1X settings are configured as desired, click **Save Changes** to save the changes to the device and reboot it. Click **Revert** to cancel any changes.

Access the Web Interface With the Crestron Toolbox™ Application

To access the web interface by opening a web browser within the Crestron Toolbox™ application, do the following:

1. Open the Crestron Toolbox application.
2. From the **Tools** menu, select **Device Discovery Tool**. You can also access the Device Discovery Tool by clicking the Device Discovery Tool button () in the Crestron Toolbox toolbar. The DM-NAX-XSP is discovered and listed in the device list on the left side of the screen. The associated host name, IP address, and firmware version are also displayed.

NOTE: If there is security software running on the computer, a security alert might be displayed when the Crestron Toolbox application attempts to connect to the network. Make sure to allow the connection, so that the Device Discovery Tool can be used.

3. In the Device Discovery Tool list, double-click your device.
4. Enter your credentials in the **Authentication Required** dialog that opens, and then click **Log In**.
5. Click the **Web Configuration** button in the Configuration page displayed on the left side of the Device Discovery Tool.

Resources

The following resources are provided for DM-NAX-XSP.

NOTE: You may need to provide your Crestron.com web account credentials when prompted to access some of the following resources.

Crestron Support and Training

- [Crestron True Blue Support](#)
- [Crestron Resource Library](#)
- [Crestron Online Help \(OLH\)](#)
- [Crestron Training Institute \(CTI\) Portal](#)

Programmer and Developer Resources

- help.crestron.com: Provides help files for Crestron programming tools such as SIMPL, SIMPL#, and Crestron Toolbox™ software
- developer.crestron.com: Provides developer documentation for Crestron APIs, SDKs, and other development tools

Product Certificates

To search for product certificates, refer to support.crestron.com/app/certificates.

