



Retail ASHRAE 90.1-2016 Solutions

Design Guide
Crestron Electronics, Inc.

Contents

About ASHRAE 90.1-2016	1
Design Guide Information	1
ASHRAE 90.1-2016 Code Standards	2
Sales Floor	4
Zūm.....	4
GLPAC.....	5
Small Back of House / Storage	6
Zūm.....	6
GLPP.....	7
Public Restroom	8
Zūm.....	8
GLPP.....	9

TOTAL ENERGY CONSUMPTION

Per capita usage; 10⁹ BTU per person

	OIL	COAL	SOLAR
Temperate climates	2.50b	3.1b	0.25
Subtropical climates	1.23b	0.55b	1.18
Hot climates	0.09b	0.19b	3.73
Cold climates	1.15b	1.30b	2.21
	0.20b	0.82b	1.32
	Total: 5.17	Total: 5.96	Total: 8.63



About ASHRAE 90.1-2016

ASHRAE 90.1-2016 is a residential and commercial building energy code that is designed to reduce energy consumption. The goal of this code is to reduce energy consumption by providing design and construction requirements for lighting controls.

Lighting controls such as occupancy status sensors, multi-level controls, and demand response provisions allow you to synchronize indoor light levels with daylight levels in accordance with ASHRAE 90.1-2016.

Design Guide Information

Crestron® offers this Design Guide for Retail - ASHRAE 90.1-2016 solutions to use as a reference for typical layouts. Use it as guidance to make code compliance quick and easy. The Crestron team is also available to support with detailed design, submittal, and installation requirements. For additional information, please contact your Crestron representative at CLCDesign@crestron.com or (888) 330-1502.

ASHRAE 90.1-2016 Code Standards

Summary

ASHRAE 90.1-2016 Code Standards

	Code Provision	Minimum Control Requirement	Code Description
ON/OFF CONTROLS	9.4.1.1	Automatic Full On (Occupancy Sensing Mode)	Lighting is permitted to automatically turn to full on.
	9.4.1.1.a	Local Control	There should be one or more readily accessible manual lighting controls in each space.
	9.4.1.1.b/c	Manual On / Partial Auto On (Vacancy Sensing Mode)	The general lighting can be manually turned on or automatically turned on up to 50%.
	9.4.1.1.g	Automatic Partial Off	Lighting power should be automatically reduced by at least 50% within 20 minutes of vacancy.
	9.4.1.1.h	Automatic Full Off	All lighting must be shut off within 20 minutes of vacancy.
	9.4.1.1.i	Scheduled Shutoff (Programmable Timeclock)	All lighting should be automatically shut off during periods when the space is scheduled to be unoccupied using a programmable timeclock or signal from another control device (i.e. security system).
LIGHT LEVEL CONTROL	9.4.1.1.e/f	Automatic Daylight Control (Photocontrol)	In primary side daylight general lighting zones using more than 150W (or using more than 300W within the primary and secondary daylight zones), daylight must be harvested using photocontrols.
			In top daylight general lighting zones using more than 150W, daylight must be harvested using photocontrols.
			Primary Solutions
			Zūm™ Wireless Light Control
			GLPP
			GLPAC

* Optional

** Sales Areas do not need to comply with 9.4.1.1.e for automatic daylighting (sidelighting).

Space Type		
Sales Floor	Small Back of House / Storage <50 sq. ft.	Restroom
	✓	✓
✓	✓	✓*
✓		
✓	✓	✓
or	or	
✓	✓	
✓**	✓	✓
✓	✓	✓
✓	✓	✓

Sales Floor

Zūm

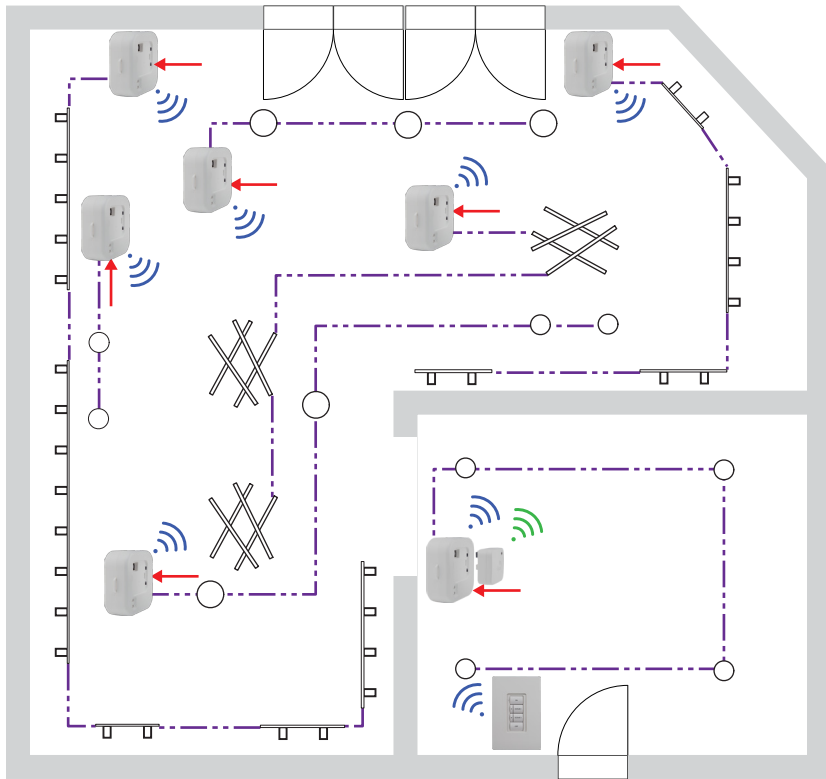

- ▶ Add a ZUM-FLOOR-HUB and ZUMNET-GATEWAY for scheduled shutoff (9.4.1.1.i).
- ▶ Sales areas do not need to comply with automatic daylighting (sidelighting) (9.4.1.1.e).

ASHRAE 90.1-2016 Code Compliance:

- ▶ Local Control (9.4.1.1.a)
- ▶ Manual On / Partial Auto On (Vacancy Sensing Mode) (9.4.1.1.b/c)
- ▶ Automatic Full Off (9.4.1.1.h)

Local Control:



Symbol	Qty.	Product	Description
	7	ZUMMESH-JBOX-5A-LV	Junction Box Zone Controller, 0-10V Dimming, 5A
	1	ZUMMESH-NETBRIDGE	Zūm™ Network Bridge
	1	ZUMMESH-KP10CBATT	6-Button Battery Powered Keypad

Sales Floor

GLPAC

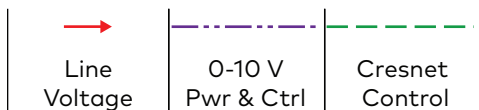
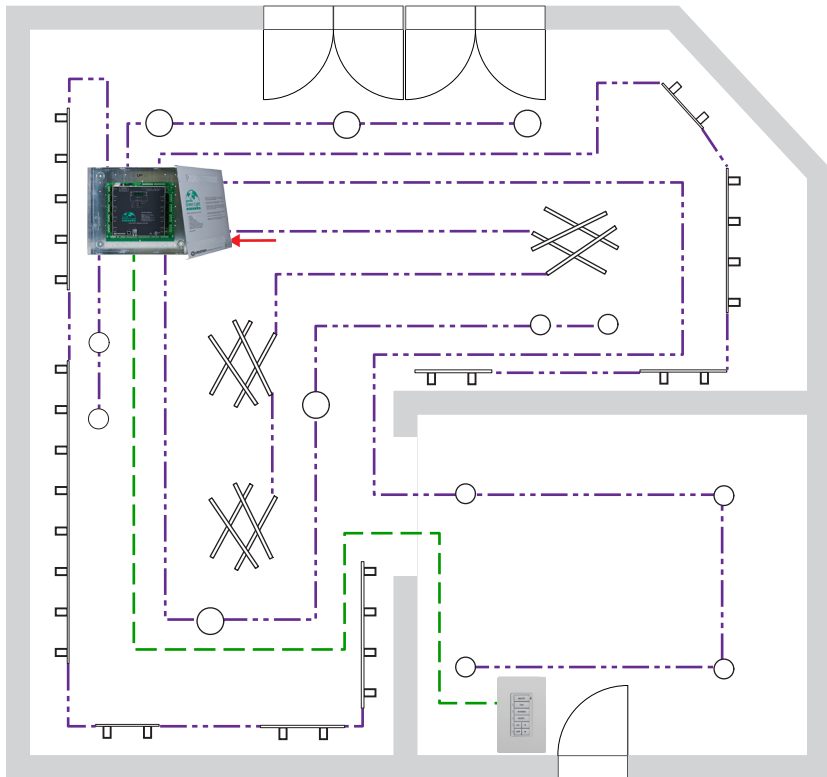



▶ Sales areas do not need to comply with automatic daylighting (sidelighting) (9.4.1.1.e).

ASHRAE 90.1-2016 Code Compliance:

- ▶ Local Control (9.4.1.1.a)
- ▶ Manual On / Partial Auto On (Vacancy Sensing Mode) (9.4.1.1.b/c)
- ▶ Scheduled Shutoff (Programmable Timeclock) (9.4.1.1.i)

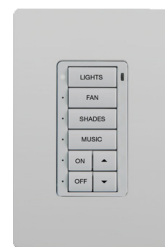
Local Control:



Symbol	Qty.	Product	Description
	1	GLPAC-DIMFLV4	Green Light Integrated Lighting System, 4-Channel
	1	C2N-CBD-P	Cameo® Keypad, Standard Mount

Small Back of House / Storage

Zūm

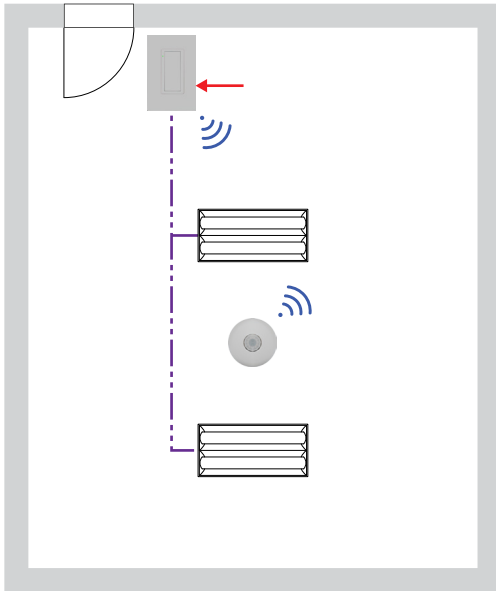

ASHRAE 90.1-2016 Code Compliance:

- ▶ Automatic Full On (Occupancy Sensing Mode) (9.4.1.1)
- ▶ Local Control (9.4.1.1.a)
- ▶ Automatic Full Off (9.4.1.1.h)

Local Control:

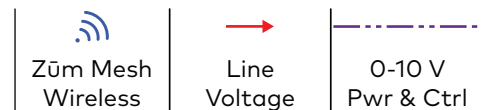
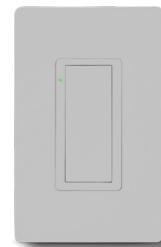

- ▶ Local control (9.4.1.1.a) is optional.

Symbol	Qty.	Product	Description
	1	ZUMMESH-5A-LV	Zūm™ Wall-Box Dimmer, 5A
	1	ZUMMESH-PIR-VACANCY-BATT	PIR Vacancy Sensor (AUTO-OFF)

Small Back of House / Storage

GLPP

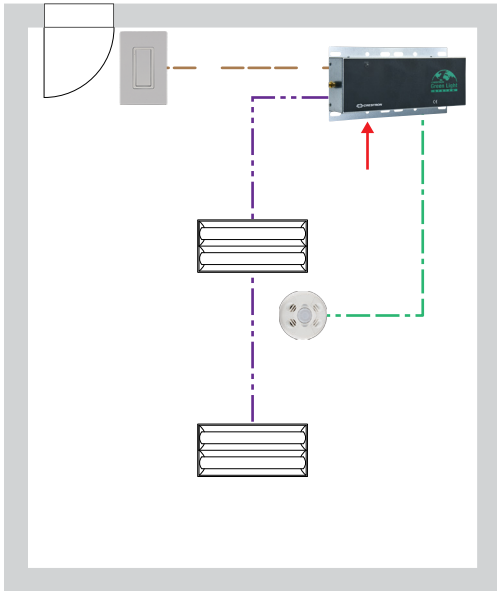

ASHRAE 90.1-2016 Code Compliance:

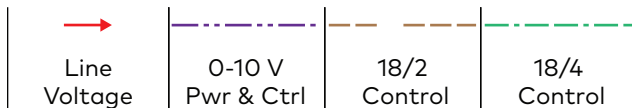

- ▶ Automatic Full On (Occupancy Sensing Mode) (9.4.1.1)
- ▶ Local Control (9.4.1.1.a)
- ▶ Automatic Full Off (9.4.1.1.h)



- ▶ Local control (9.4.1.1.a) is optional.

Local Control:



Symbol	Qty.	Product	Description
	1	GLPP-DIMFLVCN-PM	1-Ch 0-10V Dimmer with Cresnet®
	1	GLPPA-KP	In-Wall Keypad for GLPP
	1	GLS-ODT-C-NS	Dual-Technology Ceiling Mount Occupancy Sensor, 2000 sq. ft.

Public Restroom

Zūm

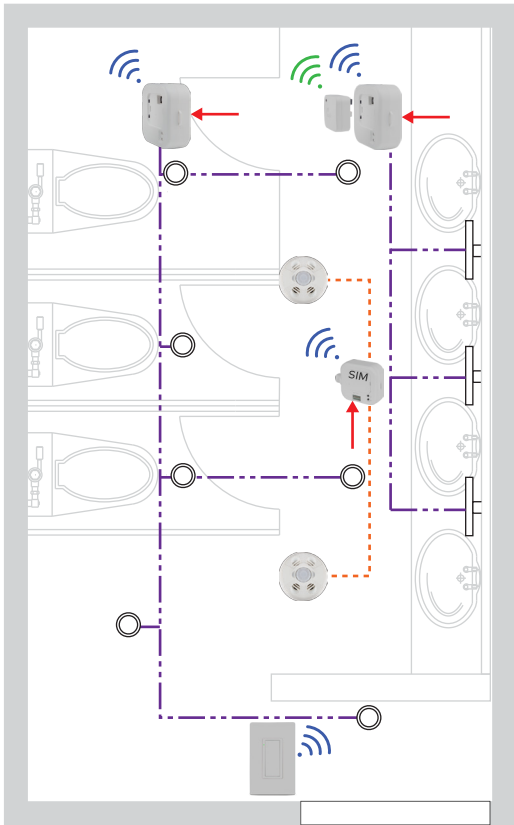

ASHRAE 90.1-2016 Code Compliance:

- ▶ Automatic Full On (Occupancy Sensing Mode) (9.4.1.1)
- ▶ Local Control (9.4.1.1.a)
- ▶ Automatic Full Off (9.4.1.1.h)

Local Control:

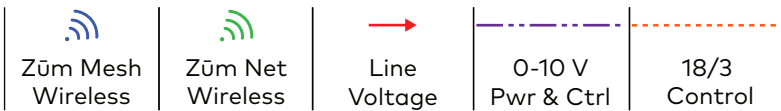
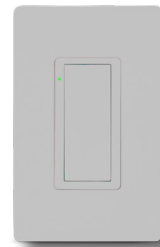

- ▶ Local control (9.4.1.1.a) is optional.
- ▶ Automatic daylight control (photocontrol) (9.4.1.1.e/f) may be required if windows are present.

Symbol	Qty.	Product	Description
	2	ZUMMESH-JBOX-5A-LV	Junction Box Zone Controller, 0-10V Dimming, 5A
	1	ZUMMESH-JBOX-SIM	Zūm™ Junction Box Sensor Integration Module
	1	ZUMMESH-NETBRIDGE	Zūm™ Network Bridge
	1	ZUMMESH-KP10ABATT	Rocker-Switch Battery Powered Keypad
	2	GLS-ODT-C-NS	Dual-Technology Ceiling Mount Occupancy Sensor

Public Restroom

GLPP

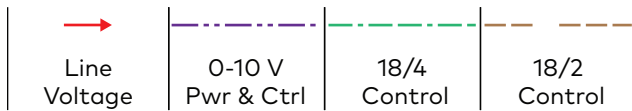
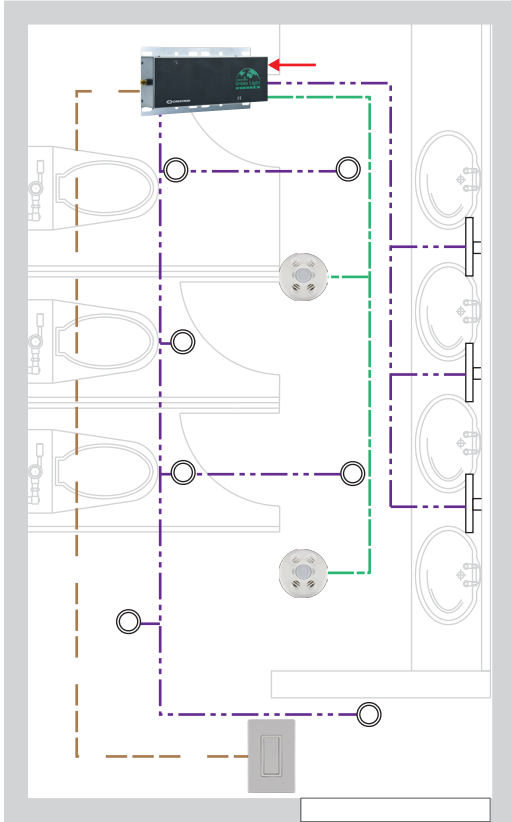



- ▶ Local control (9.4.1.1.a) is optional.
- ▶ Automatic daylight control (photocontrol) (9.4.1.1.e/f) may be required if windows are present.

ASHRAE 90.1-2016 Code Compliance:

- ▶ Automatic Full On (Occupancy Sensing Mode) (9.4.1.1)
- ▶ Local Control (9.4.1.1.a)
- ▶ Automatic Full Off (9.4.1.1.h)

Local Control:



Product	Qty.	Product	Description
	1	GLPP-1DIMFLV2CN-PM	2-Ch 0-10V Dimmer with Cresnet®
	2	GLS-ODT-C-NS	Dual-Technology Ceiling Mount Occupancy Sensor
	1	GLPPA-KP	In-Wall Keypad for GLPP

Notes

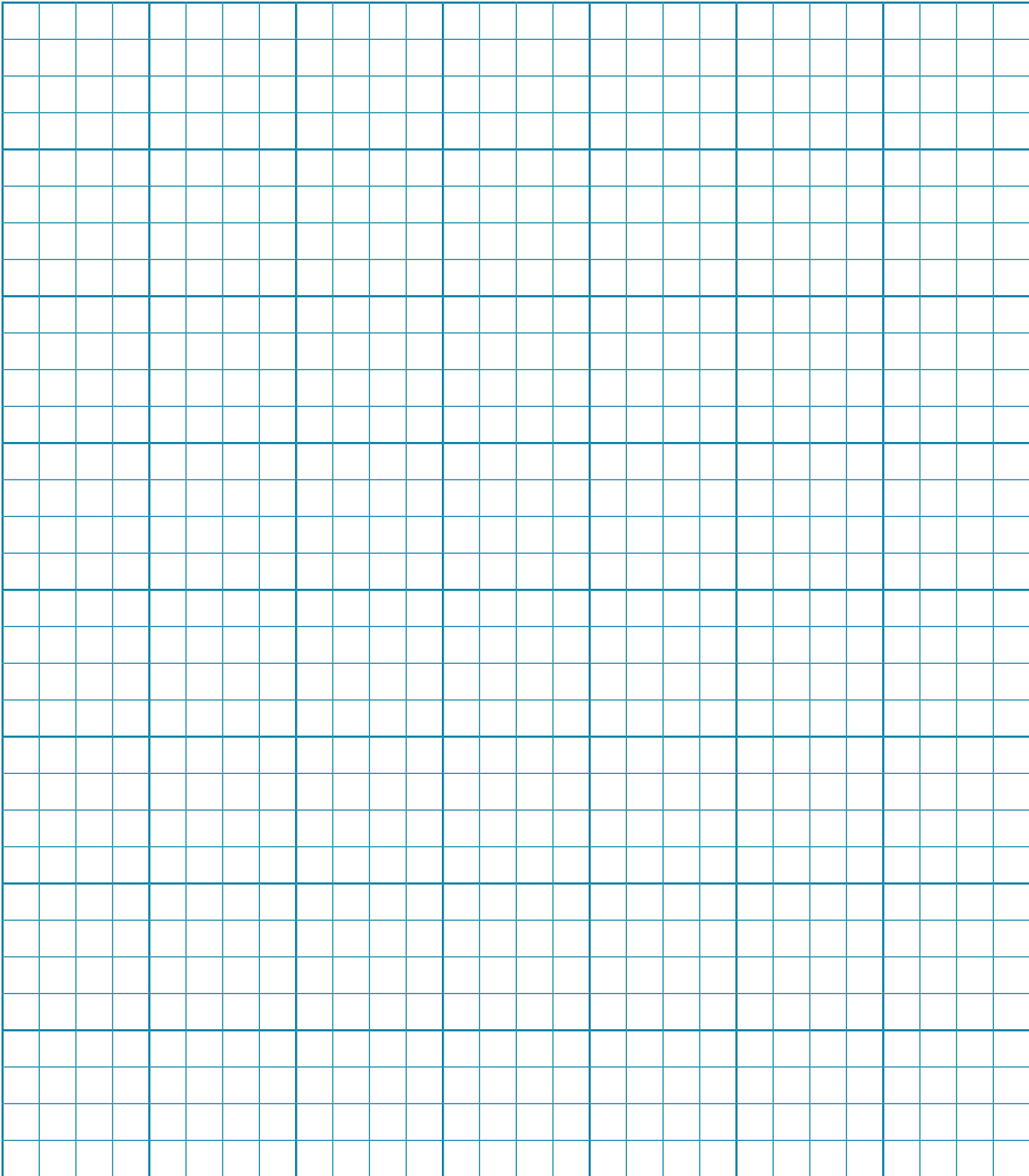

Crestron, the Crestron logo, 3-Series, Cresnet, Crestron Green Light, Cameo, Zūm are either trademarks or registered trademarks of Crestron Electronics, Inc. in the United States and/or other countries. ASHRAE is a trademark or registered trademark of American Society of Heating, Refrigerating and Air-Conditioning Engineers, Inc. in the United States and/or other countries. Other trademarks, registered trademarks, and trade names may be used in this document to refer to either the entities claiming the marks and names or their products. Crestron disclaims any proprietary interest in the marks and names of others. Crestron is not responsible for errors in typography or photography.

This document was written by the Technical Publications department at Crestron Electronics, Inc.

©2018 Crestron Electronics, Inc.

