

GLA-IR-QUATTRO-COM1-24

by Steinel

Presence Detector



The IR Quattro COM1-24 is a low voltage passive infrared presence detector setting a new standard in lighting control with minimal movement required for human presence detection. It features a single pyroelectric detector with a high performance lens system creating 1,760 switching zones. Operational choices of manual on or auto on with either momentary or maintained switch options. Included light level feature provides the option to turn lights off when sufficient daylight is present for additional energy savings. The innovative mechanical reach setting enables the designer with a precise method of controlling lighting zones by means of optimizing the sensors detection reach without compromising sensitivity providing true precise presence detection in the desired detection zone. The convenient "COM-Link" feature enables multiple sensors to link together via the communication link for peer to peer grouping achieving expanded detection zones with convenient control set up functions set at only one primary sensor for the entire group. Mounting options provide for 4" Square box, 4" Octagon box, Round 3.0 Mud-Ring or directly to the ceiling with quick mount spring tabs. The available time saving wireless remote commissioning set up tool and the user / occupant wireless remote provides addition convenience.

The Control PRO group of sensors are available in multiple technologies for the control of heating, ventilation and air conditioning as well as lighting (as in the COM2-24 versions) and optional 1-10 volt dimming and daylighting options (in the DIM-24 versions).

Applications

The typical application is for offices, conference rooms, classrooms and other indoor public building spaces.

Item No.	IR Quattro COM1-24
Accessories	RC 3 service remote RC 4 user remote WGC wire guard cage
Voltage	18 - 24 VDC/VAC (30 mA)
Load Rating	control output - 1 A @ 30 VAC/VDC
Sensing Technology	passive infrared (PIR)
Time Delay Setting	control output 30 sec. - 30 min. pulse mode (approx. 2 sec. 'ON' 8 sec. 'OFF') IQ mode (automatic adjustment to the usage profile)
Light Level Setting	10 - 1000 lux / 1 - 100 fc
Environment	IP20 rated, 0°C to +40°C, 32°F to +104°F
Installation Height	2.5 - 8 m / 8 - 26 ft
Coverage at 9 ft	360° square mechanically scalable detection zones presence: max. 4.7 x 4.7 m (22.09 sq.m.) max. 15 x 15 ft (225 sq.ft.) radially: max. 4.7 x 4.7 m (22.09 sq.m.) max. 15 x 15 ft (225 sq.ft.) tangentially: max. 7.1 x 7.1 m (50.41 sq.m.) max. 23 x 23 ft (529.00 sq.ft.)
Lens Design	13 detection levels, 1760 switching zones
Dimensions	4.72 x 4.72 x 3.03 in, 120 x 120 x 77 mm (LxWxD)
Warranty	5 years
Certifications	C-UL-US Listed, RoHS compliant, UL 2043 Plenum Rated, CA Energy Code compliant

Key Features:

- Low voltage (18-24 VDC/VAC) sensor for use with a power pack or building automation system
- PIR Presence Detection
- Mechanical reach setting
- Square coverage pattern with 1760 switching zones
- Service and user wireless remotes available
- Manual ON mode (MAN) / Automatic mode (AUTO)
- Momentary / Maintained switch option
- 'ON' only / 'ON' & 'OFF' manual switching
- Light level feature turns lights off when sufficient daylight is present
- Mounts to a 4" Square box, 4" Octagon box, Round 3.0 Mud-Ring or directly to the ceiling with quick mount spring tabs
- "COM-Link" communication allows for up to 10 sensors to be grouped together
- IQ Mode dynamically adjusts the 'ON' time delay by learning individual room occupancy

PIR

1760 PIR Detection Zones



15 x 15 Ft Presence
23 x 23 Ft Tangential



1 - 100 fc



18-24 VDC/VAC



30 Sec - 30 Min

GLA-IR-QUATTRO-COM1-24

by Steinel

Presence Detector



Wiring

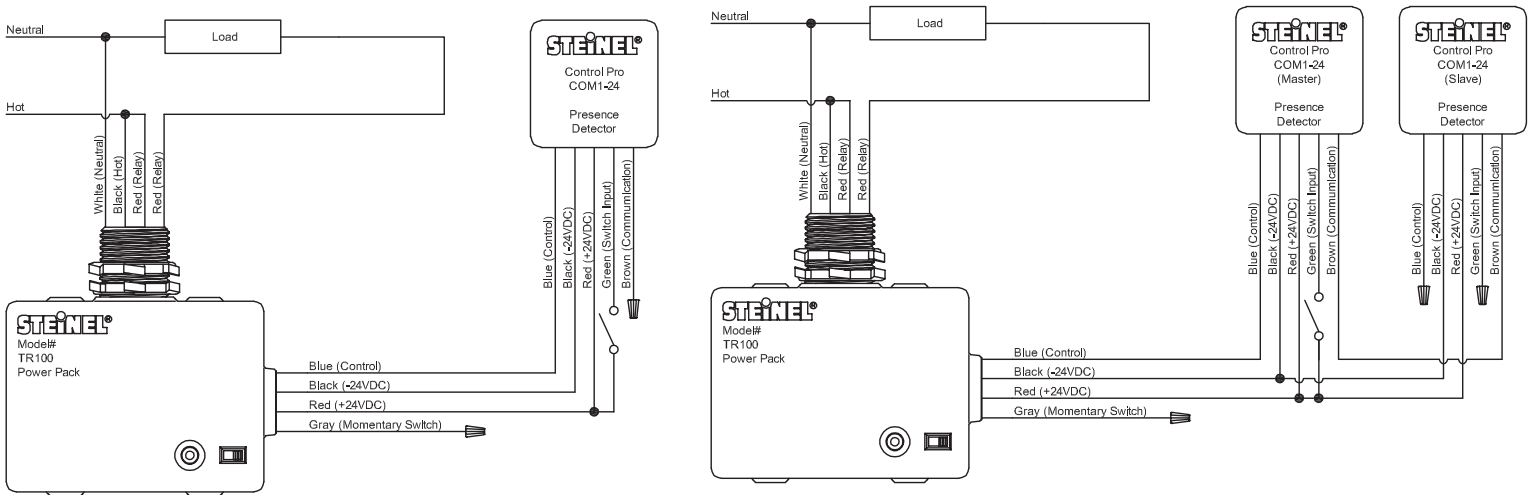

Settings

Mechanical Scalability

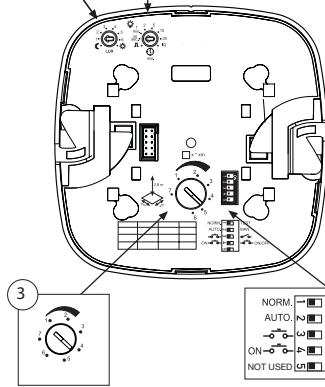
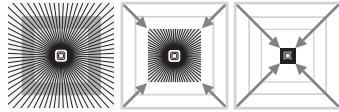
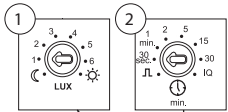

- 1 - Light level setting
- 2 - Occupancy time delay setting
- 3 - Reach setting
- 4 - Sensor DIP switch settings

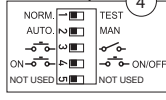

- DIP 1 - Normal mode / Test mode (NORM / TEST)
- DIP 2 - Manual ON mode (MAN) / Automatic mode (AUTO)
- DIP 3 - Momentary / Maintained switch option
- DIP 4 - 'ON' only / 'ON' & 'OFF' manual switching
- DIP 5 - Not used

Coverage

Shown at 9 ft mounting height. Coverage will vary depending on mounting height. See pages 4 & 5 of the instruction manual for coverage at heights from 8 to 13 ft. Maximum mounting height up to 26 ft.

One Gridline = 0.5 m / 1.5 ft

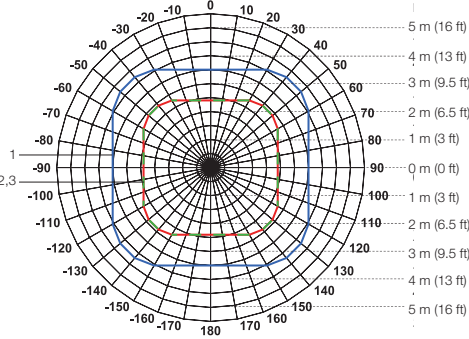

- 1 - Tangential - motion perpendicular to the sensor
7.1 x 7.1 m (23 x 23 ft)
- 2 - Radial - motion either directly toward or away from the sensor
4.7 x 4.7 m (15 x 15 ft)
- 3 - Presence - minor motion as described by NEMA WD7 with the additional requirement of both radial and tangential detection
4.7 x 4.7 m (15 x 15 ft)

Mounting

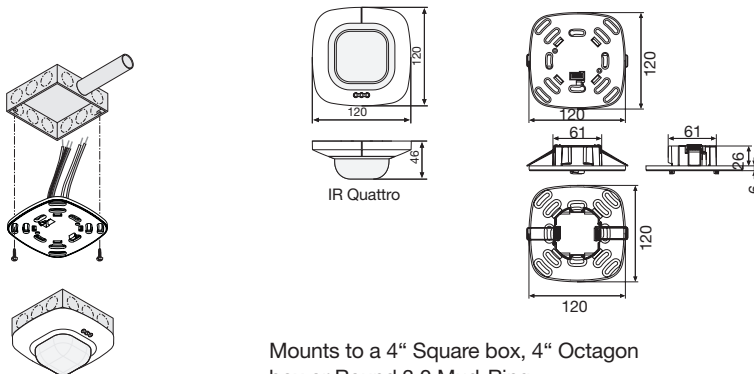

Mounts to a 4" Square box, 4" Octagon box or Round 3.0" Mud-Ring

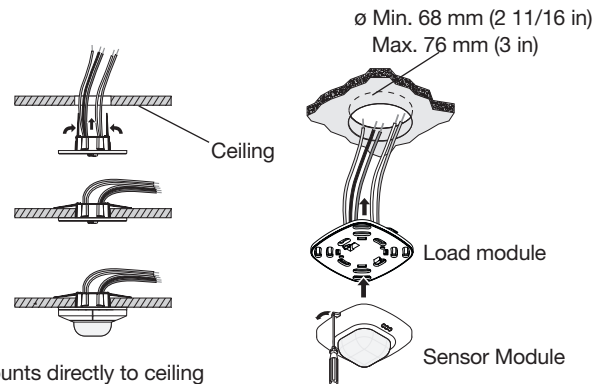

Mounts directly to ceiling with quick mount spring tabs