

Crestron **ML-600**

Mini LCD RF Wireless Handheld Remote

Operations Guide



This document was prepared and written by the Technical Documentation department at:



Crestron Electronics, Inc.

15 Volvo Drive

Rockleigh, NJ 07647

1-888-CRESTRON

All brand names, product names and trademarks are the property of their respective owners.

©2006 Crestron Electronics, Inc

# Contents

<b>Mini LCD RF Handheld Remote: ML-600</b>	<b>1</b>
Introduction .....	1
Features and Functions .....	1
Specifications.....	2
Physical Description .....	2
Miscellaneous .....	8
Using the Backlight .....	8
Installing/Changing the Batteries .....	8
Adjusting the Display Contrast.....	9
Cleaning the Screen .....	9
Problem Solving.....	10
Troubleshooting .....	10
Further Inquiries .....	10
Industry Compliance.....	11



# Mini LCD RF Handheld Remote: ML-600

---

## Introduction

### Features and Functions

The Crestron® Mini LCD RF Handheld Remote (ML-600) is a universal remote control that can be used to control a Crestron system. A liquid-crystal display (LCD) with switchable backlighting provides the user with a listing of available functions and system commands. With a wireless range of up to 200 feet, the ML-600 can be used almost anywhere in a home or facility. The remote is powered by four AAA batteries (included).

#### *Functional Summary*

- Easy-to-use preprogrammed functions for your Crestron system
- 2.1" x 1.4" backlit, LCD screen for function selection
- Ten preprogrammed soft keys which can be used to access custom command sequences, system functions, and preferences
- Storage for 50 preprogrammed "favorite" functions and/or settings
- Up to 200-foot RF wireless range allows system control from almost anywhere in a building
- Intuitive interface for easy operation
- Five directional buttons for navigating on-screen menus found on A/V devices
- Transport controls for controlling a variety of audio and video sources
- Volume and channel controls
- Numeric keypad for entry of numeric data
- Switchable backlighting for viewing display and buttons in a variety of lighting conditions

## Specifications

The following table lists specifications for the ML-600.

### *Specifications for the ML-600*

SPECIFICATION	DETAILS
Battery Power	6.0 VDC (Four AAA Alkaline batteries supplied)
RF Output	418 MHz
RF Range	Up to 200 feet (depending on physical structures and electronic interference)
Buttons	(1) "ON" button (1) "OFF" button (10) "Soft" buttons (3) Menu navigation buttons (32) "Hard" buttons including a numeric keypad, transport controls, and directional controls
LCD Screen	2.10" x 1.40" (5.33 cm x 3.56 cm)
Backlighting	Switchable backlighting for buttons and LCD screen. Automatic shutoff after 15 seconds.
Enclosure	High impact, rubberized plastic enclosure
Operating Temperature and Humidity	50° to 113° F (10° to 45° C), 10 to 90% Relative Humidity (non-condensing)
Dimensions and Weight (with batteries)	Height: 9.05 in (22.99 cm) Width: 3.07 in (7.80 cm) Depth: 1.40 in (3.56 cm) Weight: 0.5 lbs (0.23 kg)

## Physical Description

The ML-600 (refer to the following illustrations) has a 2.10" x 1.40" (5.33 cm x 3.56 cm) LCD screen. The LCD screen lists the options associated with the 10 preprogrammed soft keys that flank the LCD screen. Three navigation keys are used to switch between control screens on the remote control. There are 34 buttons that are used for device-specific functions. A button on the right side of the remote switches the display/keypad backlighting on and off. For information on the operation of the ML-600, refer to "Menu System" on page 5.

*ML-600, Front View*



*Physical Views of the ML-600*

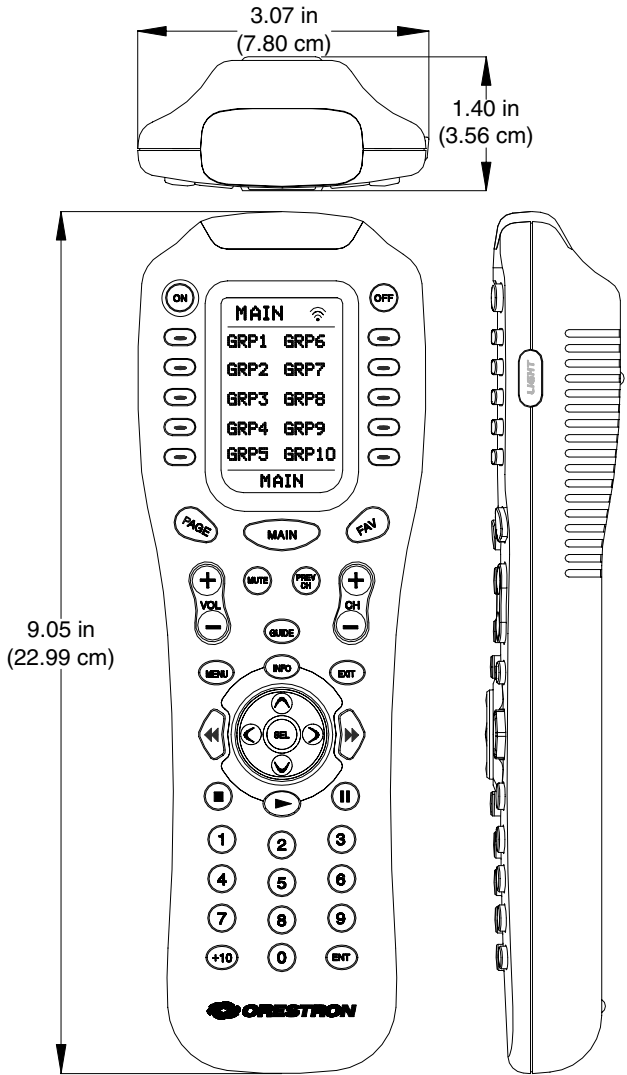



## Menu System

The ML-600 uses a menu to access all of the functions the remote is capable of performing. The menu has a MAIN section that can contain up to two pages. These main pages can list up to 19 groups of options. Depending on your remote’s configuration, each option can be a selection of a room, device, or system function. Each group can contain up to four pages. Each page lists up to 10 additional options.

There is also a “Favorites” section that can contain up to 50 favorite functions or settings that are listed on five pages (up to 10 functions or settings per page).

The following diagram illustrates the structure of ML-600’s menus.

### ML-600 Menu Structure

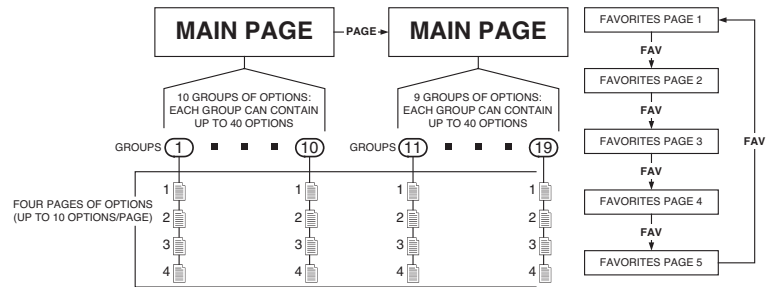

DEPENDENT ON YOUR SYSTEM CONFIGURATION, AN OPTION CAN BE A ROOM SELECTION, DEVICE SELECTION, OR COMMAND

All of the available options are shown on the LCD screen and are selected with the soft keys that flank the LCD. You can scroll through pages in the menu system by using the navigation keys and operate devices in the system with the hard keys. For instructions on using the navigation keys, refer to “Navigation Keys” on page 6.

## LCD Display & Soft Keys

The LCD screen shows the current location within the menu system as well as the options that are assigned to each soft key.

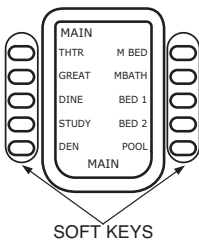

The top line of the screen indicates the name of the page or group while the bottom line shows the page number (if applicable). The illustration to the left shows a sample MAIN page, which is indicated by the word “MAIN” on the top and bottom lines of the screen.

**NOTE:** The MAIN section may contain up to two pages.

Ten soft keys flank the sides of the LCD. A soft key differs from a hard key, as it does not have a fixed function. The assigned option of each soft key is shown on the LCD adjacent to a corresponding soft key. The options listed on the LCD change from page to page. Pressing a soft key will carry out the assigned option.

**NOTE:** The remote control is transmitting to the system when the  indicator is displayed. The remote will not respond to a new button push while it is transmitting.

## Navigation Keys



The three navigation keys located under the LCD are used to view the different pages in the menu system.

### PAGE

After pressing a group's soft key from a MAIN page, press the **PAGE** button to view pages within the selected group. After reaching the final page in a group (either page 2, 3, or 4), pressing **PAGE** once more returns the display to the first page in the group. Refer to the following illustration.

The **PAGE** button can also be used to scroll through pages in the MAIN section.

### Navigating Through a Group Using the PAGE Button

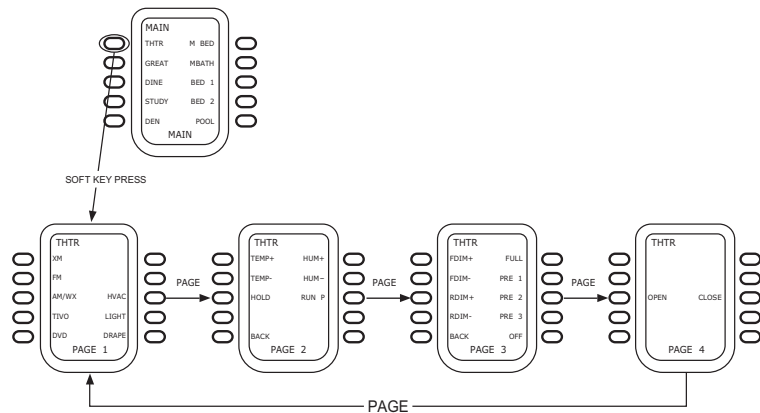

### MAIN

Press **MAIN** at any time to return the LCD to the main page. If **MAIN** is pressed while viewing favorites, the display returns to the page that was displayed before pressing **FAV**.

### FAV

Press **FAV** to view up to five pages containing up to 50 of your favorite functions and/or settings.

Scroll **forward** through the list by pressing **FAV**. Pressing **PAGE** scrolls in reverse as shown in the following diagram.

*Scrolling Through Favorites Using the FAV and PAGE Buttons*

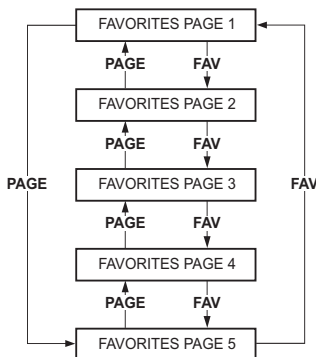

**Hard Keys**

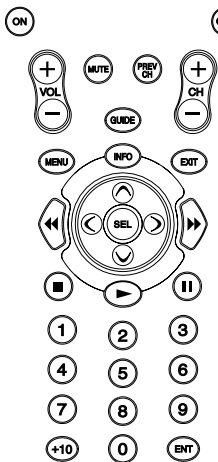

The hard keys are used to switch power to the devices in your system and control device-specific functions within the system.

**ON/OFF**

Use these buttons to switch power to the devices in your system. If the remote’s batteries are running low, the bottom of the LCD display will flash “LOW BATTERY”, whenever the ON button is pressed. Refer to “Installing/Changing the Batteries” on page 8 for instructions on changing batteries.

**Device Control**

These hard keys consist of buttons for volume and channel control, accessing and using on-screen menus, operating transport functions, a numeric keypad and directional control.

The numeric keypad may be used to select a channel when controlling a television, while the transport controls may be used to control a VCR or DVD player.

The directional control buttons can be used to navigate on-screen menus found on A/V devices as well as other functions. To select an on-screen option with the directional controls, press the SEL button.

**LIGHT**



Located on the right side of the remote, the LIGHT button is used to turn the key/display backlighting on and off. For more information on backlighting, refer to “Using the Backlight” on the following page.

**Programming Port**



Located on the left side of the remote, the programming port is used by a Crestron dealer to program the ML-600 for use with a Crestron system. Do not connect any devices to this port.

---

## Miscellaneous

### Using the Backlight

If it is difficult to see the display or buttons when viewing the remote, the ML-600 backlight can be used to light up the display and buttons.

Turn on the backlight by pressing the **LIGHT** button on the right side of the remote control. The backlighting will stay on, and then automatically turn off after approximately 15 seconds. If you wish to turn off the backlighting without waiting, press the **LIGHT** button again.

---

**NOTE :** Battery life is reduced with frequent use of the backlight feature.

---

### Installing/Changing the Batteries

If the batteries are running low, the bottom of the LCD display will flash "LOW BATTERY" whenever the **ON** button is pressed. Low batteries may shorten the operating range of the ML-600. To change the batteries, perform the following:

1. While viewing the back of the ML-600, press the latch on the battery cover (shown in the following illustration) and remove it.

*Battery Cover Removal*

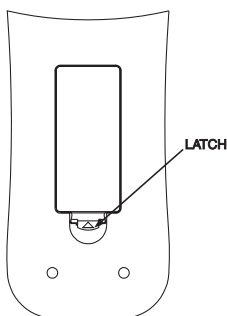

2. Remove old batteries (if installed) and insert new batteries with the indicated polarity inside the battery compartment. The remote will run a diagnostic test.

---

**NOTE :** Replace all of the batteries at the same time. Do not mix old and new batteries.

**NOTE :** The ML-600 will retain its program even when the batteries are removed for an extended period.

---

3. Replace the battery cover.

## Adjusting the Display Contrast

The LCD display's contrast can be adjusted for optimal viewing.

To make the display darker, press the **UP** button while holding the **MAIN** button. Refer to the following diagram.

### Adjusting Display Contrast

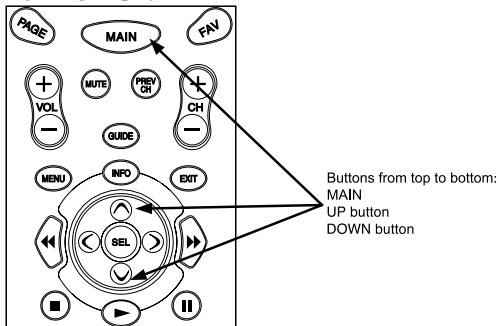

To make the display lighter, press the **DOWN** button while holding the **MAIN** button.

## Cleaning the Screen

**WARNING:** Do not use abrasives or liquid cleaning solutions. Doing so can scratch the LCD or damage internal electrical components.

Use a dry, soft, lint-free cloth to clean the screen. Be careful not to use excessive force. The screen is made of glass and is easily breakable.

# Problem Solving

## Troubleshooting

The table below provides corrective action for possible trouble situations. If further assistance is required, please contact the Crestron dealer that programmed your system.

### *ML-600 Troubleshooting*

TROUBLE	POSSIBLE CAUSE(S)	CORRECTIVE ACTION
Display is too dark.	Contrast is set wrong.	Adjust contrast setting.
Display is too light.	Contrast is set wrong.	Adjust contrast setting.
	Batteries are running low.	Replace batteries.
System does not respond to commands from the ML-600.	Devices are not powered up.	Check power to devices. Check that devices are on.
	Batteries are running low.	Replace batteries.
	RF Gateway not functioning.	Check power to RF Gateway.

## Further Inquiries

If after reviewing this Operations Guide for the ML-600, you cannot locate specific information or have questions, please contact your local Crestron dealer.

## Industry Compliance

As of the date of manufacture, this unit has been tested and found to comply with specifications for CE marking.



---

**NOTE :** This device complies with part 15 of the FCC rules. Operation is subject to the following two conditions: (1) this device may not cause harmful interference, and (2) this device must accept any interference received, including interference that may cause undesired operation.

**NOTE :** This equipment has been tested and found to comply with the limits for a Class B digital device, pursuant to part 15 of the FCC Rules. These limits are designed to provide reasonable protection against harmful interference in a residential installation. The equipment generates, uses and can radiate radio frequency energy and, if not installed and used in accordance with the instructions, may cause harmful interference to radio communications. However, there is no guarantee that interference will not occur in a particular installation. If this equipment does cause harmful interference to radio or television reception, which can be determined by turning the equipment off and on, the user is encouraged to try to correct the interference by one or more of the following measures:

- Reorient or relocate the receiving antenna.
  - Increase the separation between the equipment and transceiver.
  - Connect the equipment into an outlet on a circuit different from that to which the transceiver is connected.
  - Consult the dealer or an experienced radio/TV technician for help.
-



**Crestron Electronics, Inc.**  
15 Volvo Drive Rockleigh, NJ 07647  
Tel: 888.CRESTRON  
Fax: 201.767.7576  
[www.crestron.com](http://www.crestron.com)

**Operations Guide – DOC. 6446  
(2014165)  
02.06**

Specifications subject to  
change without notice.

OCE-0016M REV 01