

Crestron **DM-MD6X1**
6X1 DigitalMedia™ Switcher

Operations Guide



This document was prepared and written by the Technical Documentation department at:



Crestron Electronics, Inc.
15 Volvo Drive
Rockleigh, NJ 07647
1-888-CRESTRON

Regulatory Compliance

This product is Listed to applicable UL Standards and requirements by Underwriters Laboratories Inc.



As of the date of manufacture, the DM-MD6X1 has been tested and found to comply with specifications for CE marking and standards per EMC and Radiocommunications Compliance Labelling.



Federal Communications Commission (FCC) Compliance Statement

This device complies with part 15 of the FCC Rules. Operation is subject to the following conditions:

(1) This device may not cause harmful interference and (2) this device must accept any interference received, including interference that may cause undesired operation.

CAUTION: Changes or modifications not expressly approved by the manufacturer responsible for compliance could void the user's authority to operate the equipment.

NOTE: This equipment has been tested and found to comply with the limits for a Class B digital device, pursuant to part 15 of the FCC Rules. These limits are designed to provide reasonable protection against harmful interference in a residential installation. This equipment generates, uses and can radiate radio frequency energy and, if not installed and used in accordance with the instructions, may cause harmful interference to radio communications. However, there is no guarantee that interference will not occur in a particular installation. If this equipment does cause harmful interference to radio or television reception, which can be determined by turning the equipment off and on, the user is encouraged to try to correct the interference by one or more of the following measures:

- Reorient or relocate the receiving antenna
- Increase the separation between the equipment and receiver
- Connect the equipment into an outlet on a circuit different from that to which the receiver is connected
- Consult the dealer or an experienced radio/TV technician for help

Industry Canada (IC) Compliance Statement

This Class B digital apparatus complies with Canadian ICES-003.

Cet appareil numérique de la classe B est conforme à la norme NMB-003 du Canada.

This device includes an aggregation of separate independent works that are each generally copyrighted by Crestron Electronics, Inc., with all rights reserved. One of those independent works, Linux Bridge Project, is copyrighted under the GNU GENERAL PUBLIC LICENSE, Version 2, reproduced in "GNU General Public License" on page 36, where the corresponding source code is available at: <ftp://ftp.crestron.com/gpl>.

Dolby is a registered trademark of Dolby Laboratories. DTS is a registered trademark of DTS, Inc.
HDMI is a trademark or registered trademarks of HDMI Licensing LLC in the United States and other countries.
©2011 Crestron Electronics, Inc.

Contents

6X1 DigitalMedia™ Switcher: DM-MD6X1	1
Introduction	1
Features and Functions	1
Applications	4
Internal Block Diagram	5
Specifications	6
Physical Description	10
Setup	16
Network Wiring	16
HDCP Signal Path	16
Ethernet Setup	17
Identity Code	18
Installation	18
Hardware Hookup	20
Programming Software	24
Earliest Version Software Requirements for the PC	24
Programming with Crestron SystemBuilder	24
Programming with SIMPL Windows	24
Uploading and Upgrading	28
Establishing Communication	28
Programs and Firmware	29
Program Checks	30
DMTool	30
Operation	31
Problem Solving	32
Check Network Wiring	33
Reference Documents	34
Further Inquiries	34
Future Updates	34
Return and Warranty Policies	35
Merchandise Returns / Repair Service	35
CRESTRON Limited Warranty	35
GNU General Public License	36

6X1 DigitalMedia™ Switcher: DM-MD6X1

Introduction

The Crestron® DM-MD6X1 DigitalMedia™ switcher delivers an incredibly versatile and cost-effective solution for managing a complete range of digital and analog AV sources in a small conference room or classroom, or as part of a larger DigitalMedia distribution system. High-resolution computer signals, standard and high-definition video, stereo analog and digital multichannel audio sources are all handled by the DM-MD6X1, providing a perfect standalone switcher or multiformat interface for installation in an equipment rack or presentation lectern.

Additional DigitalMedia inputs and output allow the DM-MD6X1 to work with the full line of Crestron DM® transmitters, switchers, receivers, and room controllers, affording extensive capabilities for routing and distributing all of today's multimedia AV signal types throughout a single room or larger facility. Combining DM technology with a full complement of analog connections affords a perfect signal converter for integrating DigitalMedia into any analog-based system such as Crestron MPS, QuickMedia®, and the CEN-RGBHV Series (all sold separately).

Features and Functions

- DigitalMedia switcher and interface
- HDMI®, RGB, and multiformat BNC video inputs
- Balanced analog and S/PDIF audio inputs
- 3 DM CAT inputs and 1 DM CAT output
- HDMI and analog stereo audio outputs
- Integrated USB HID (Human Interface Device) keyboard/mouse extender and switch
- Supports HDMI with multichannel lossless audio
- Supports video resolutions up to WUXGA 1920 x 1200 and HD 1080p60
- Detects and reports detailed video and audio input information
- Performs automatic AV signal format management via EDID

(Continued on following page)

Features and Functions

(Continued)

- Allows cable length to 450 feet (~137 meters) using DigitalMedia Cable¹
- QuickSwitch HD[®] technology achieves low-latency HDMI switching
- Enables device control via CEC
- Supports 3D HDTV via DM in/out
- Easy setup and diagnostics tools via software
- Extends the life of analog-based AV systems
- Built-in power distribution for DM transmitters and room controller
- 2-space 19-inch rack-mountable

Multimedia Computer/AV Switcher

Inputs on the DM-MD6X1 include multi-format BNC video, RGB, HDMI[®], balanced line level and S/PDIF digital audio. The HDMI input supports HDMI with HDCP, handling WUXGA computer resolutions and 1080p60 HDTV with multichannel lossless audio. The HDMI input can also handle DVI and DisplayPort Multimode signals using an appropriate adapter or dongle². The RGB input handles analog RGB signals up to WUXGA 1920x1200 pixels, as well as component video up to 1080p60³. The multi-format BNC input also accepts component HDTV signals up to 1080p60, as well as standard definition NTSC/PAL composite and S-video. Dedicated audio inputs include two stereo balanced line level analog and one S/PDIF coaxial digital.

Additional inputs are easily added at locations up to 450 feet (~137 m)¹ away using DM Transmitters. Three CAT-type DM inputs are provided on the DM-MD6X1, accepting inputs from individual DM Transmitters as well as other DM switchers. A single DM CAT output is provided to drive a DM Receiver/Room Controller at the display location, or to feed another DM switcher. HDMI and analog audio outputs are also included to feed a local video display and audio system. The analog stereo output includes professional balanced terminals and programmable volume control.

DigitalMedia

As the leader in HDMI and control system technologies, Crestron has developed DigitalMedia, the first complete HD AV distribution system that takes HDMI to a higher level, and allows virtually any mix of AV sources to be distributed throughout the home, office, school, or virtually any other facility.

DigitalMedia distributes uncompressed digital video and audio signals up to 450 feet (~137 m) using DM cable¹. DigitalMedia thoughtfully manages all of the different signals and devices, matching each source's output to the capabilities of the selected display(s) without using scaling or compression. Every signal is preserved in its native video resolution and audio format, ensuring a pure, lossless signal path throughout.

1. For DigitalMedia CAT wiring, use DM-CBL DigitalMedia Cable. Up to two DM Repeaters (model DM-DR, sold separately) may be required. Refer to the latest version of the Crestron DigitalMedia Design Guide (Doc. 4789) for complete wiring guidelines. It is available from the Crestron Web site (www.crestron.com/dmresources).
2. HDMI requires an appropriate adapter or interface cable to accommodate a DVI or DisplayPort Multimode signal. CBL-HD-DVI and CBL-DP-HD interface cables available separately.
3. The RGB input can accept component, composite, and S-video signals via direct interface to Crestron MPS Series products, or through an appropriate adapter (all sold separately). Input sync detection is not provided for composite or S-video signal types through the RGB connection.

QuickSwitch HD® Technology

Crestron exclusive QuickSwitch HD® technology minimizes the annoying switching latency that plagues typical HDMI switchers. QuickSwitch HD achieves very fast switching of HDMI signals by maintaining a constant HDCP connection with each HDMI device in the system, eliminating the need to re-authenticate each time a different source is selected.

Keyboard/Mouse Extender

The DM-MD6X1 also functions as a keyboard/mouse extender and switcher, allowing a computer or other USB HID-compliant host device connected to the DM-MD6X1 to be controlled by a keyboard and mouse at the display location using a DM-RMC-100-1 room controller (sold separately), or at a presenter's location using select DM transmitters.

EDID Format Management

The DM-MD6X1 allows for management of the EDID (Extended Display Identification Data) information that passes between the display devices and input sources in the system. Using Crestron Toolbox™ software, the format and resolution capabilities of each device can be assessed and managed through the DM-MD6X1, ensuring reliable operation by instructing sources to output only the resolutions and formats that can be handled by the displays and system wiring.

CEC Embedded Device Control

The primary objective of every Crestron system is to enable precisely the control desired for a seamless user experience. DigitalMedia provides an alternative to conventional IR and RS-232 device control by harnessing the CEC (Consumer Electronics Control) signal embedded in HDMI. Through its connection to the control system, the DM-MD6X1 provides a gateway for controlling AV devices right through their HDMI connections, potentially eliminating the need for any dedicated control wires or IR probes. Through proper CEC signal management, DigitalMedia allows you to take control of each device in the system as you like.

Easy Setup

The DM-MD6X1 is designed to be placed on a shelf or mounted in an equipment rack or lectern. The front panel provides basic operation right out of the box. User-friendly setup and troubleshooting tools are provided via Crestron Toolbox software, performing automatic input and output configuration while letting the installer make intelligent design decisions along the way. The switcher even tests and measures the length of each DM cable, automatically making the appropriate calibrations for optimal signal transmission to each DM device.

A Digital Upgrade for Legacy Systems

The DM-MD6X1 also affords a perfect signal converter for integrating DigitalMedia with analog-based systems like Crestron MPS, QuickMedia®, and the CEN-RGBHV Series (all sold separately). A simple HD15 VGA cable connected between the output of an MPS system and the input of the DM-MD6X1 allows every RGB, component, S-video, and composite video input on the MPS to be converted to DigitalMedia*. Analog audio is converted similarly through a simple balanced stereo audio cable. The DM-MD6X1's HDMI and DM inputs may also be used to expand the input capabilities of the MPS system to handle digital AV sources, and its analog audio output can easily be fed into any spare input on the MPS system to allow the digital audio signals to be amplified and controlled through the MPS system.

Applications

The following diagram shows a DM-MD6X1 in a lecture hall application.

DM-MD6X1 in a Lecture Hall Application

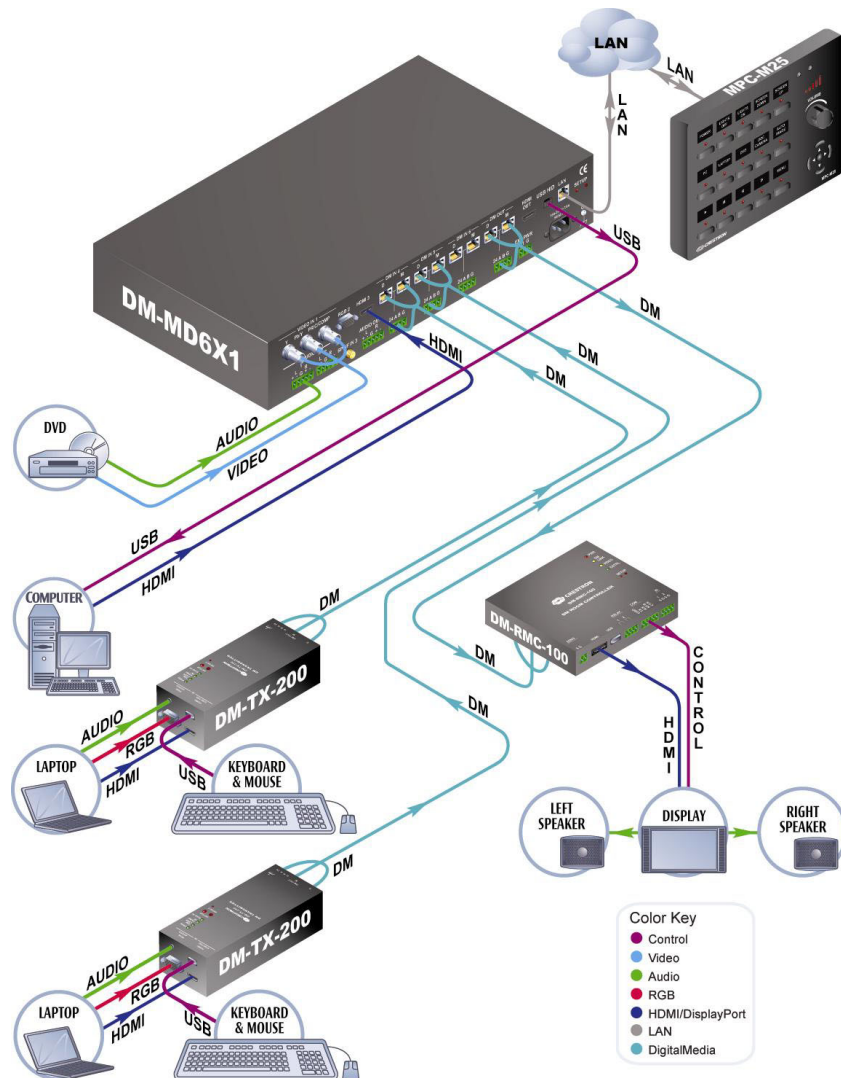

* The RGB input can accept component, composite, and S-video signals via direct interface to Crestron MPS Series products, or through an appropriate adapter (sold separately). Input sync detection is not provided for composite or S-video signal types through the RGB connection.

Internal Block Diagram

The following diagram represents the signal path through the DM-MD6X1.

Internal Block Diagram of the DM-MD6X1

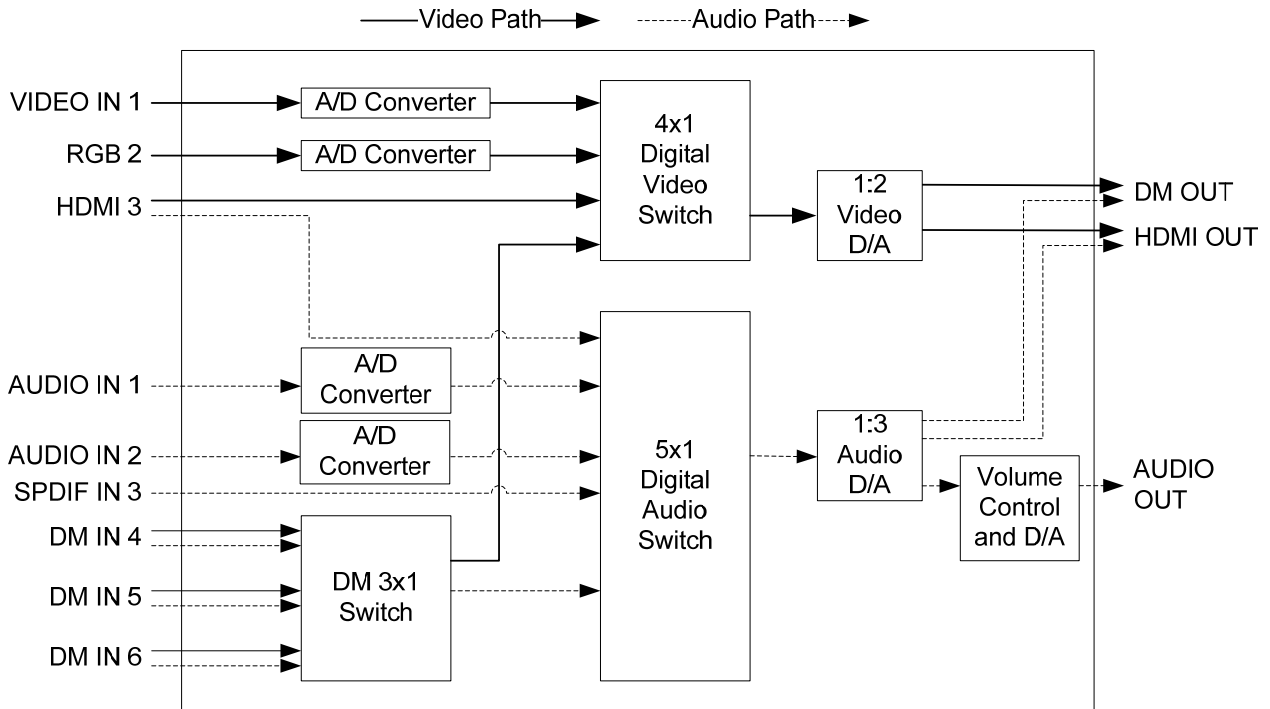

The following table shows valid audio breakaway routes through the DM-MD6X1. If an invalid route is established, video will be transmitted but audio will not.

		Audio					
		AUDIO IN 1 / S/PDIF IN 3	AUDIO IN 2	HDMI 3	DM 4	DM 5	DM 6
Video	VIDEO IN 1	✓	✓	⊘	✓	✓	✓
	RGB 2	✓	✓	⊘	✓	✓	✓
	HDMI 3	✓	✓	✓	✓	✓	✓
	DM 4	✓	✓	✓	✓	⊘	⊘
	DM 5	✓	✓	✓	⊘	✓	⊘
	DM 6	✓	✓	✓	⊘	⊘	✓

Specifications

Specifications for the DM-MD6X1 are listed in the following table.

DM-MD6X1 Specifications

SPECIFICATION	DETAILS
Video	
Switcher	6x1 combination digital/analog switch, Crestron QuickSwitch HD
Input Signal Types	DM CAT (DigitalMedia over shielded twisted-pair copper wire), HDMI, DVI ¹ , DisplayPort Multimode ¹ , RGB, component (YPbPr) ² , S-video (Y/C) ² , composite ²
Output Signal Types	DM CAT, HDMI, DVI ¹
Formats	HDMI, DVI, HDCP content protection support, 3D (via DM inputs only), RGBHV up to UXGA/WUXGA, HDTV up to 1080p60, NTSC or PAL
Input Resolutions, HDMI, Progressive	640 x 480 @ 60 Hz 720 x 480 @ 60 Hz (480p) 720 x 576 @ 50 Hz (576p) 800 x 600 @ 60 Hz 848 x 480 @ 60 Hz 852 x 480 @ 60 Hz 854 x 480 @ 60 Hz 1024 x 768 @ 60 Hz 1024 x 852 @ 60 Hz 1024 x 1024 @ 60 Hz 1280 x 720 @ 50 Hz (720p50) 1280x720 @ 60 Hz (720p60) 1280 x 768 @ 60 Hz 1280 x 800 @ 60 Hz 1280 x 960 @ 60 Hz 1280 x 1024 @ 60 Hz 1360 x 768 @ 60 Hz 1365 x 1024 @ 60 Hz 1366 x 768 @ 60 Hz 1400 x 1050 @ 60 Hz 1440 x 900 @ 60 Hz 1600 x 900 @ 60 Hz 1600 x 1200 @ 60 Hz 1680 x 1050 @ 60 Hz 1920 x 1080 @ 24 Hz (1080p24) 1920 x 1080 @ 25 Hz (1080p25) 1920 x 1080 @ 50 Hz (1080p50) 1920 x 1080 @ 60 Hz (1080p60) 1920 x 1200 @ 60 Hz 2048 x 1080 @ 24 Hz 2048 x 1152 @ 60 Hz plus any other resolution allowed by HDMI up to 165 MHz pixel clock
Input Resolutions, HDMI, Interlaced	720 x 480 @ 30 Hz (480i) 720 x 576 @ 25 Hz (576i) 1920 x 1080 @ 25 Hz (1080i25) 1920 x 1080 @ 30 Hz (1080i30) plus any other resolution allowed by HDMI up to 165 MHz pixel clock

(Continued on following page)

DM-MD6X1 Specifications (Continued)

SPECIFICATION	DETAILS
Video (Continued)	
Input Resolutions, RGB	640 x 480 @ 60 Hz 720 x 480 @ 60 Hz (480p) 720 x 576 @ 50 Hz (576p) 800 x 600 @ 60 Hz 848 x 480 @ 60 Hz 1024 x 768 @ 60 Hz 1280 x 720 @ 50 Hz (720p50) 1280 x 720 @ 60 Hz (720p60) 1280 x 768 @ 60 Hz 1280 x 800 @ 60 Hz 1280 x 960 @ 60 Hz 1280 x 1024 @ 60 Hz 1360 x 768 @ 60 Hz 1366 x 768 @ 60 Hz 1400 x 1050 @ 60 Hz 1440 x 900 @ 60 Hz 1600 x 1200 @ 60 Hz 1680 x 1050 @ 60 Hz 1920 x 1080 @ 24 Hz (1080p24) 1920 x 1080 @ 50 Hz (1080p50) 1920 x 1080 @ 60 Hz (1080p60) 1920 x 1200 @ 60 Hz 2048 x 1080 @ 24 Hz 2048 x 1152 @ 60 Hz
Input Resolutions, Component	480i 576i 480p 576p 720p50 720p60 1080i25 (1125 lines) 1080i30 1080p30 1080p50 (1125 lines) 1080p60
Input Resolutions, Composite and S-video	480i 576i
Output Resolutions	Matched to inputs
Analog-To-Digital Conversion	10-bit 165 MHz per each of three channels
Audio	
Switcher	6x1 combination digital/analog switch, limited audio breakaway ³ ; independent input compensation and master volume adjustment for analog output
Input Signal Types	DM CAT, HDMI, DisplayPort Multimode ¹ , S/PDIF coaxial, analog stereo
Output Signal Types	DM CAT, HDMI, analog stereo
Formats, HDMI and S/PDIF	Dolby® Digital, Dolby Digital EX, DTS®, DTS-ES, DTS 96/24, 2ch PCM
Formats, HDMI only	Up to 8ch PCM
Formats, Analog	Stereo 2-Channel

(Continued on following page)

DM-MD6X1 Specifications (Continued)

SPECIFICATION	DETAILS
Audio (Continued)	
Analog-To-Digital Conversion	24-bit 48 kHz
Digital-To-Analog Conversion	24-bit 48 kHz
Volume Gain Range (analog out)	-80 dB to 0 dB, adjustable from 0% to 100%
Input Compensation (analog out)	±10 dB per input
Performance (analog)	
Frequency Response	20 Hz to 20 kHz ±0.75 dB
S/N Ratio	>90 dB, 20 Hz to 20 kHz A-weighted
THD+N	<0.05% @ 1 kHz
Stereo Separation	>90 dB
Communications	
DigitalMedia	DM CAT, DMNet, HDCP management, EDID format management, CEC
Ethernet	10BASE-T/100BASE-TX, auto-switching, auto-negotiating, auto-discovery, full/half duplex, TCP/IP, UDP/IP, CIP, DHCP, RSTP
USB	Supports USB HID class devices
Ethernet Switch	Provides (1) onboard 10BASE-T/100BASE-TX Ethernet port, (1) internal 10BASE-T/100BASE-TX Ethernet port for the switcher, and (4) remote 10BASE-T/100BASE-TX Ethernet ports via select outboard devices
Power Requirements	
Main Power	90 Watts @ 100-240 Volts AC, 50/60 Hz
Available DMNet Power	30 Watts (1.25 Amps @ 24 Volts DC) from internal power supply
Default IP ID	03
Minimum 2-Series Control System Update File ^{4, 5, 6}	Version 4.003.0015 or later
Environmental	
Temperature	32° to 104°F (0° to 40°C)
Humidity	10% to 90% RH (non-condensing)
Heat Dissipation	307 BTU/hr
Enclosure	
Chassis	Metal with black finish, vented sides, fan-cooled
Faceplate	Extruded aluminum, black finish with polycarbonate label overlay
Mounting	Freestanding or 2U 19-inch rack-mountable (adhesive feet and rack ears included)

(Continued on following page)

DM-MD6X1 Specifications (Continued)

SPECIFICATION	DETAILS
Dimensions	
Height	3.47 in (89 mm) without feet
Width	17.03 in (433 mm) 19.00 in (483 mm) with ears
Depth	12.21 in (310 mm)
Weight	7.5 lb (3.4 kg)
Available Accessories	
CBL-DP-HD	Crestron Certified DisplayPort to HDMI Interface Cable
CBL-HD	Crestron Certified HDMI Interface Cable
CBL-HD-DVI	Crestron Certified HDMI to DVI Interface Cable
CBL-RCA	Crestron Certified RCA Coaxial Digital Audio Interface Cable
CBL-VGA	Crestron Certified DB15HD Computer VGA Interface Cable
DM-CBL	DigitalMedia Cable
DM-CONN	DigitalMedia Cable Connector
DM-DR	DigitalMedia CAT Repeater
MP-WP130	Media Presentation Wall Plate - DB15HD Computer VGA with Mini-TRS Stereo Audio, Bulkhead
MP-WP131	Media Presentation Wall Plate - DB15HD Computer VGA w/Mini-TRS Stereo Audio, Breakout
MP-WP140	Media Presentation Wall Plate – DVI with Mini-TRS Stereo Audio
MP-WP150	Media Presentation Wall Plate - HDMI with Mini-TRS Stereo Audio
MP-WP152	Media Presentation Wall Plate – HDMI
MP-WP160	Media Presentation Wall Plate - DisplayPort with Mini-TRS Stereo Audio
MP-WP162	Media Presentation Wall Plate – DisplayPort
MP-WP185	Media Presentation Wall Plate - Crestron DigitalMedia CAT with DMNet

- HDMI requires an appropriate adapter or interface cable to accommodate a DVI or DisplayPort Multimode signal. CBL-HD-DVI and CBL-DP-HD interface cables available separately.
- The RGB input can accept component, composite, and S-video signals via direct interface to Crestron MPS Series products, or through an appropriate adapter (not included). Input sync detection is not provided for composite or S-video signal types through the RGB connection.
- Audio breakaway capabilities and limitations: **AUDIO/SPDIF IN 1** and **AUDIO IN 2** may each be switched freely regardless which video input is selected; **HDMI IN 3** audio may be switched freely only when **HDMI IN 3** video, or any **DM IN** video input, is selected; **HDMI IN 3** audio cannot be selected when **VIDEO IN 1** or **RGB IN 2** video inputs are selected; **DM IN 4**, **DM IN 5**, and **DM IN 6** audio may each be switched freely except when any other numbered **DM IN** video input is selected; **AUDIO IN 1** and **SPDIF IN 1** inputs are mutually exclusive.
- The latest software versions can be obtained from the Crestron Web site. Refer to the NOTE following these footnotes.
- Crestron 2-Series control systems include the AV2 and PRO2. Consult the latest Crestron Product Catalog for a complete list of 2-Series control systems.

- When loading firmware through the RS-232 port of the control system, be sure that the baud rate is at 38400 (Cresnet® speed) or lower. Otherwise, Toolbox may post the “Transfer Failed” message.

NOTE: Crestron software and any files on the Web site are for authorized Crestron dealers and Crestron Authorized Independent Programmers (CAIP) only. New users may be required to register to obtain access to certain areas of the site (including the FTP site).

Physical Description

This section provides information on the connections, controls and indicators available on your DM-MD6X1.

DM-MD6X1 Physical View



DM-MD6X1 Physical View

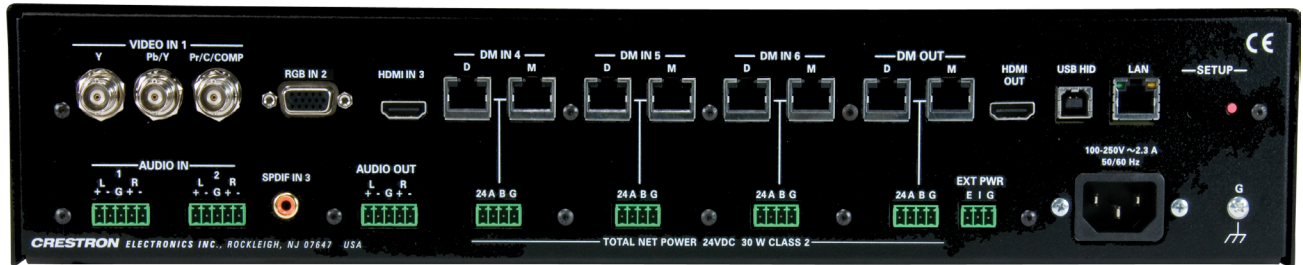

DM-MD6X1 Overall Dimensions (Front View)

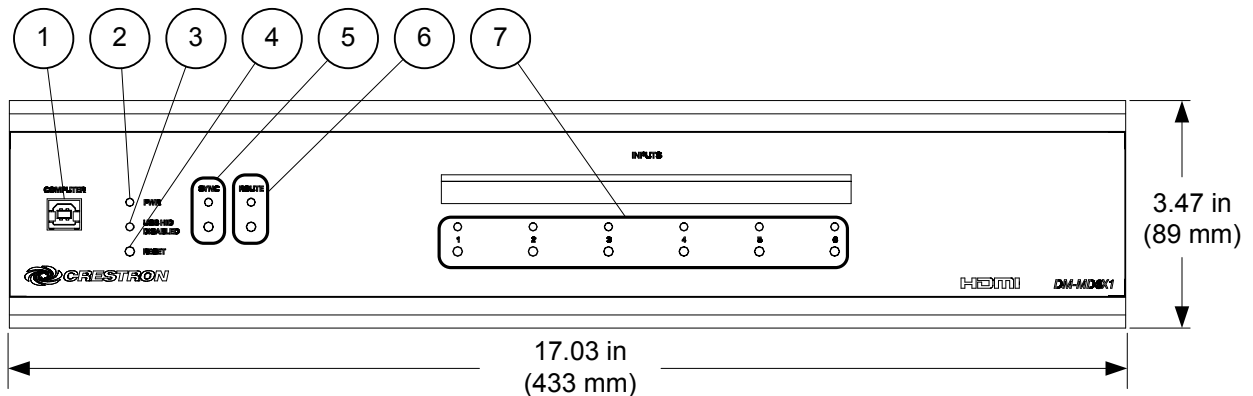

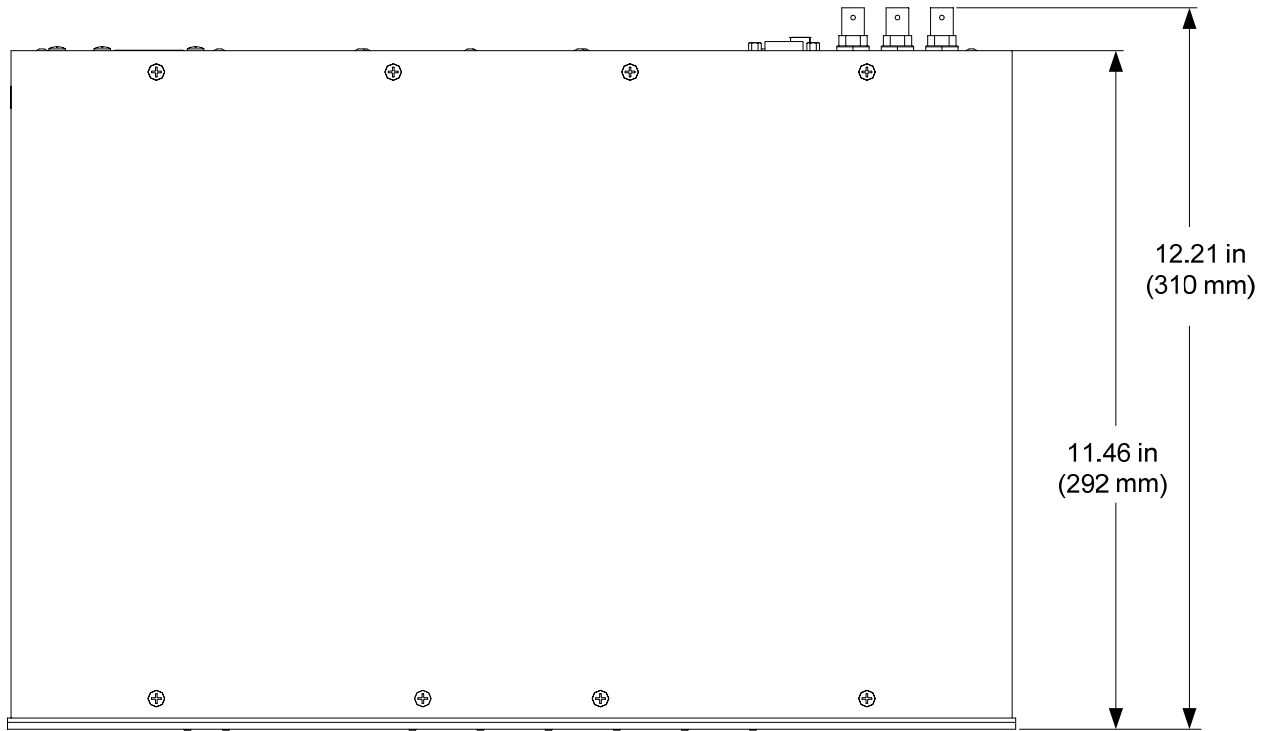

DM-MD6X1 Overall Dimensions (Top View)

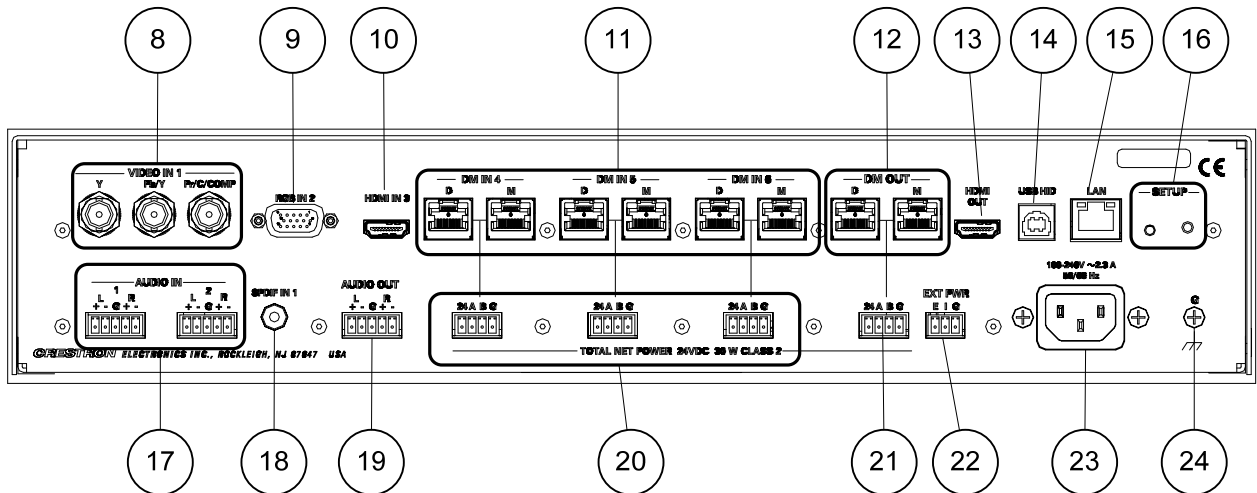

DM-MD6X1 Overall Dimensions (Rear View)



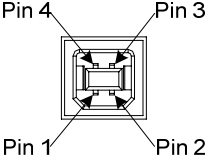
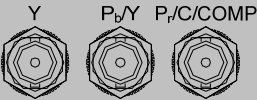
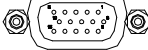

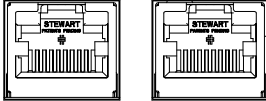

Connectors, Controls & Indicators

#	CONNECTORS ¹ , CONTROLS & INDICATORS	DESCRIPTION										
1	COMPUTER (front) Pin 4 Pin 3 Pin 1 Pin 2 	(1) USB Type B female USB 1.1 computer console port (6 ft cable included) <table border="1"> <thead> <tr> <th>PIN</th> <th>DESCRIPTION</th> </tr> </thead> <tbody> <tr> <td>1</td> <td>+5 VDC</td> </tr> <tr> <td>2</td> <td>Data -</td> </tr> <tr> <td>3</td> <td>Data +</td> </tr> <tr> <td>4</td> <td>Ground</td> </tr> </tbody> </table>	PIN	DESCRIPTION	1	+5 VDC	2	Data -	3	Data +	4	Ground
PIN	DESCRIPTION											
1	+5 VDC											
2	Data -											
3	Data +											
4	Ground											
2	PWR LED	(1) Green LED, indicates operating power supplied via main power input										
3	USB HID DISABLED	(1) Red LED, indicates the COMPUTER port is in use, causing USB HID to be disabled										
4	RESET	(1) Recessed miniature push button for hardware reset, reboots the switcher										
5	SYNC (Button and LED)	(1) Push button and red LED, selects <i>Sync</i> mode so the INPUTS LEDs indicate input signal presence										
6	ROUTE (Button and LED)	(1) Push button and red LED, selects <i>Route</i> mode to allow routing changes										
7	INPUTS 1 – 6 (Buttons and LEDs)	(6) Push buttons and red LEDs, select input for routing										
8	VIDEO IN 1 Y P _b Y P _r /C/COMP 	(3) BNC female comprising (1) auto-sensing multi-format analog video input; Signal Types: Component (YP _b P _r), S-video (Y/C), or composite input; Input Level: 1 V _{p-p} nominal Input Impedance: 75 Ohms nominal										
9	RGB IN 2 ² 	(1) DB15HD female, RGB (VGA) or component (YP _b P _r) video input ³ ; Formats: RGBHV, RGBS, RG _s B, YP _b P _r ; Input Levels: 0.5 to 1.5 V _{p-p} with built-in DC restoration Input Impedance: 75 Ohms Sync Input Type: Autodetect RGBHV, RGBS, RG _s B, YP _b P _r Sync Input Level: 3 to 5 V _{p-p} Sync Input Impedance: 1k Ohms										
10	HDMI IN 3 	(1) 19-pin Type A HDMI female; HDMI digital video/audio input										
11	DM IN D/M (4 – 6) ^{4, 5, 6} D M 	(3) DM CAT inputs, each composed of (2) 8-pin RJ-45 female, shielded; Connect to DM CAT outputs of DM transmitters or other DM devices via DM-CBL cable										

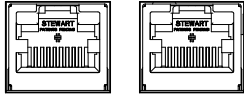

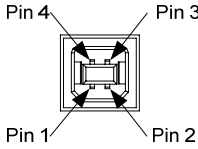
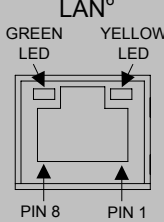
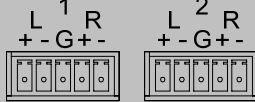

(Continued on following page)

Connectors, Controls & Indicators (Continued)

#	CONNECTORS ¹ , CONTROLS & INDICATORS	DESCRIPTION																				
12	DM OUT D/M ^{4, 5, 6} 	(1) DM CAT output composed of (2) 8-pin RJ-45 female, shielded; Connect to DM CAT input of a DM receiver/room controller, switcher, or other DM device via DM-CBL cable																				
13	HDMI OUT 	(1) 19-pin Type A HDMI female; HDMI digital video/audio output; Carries same audio and video signals as DM OUT																				
14	USB HID 	(1) USB Type B female; USB 1.1 device port for connection to the USB host interface of a computer or other USB HID-compliant host device																				
15	LAN ⁶ 	(1) 8-pin RJ-45 female with two LED indicators; 10BASE-T/100BASE-TX Ethernet port; Green LED indicates link status; Yellow LED indicates Ethernet activity																				
		<table border="1"> <thead> <tr> <th>PIN</th> <th>SIGNAL</th> <th>PIN</th> <th>SIGNAL</th> </tr> </thead> <tbody> <tr> <td>1</td> <td>TX +</td> <td>5</td> <td>N/C</td> </tr> <tr> <td>2</td> <td>TX -</td> <td>6</td> <td>RX -</td> </tr> <tr> <td>3</td> <td>RX +</td> <td>7</td> <td>N/C</td> </tr> <tr> <td>4</td> <td>N/C</td> <td>8</td> <td>N/C</td> </tr> </tbody> </table>	PIN	SIGNAL	PIN	SIGNAL	1	TX +	5	N/C	2	TX -	6	RX -	3	RX +	7	N/C	4	N/C	8	N/C
PIN	SIGNAL	PIN	SIGNAL																			
1	TX +	5	N/C																			
2	TX -	6	RX -																			
3	RX +	7	N/C																			
4	N/C	8	N/C																			
16	SETUP (rear) (Button and LED)	(1) Red LED and (1) miniature recessed push button for Ethernet auto-discovery																				
17	AUDIO IN 1 – 2 	(2) 5-pin 3.5 mm detachable terminal blocks; Balanced/unbalanced stereo line-level inputs; AUDIO IN 1 and SPDIF IN 1 inputs are mutually exclusive; Input Impedance: 24k Ohms balanced/unbalanced Balanced Input Level: 4 V _{rms} maximum Unbalanced Input Level: 2 V _{rms} maximum																				
18	SPDIF IN 1 	(1) RCA female, S/PDIF coaxial digital audio input; SPDIF IN 1 and AUDIO IN 1 inputs are mutually exclusive; Input Impedance: 75 Ohms																				
19	AUDIO OUT ⁷ 	(1) 5-pin 3.5 mm detachable terminal block; Balanced/unbalanced stereo line-level output, variable level; Output Impedance: 200 Ohms balanced, 100 Ohms unbalanced Maximum Output Level: 4 V _{rms} balanced, 2 V _{rms} unbalanced																				

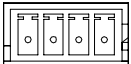
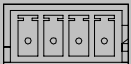
(Continued on following page)

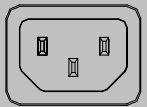
Connectors, Controls & Indicators (Continued)

#	CONNECTORS ¹ , CONTROLS & INDICATORS	DESCRIPTION
20	DM IN 24 A B G (4-6) ^{8, 9, 10} 24 A B G 	(3) 4-pin 3.5 mm detachable terminal blocks, DMNet ports; Connects to DMNet ports of DM transmitters or other DM devices via DM-CBL cable ⁴
21	DM OUT 24 A B G ^{8, 9, 10} 24 A B G 	(1) 4-pin 3.5 mm detachable terminal block, DMNet port; Connects to DMNet port of a DM receiver/room controller, switcher, or other DM device via DM-CBL cable ⁴
22	EXT PWR ¹⁰ E I G 	(1) 3-pin 3.5 mm detachable terminal block, power selection port; Connects to an external power supply ¹¹ , or to the internal power source via a jumper, to power the DM devices connected to DM IN 4 – 6 and DM OUT ; Maximum Load: 75 Watts (3.13 Amps @ 24 Volts DC) total for all ports when connected to external power supply ¹¹ , otherwise limited to available DMNet power (refer to "Power Requirements" in the "Specifications" table which begins on page 6).
23	100-240V ~2.3A 50/60Hz 	(1) IEC C14 male chassis plug, main power input; Mates with removable power cord, included
24	G 	(1) 6-32 screw, chassis ground lug

1. Interface connectors for **24 A B G**, **EXT PWR**, **AUDIO IN** and **AUDIO OUT** ports are provided with the unit.
2. Refer to the following table for the **RGB** connector pinouts.

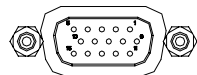
				
PIN #	RGB	YP _b P _r	S-VIDEO	COMPOSITE
1	R	P _r	C	
2	G	Y	Y	
3	B	P _b		Comp
13	H			
14	V			

3. The RGB input can accept component, composite and S-video signals via direct interface to Crestron MPS Series products (sold separately) or through an appropriate adapter (not included). Input sync detection is not provided for composite or S-video signal types through the RGB connection.

4. For DigitalMedia CAT wiring, use DM-CBL DigitalMedia Cable. Up to two DM Repeaters (model DM-DR, sold separately), may be required. Refer to the latest version of the Crestron DigitalMedia Design Guide (Doc. 4789) for complete wiring guidelines.
5. The **DM OUT** port consists of two separate RJ-45 connectors labeled **D** and **M**. The **D** port carries HDMI signal. The **M** port carries data. Refer to the following table for the connector pinouts.

	
PIN #	WIRE COLOR
1	Orange/White
2	Orange
3	Green/White
4	Blue
5	Blue/White
6	Green
7	Brown/White
8	Brown

6. To determine which is pin 1 on the cable, hold the cable so the end of the eight pin modular jack is facing away from you, with the clip down and copper side up. Pin 1 is on the far left.
7. The source gain compensation only has an effect on the analog audio output (**AUDIO OUT**) and has no effect on the DM or HDMI outputs. In addition, the total gain at the output will never exceed 0 dB, as the total output range is -80 dB to 0 dB. This signifies that a +10 dB input compensation will start to decrease to 0 dB as the output volume increases from -10 dB to 0 dB.
8. DMNet wiring is not compatible with Cresnet wiring. DMNet wiring cannot be daisy chained.
9. Refer to the following table for the **24 A B G** connector pinouts.

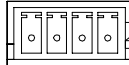
			
PIN #	SIGNAL	DESCRIPTION	WIRE COLOR
G	Ground	DC Ground	Black
B	DMNet-	DMNet	Grey
A	DMNet+	DMNet	Orange
24	24V DC	DC Power	Red

10. If a DM switcher or other DM device is supplying power and is connected to a **DM** port of the DM-MD6X1 or other DM midpoint, then the **+24V** wire between the DM device and the DM-MD6X1 must be disconnected. The **A B G** wires must remain connected.
11. For external DMNet power, use a Crestron CNPWS-75, C2N-SPWS300 (both sold separately), or other Cresnet power supply as required. Do not interconnect DMNet with Cresnet.

Setup

Network Wiring

When wiring the DM network, consider the following:

NOTE: DMNet wiring and Cresnet® wiring are not compatible.

- Use Crestron Certified Wire.
- Use Crestron power supplies for Crestron equipment.
- Provide sufficient power to the system.

CAUTION: Insufficient power can lead to unpredictable results or damage to the equipment. Use the Crestron Power Calculator to help calculate how much power is needed for the system (www.crestron.com/calculators).

- For DigitalMedia CAT wiring, use DM-CBL DigitalMedia Cable. Up to two DM Repeaters (model DM-DR, sold separately) may be required. Refer to the latest revision of the Crestron DigitalMedia Design Guide (Doc. 4789) for complete wiring guidelines.

The DM-MD6X1 can also use high-speed Ethernet for communications between the device and a control system, computer, media server and other IP-based devices. For general information on connecting Ethernet devices in a Crestron system, refer to the latest version of the Crestron e-Control® Reference Guide (Doc. 6052), which is available from the Crestron Web site (www.crestron.com/manuals). For information specifically related to Ethernet connectivity using DigitalMedia devices, refer to the latest version of the Crestron IP Considerations Guide (Doc. 4579), which is also available from the Crestron Web Site (www.crestron.com/dmresources).

HDCP Signal Path

Sources using HDCP limit the number of display devices it can transmit to while simultaneously limiting the depth of devices in the signal path. Too many devices or greater than allowed depth in a signal path (from source to display) may create problems with displaying audio and video content. The HDCP specification states that the maximum depth of devices between source and display is six. Some examples are shown in the following diagrams.

Examples of Reported HDCP Devices and Reported HDCP Depth

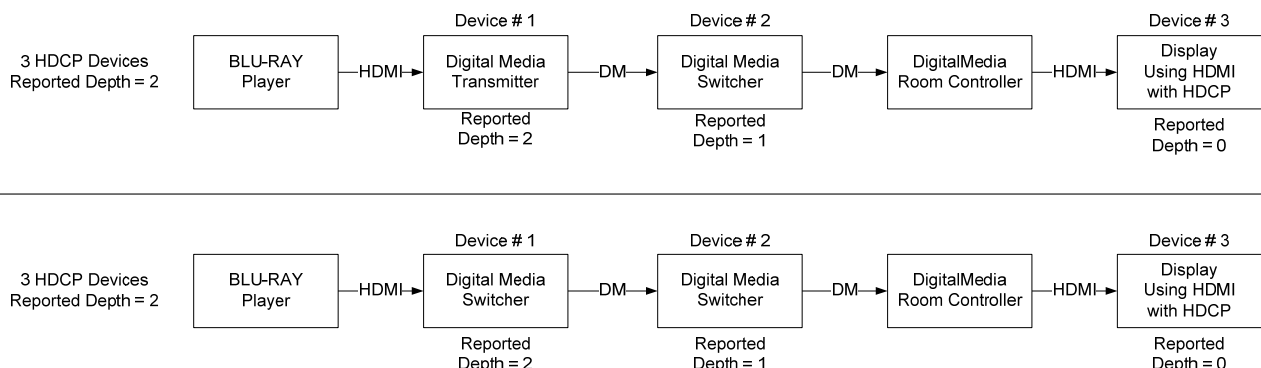

Examples of Reported HDCP Devices and Reported HDCP Depth (Continued)

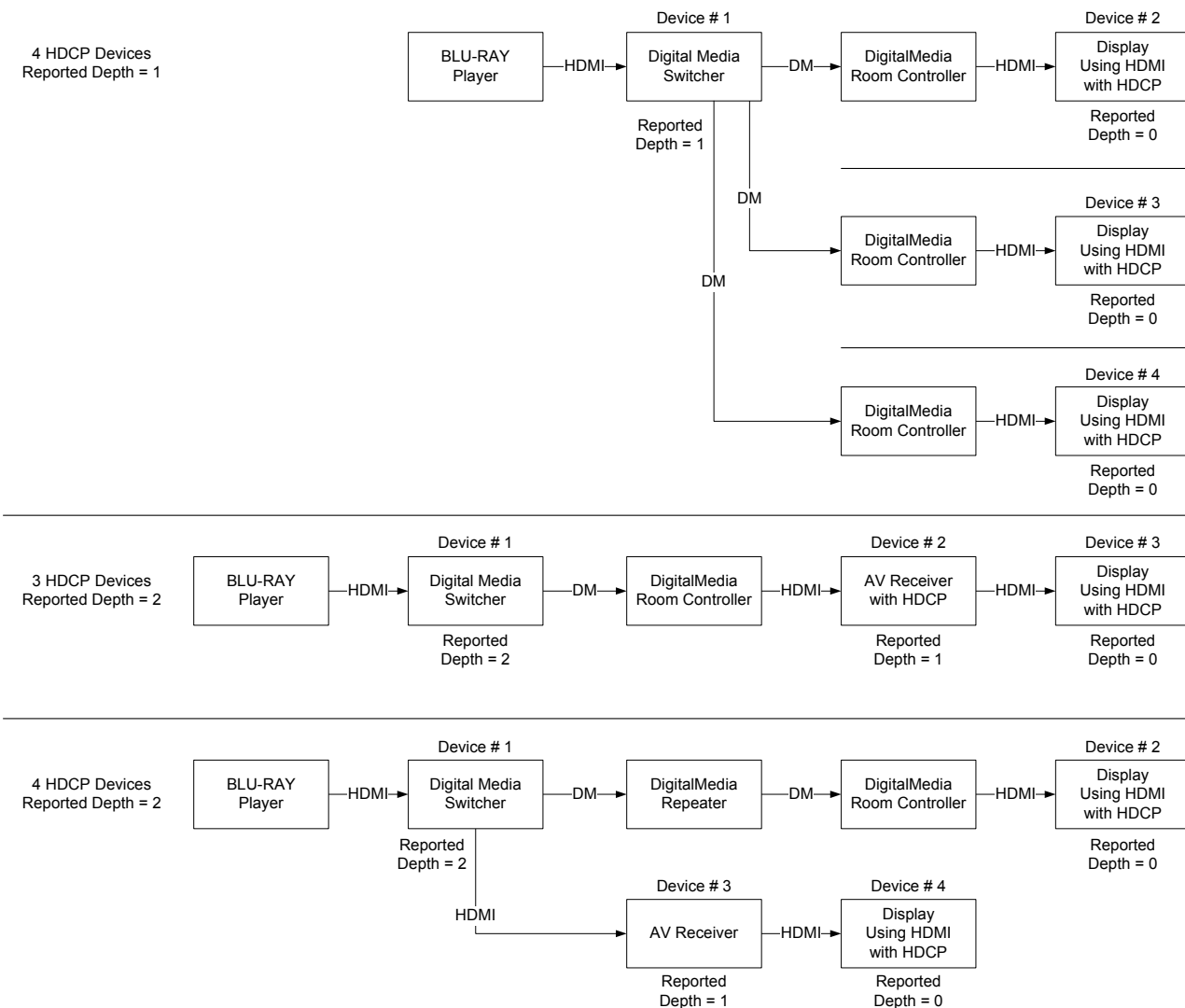

Ethernet Setup

DigitalMedia switchers are designed to control the Ethernet settings of lightweight DM devices around them in order to reduce the amount of IP configuration necessary and make the certain DM devices swappable without reconfiguration.

IP Configuration

DigitalMedia switchers have the ability to operate in *DHCP* or *Static IP* address mode. In addition, DM switchers control the IP addressing information for input cards that have Ethernet capabilities as well as neighboring DigitalMedia devices. When the DM switcher is set to *DHCP* mode, these cards and DM devices will also be set to *DHCP* mode. When the DM switcher is set into *Static IP* mode, these cards and DM devices will receive a *Static IP* configuration equivalent to the DM switcher's IP address plus their slot number. This configuration is sent when the DM switcher starts up.

Example:

A DM-MD6X1 is set to IP address 192.168.1.30. The IP mask is 255.255.255.0 and the default router is 192.168.1.1. The HDMI input card on slot 3 would be set to IP

address 192.168.1.33 and receive the same IP mask and default router as the DM switcher.

Since there can be up to 32 slots in the DigitalMedia switcher, the last octet in the DM switcher IP address may not be set higher than 236. Otherwise not all devices will receive a valid IP address.

The DM-MD6X1 sends this IP configuration to other DigitalMedia devices in the system.

DigitalMedia devices that receive this IP configuration are the DMC-HD, DMC-HD-DSP, DMC-DVI, DM-RMC-100, DM-RMC-100-F, DM-TX-100, and DM-TX-200.

IP Table Setup

DigitalMedia devices that receive their IP address configuration via the switcher can also receive their IP table configuration from the DM switcher.

For more information, refer to “IP Table Options” on page 25.

Identity Code

The IP ID is set within the DM-MD6X1’s table using Crestron Toolbox. For information on setting an IP table, refer to the Crestron Toolbox help file. The IP IDs of multiple DM-MD6X1 devices in the same system must be unique.

When setting the IP ID, consider the following:

- The IP ID of each unit must match an IP ID specified in the SIMPL™ Windows program.
- Each device using IP to communicate with a control system must have a unique IP ID.

Installation

Ventilation

The DM-MD6X1 should be used in a well-ventilated area. The venting holes should not be obstructed under any circumstances.

To prevent overheating, do not operate this product in an area that exceeds the environmental temperature range listed in the table of specifications. Consider using forced air ventilation and/or incrementing the spacing between units to reduce overheating. Consideration must be given if installed in a closed or multi-unit rack assembly since the operating ambient temperature of the environment may be greater than the room ambient temperature. Contact with thermal insulating materials should be avoided on all sides of the unit.

Rack Mounting

The DM-MD6X1 can be mounted in a rack or stacked with other equipment. Two “ears” are provided with the DM-MD6X1 so that the unit can be rack mounted. These ears must be installed prior to mounting. Complete the following procedure to attach the ears to the unit. The only tool required is a #1 or #2 Phillips screwdriver.

WARNING: To prevent bodily injury when mounting or servicing this unit in a rack, take special precautions to ensure that the system remains stable. The following guidelines are provided to ensure your safety:

- When mounting this unit in a partially filled rack, load the rack from the bottom to the top with the heaviest component at the bottom of the rack.
 - If the rack is provided with stabilizing devices, install the stabilizers before mounting or servicing the unit in the rack.
-

NOTE: If rack mounting is not required, rubber feet are provided for tabletop mounting or stacking. Apply the feet near the corner edges on the underside of the unit.

NOTE: Reliable earthing of rack-mounted equipment should be maintained. Particular attention should be given to supply connections other than direct connections to the branch circuit (e.g. use of power strips).

To install the ears:

1. There are screws that secure each side of the DM-MD6X1 top cover. Using a #1 or #2 Phillips screwdriver, remove the three screws closest to the front panel from one side of the unit. Refer to the diagram following step 3 for a detailed view.
2. Position a rack ear so that its mounting holes align with the holes vacated by the screws in step 1.
3. Secure the ear to the unit with three screws from step 1, as shown in the following diagram.

Ear Attachment for Rack Mounting (this image shows a 1RU device)

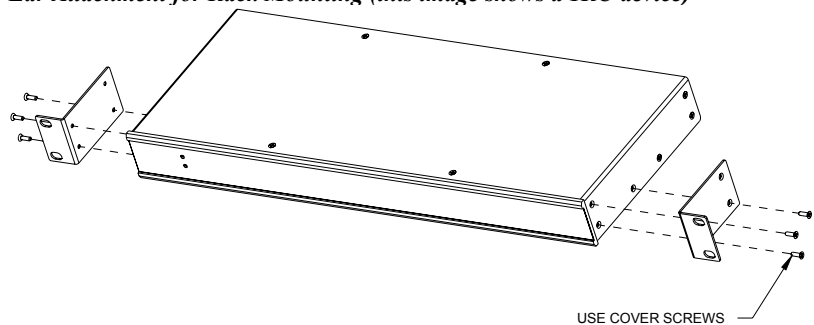

4. Repeat procedure (steps 1 through 3) to attach the remaining ear to the opposite side.

Stacking

Four “feet” are provided with the DM-MD6X1 so that if the unit is not rack mounted, the rubber feet can provide stability when the unit is placed on a flat surface or stacked. These feet should be attached prior to the hookup procedure. Refer to the following illustration for placement of the feet.

Foot Placement for the DM-MD6X1

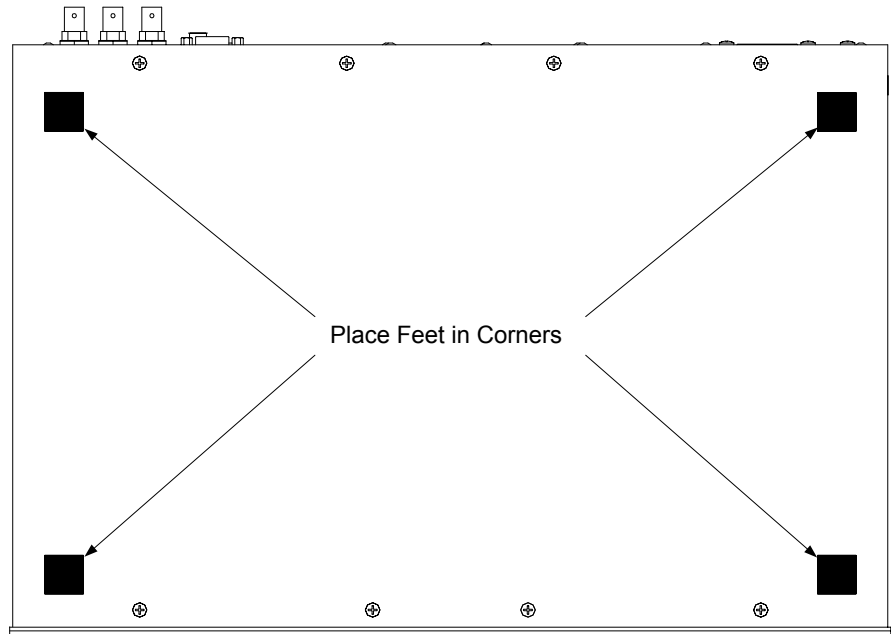

NOTE: No more than two DM-MD6X1 units should be stacked.

Hardware Hookup

Connect the Device

Make the necessary connections as called out in the illustration that follows this paragraph. Refer to “Network Wiring” on page 16 before applying power. Apply power after all connections have been made.

When making connections to the DM-MD6X1, note the following:

- Use Crestron power supplies for Crestron equipment.
- The included cable cannot be extended.

Hardware Connections for the DM-MD6X1 (Front View)

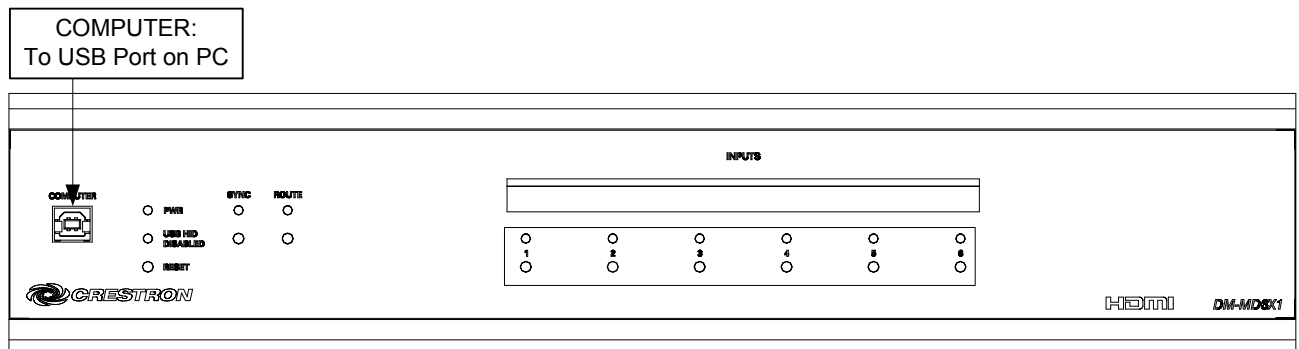

Hardware Connections for the DM-MD6X1 (Rear View)

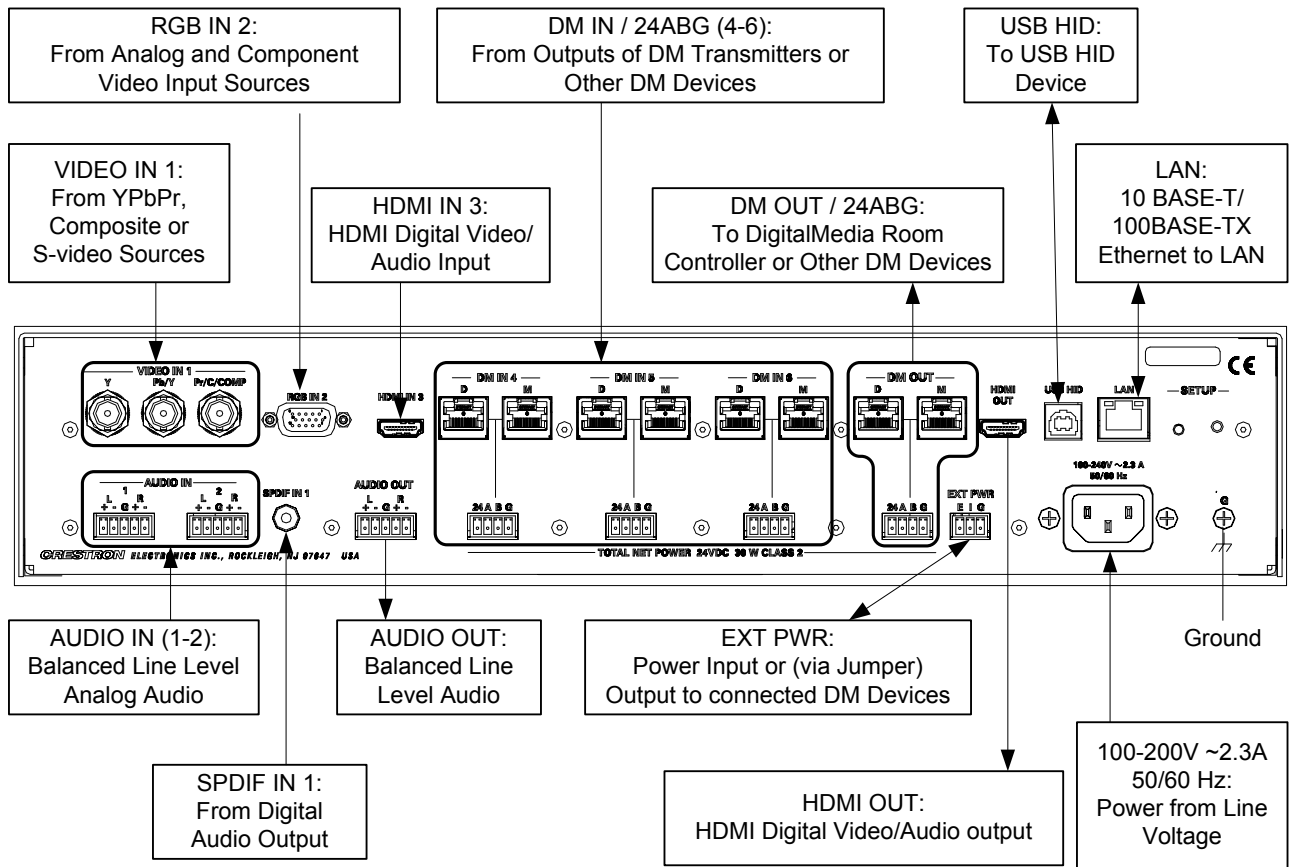

NOTE: If a DM Switcher, or other DM device supplying power, is connected to a **DM IN 4-6** port of the DM-MD6X1, then the **+24V** wire between the DM device and the DM-MD6X1 must be disconnected. The **A B G** wires must remain connected.

NOTE: Ensure the unit is properly grounded by connecting the chassis ground lug to an earth ground (building steel).

NOTE: To prevent overheating, do not operate this product in an area that exceeds the environmental temperature range listed in the table of specifications.

NOTE: For DigitalMedia CAT wiring, use DM-CBL DigitalMedia Cable. Up to two DM Repeaters (model DM-DR, supplied separately) may be required. Refer to the Crestron DigitalMedia Design Guide (Doc. 4789) for complete wiring guidelines.

NOTE: For optimum performance, Crestron requires using DM-CBL DigitalMedia cable, available from Crestron.

NOTE: The minimum cable length required for DM-CBL DigitalMedia cable is 15 feet (~4.6 meters).

DMNet Power

Devices connected to each DMNet port can receive power from the DM switcher's internal power supply or from an external power supply such as the C2N-SPWS300 (sold separately).

The DMNet ports are preconfigured for operation using the DM switcher's internal power supply.

To power the DMNet ports externally from a Cresnet 24 VDC power supply, connect the power supply to the **E** (External) and **G** (Ground) pins on the **EIG** connector as shown in the following diagram.

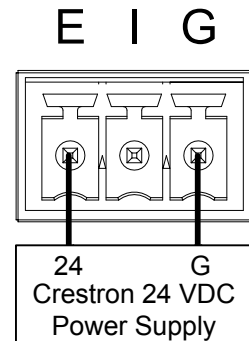
Providing DMNet Power Externally

To power the DMNet ports using the DM switcher's internal power supply, install the included jumper on the **EIG** connector from the **E** (External) pin to the **I** (Internal) pin as shown in the following diagram.

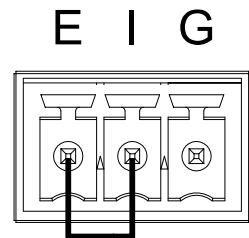
Providing DMNet Power Internally**Audio Connections**

Three balanced/unbalanced audio inputs/output are provided, utilizing five-pin terminal block connectors. For connection details, refer to the following table and diagrams.

Audio Connections

SIGNAL NAME	BALANCED AUDIO INPUT	BALANCED AUDIO OUTPUT	UNBALANCED AUDIO INPUT	UNBALANCED AUDIO OUTPUT
+	1 +	1 +	1 + In	1 + Out
-	1 -	1 -	1 – signal return, jumper to GND	Open
G	Shield/Ground	Shield/Ground	Ground	Common ground
+	2 +	2 +	2 + In	2 + Out
-	2 -	2 -	2 – signal return jumper to GND	Open

Typical Balanced/Unbalanced Outputs

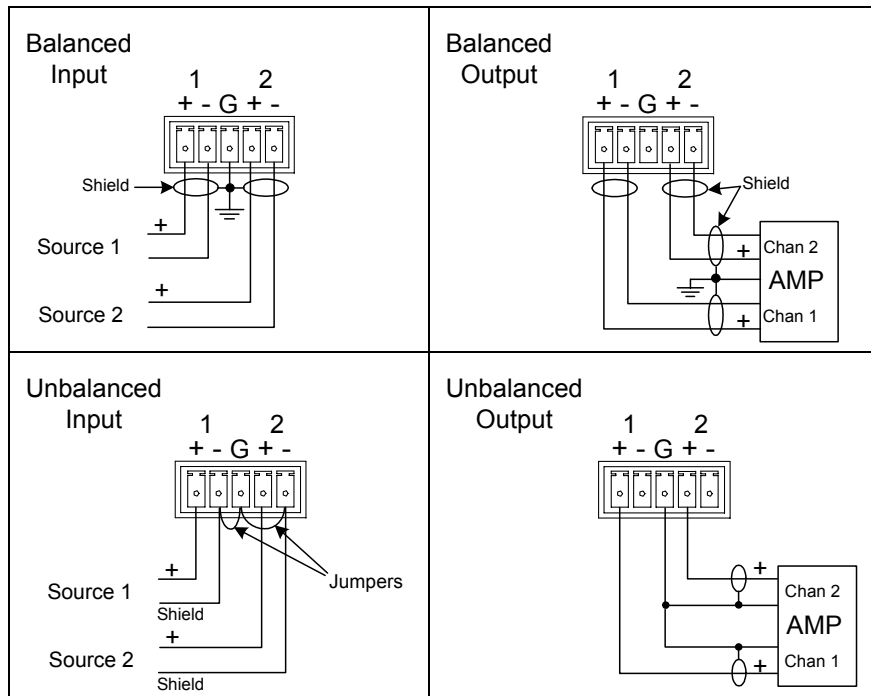

Label the Buttons

Use Crestron Engraver software to print custom labels for the DM-MD6X1's front panel buttons and LEDs. Crestron recommends printing on 100-pound paper. Paper weighing less than 100 pounds will tend to crumple while sliding in, while paper weighing more than 100 pounds may not fit.

Programming Software

Have a question or comment about Crestron software?

Answers to frequently asked questions (FAQs) can be viewed in the Online Help section of the Crestron Web site. To post a question or view questions you have submitted to Crestron's True Blue Support, log in at www.crestron.com/support. First-time users will need to establish a user account.

Earliest Version Software Requirements for the PC

NOTE: Crestron recommends that you use the latest software to take advantage of the most recently released features. The latest software is available from the Crestron Web site (www.crestron.com/software).

Crestron provides an assortment of Windows®-based software tools to develop a customized system. Use Crestron SystemBuilder™ or SIMPL Windows to create a program to control the DM-MD6X1

Programming with Crestron SystemBuilder

Crestron SystemBuilder is the easiest method of programming but does not offer as much flexibility as SIMPL Windows. For additional details, download SystemBuilder from the Crestron Web site and examine the extensive help file.

Programming with SIMPL Windows

NOTE: While SIMPL Windows can be used to program the DM-MD6X1, it is recommended to use SystemBuilder and DigitalMedia Tools™ software for configuring a system.

SIMPL Windows is Crestron's premier software for programming Crestron control systems. It is organized into two separate but equally important "Managers": Configuration and Program.

Configuration Manager

Configuration Manager is the view where programmers "build" a Crestron control system by selecting hardware from the *Device Library*.

1. To incorporate the DM-MD6X1 into the system, drag the DM-MD6X1 from the DigitalMedia | DM Midpoints folder of the *Device Library* and drop it in the *System Views*.

Locating the DM-MD6X1 in the Device Library



The system tree of the control system displays the device in the appropriate slot with a default or IP ID as shown in the following illustration.

C2ENET-1 Device, Slot 8

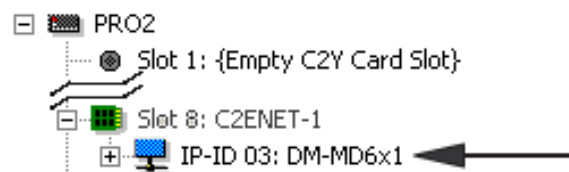

2. If additional DM-MD6X1 devices are to be added, repeat step 1 for each device. Each DM-MD6X1 is assigned a different IP ID number as it is added.
3. If necessary, double click a device to open the “Device Settings” window and change the IP ID as shown in the following illustration.

“Device Settings: Crestron DM-MD6X1” Window

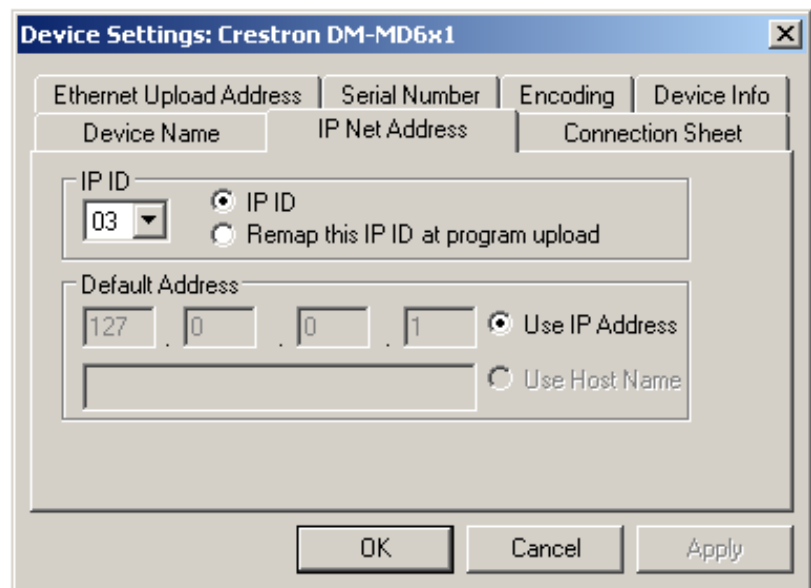

NOTE: The ID code specified in the SIMPL Windows program must match the IP ID of each unit. Refer to “Identity Code” on page 18.

IP Table Options

DigitalMedia devices like the DM-RMC-100 (sold separately) that receive their IP address configuration via the switcher can also receive their IP table configuration

from the DM switcher or have their IP table manually configured. Depending on the application, add DM devices as described below:

- Scenario 1: Control Center with Control System, DM switcher and DM-RMC-100 Room Controller; Automatic IP Table Configuration.

***Control Center Containing Control System,
DM-MD6X1 and DM-RMC-100 Room Controller***

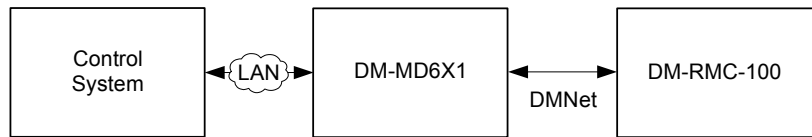

To configure a SIMPL Windows program for this layout, drop a DM-TX-100, DM-TX-200, DM-RMC-100 or DM-RMC-200 (as appropriate, all sold separately) onto the slots that are on the DM-MD6X1 as shown in the illustration below. The IP table of each device will be automatically configured and uploaded.

***Automatic IP Configuration of DM-MD6X1
with Devices Placed on DMS-CAT-HD and DM-HDMI Outputs***

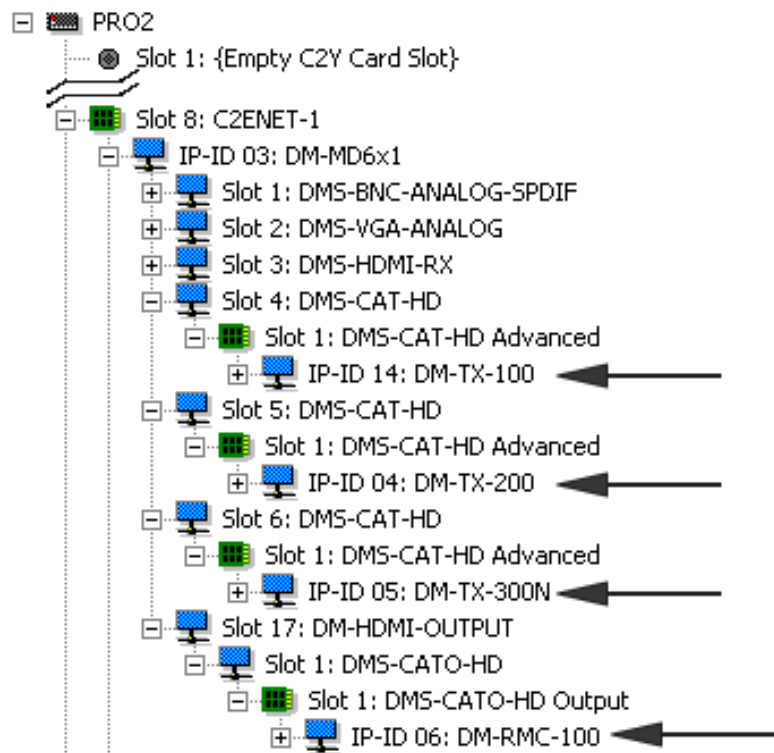

- Scenario 2: Control Center with Control System and DM-MD6X1, DM-RMC-100 Room Controller and DM-TX-100 Transmitter (all sold separately); Manual IP Table Configuration.

To configure a SIMPL Windows program for this layout, drop DM-RMC-100 and DM-TX-100 devices onto the control system's Ethernet slot. The IP table of each DM-RMC-100 will require manual configuration. Refer to the following illustration.

*Manual IP Configuration of DM-RMC-100 and DM-TX-100
with Devices Placed on Ethernet Port on Control System*

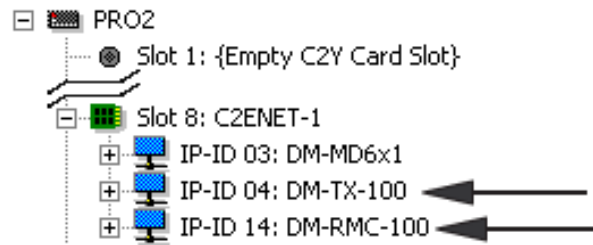

Program Manager

Program Manager is the view where programmers “program” a Crestron control system by assigning signals to symbols.

The symbol can be viewed by double clicking on the icon or dragging it into *Detail View*. Each signal in the symbol is described in the SIMPL Windows help file (**F1**).

Uploading and Upgrading

Crestron recommends using the latest programming software and that each device contains the latest firmware to take advantage of the most recently released features. However, before attempting to upload or upgrade it is necessary to establish communication. Once communication has been established, files (for example, firmware) can be transferred to the control system (and/or device). In addition, the IP table of the device can be configured.

Establishing Communication

Use Crestron Toolbox for communicating with the DM-MD6X1; refer to the Crestron Toolbox help file for details.

A PC running Crestron Toolbox communicates with the DM-MD6X1 in the following ways:

- Via USB communication.
- Via the LAN port of the DM-MD6X1 using TCP/IP communication. In this scenario, the DM-MD6X1 is used in a standalone configuration (i.e., a DM switcher is not used). TCP/IP provides a faster method of communication than USB.

Via USB Port

USB Communication

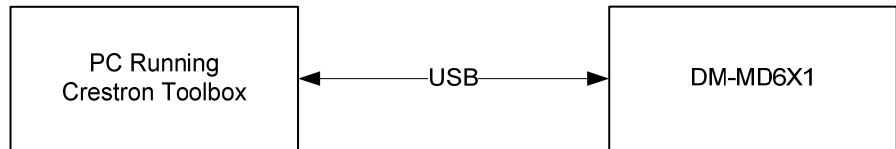

To establish USB communication between the PC and the DM-MD6X1 via a DM switcher:

1. Use the Address Book in Crestron Toolbox to create an entry using the expected communication protocol (USB). When multiple USB devices are connected, identify the DM-MD6X1 by entering “DM-MD6X1” in the *Model* textbox, the unit’s serial number in the *Serial* textbox or the unit’s hostname in the *Hostname* textbox. The hostname can be found in the “System Info” window in the section marked *Ethernet* however, communications must be established in order to see this information in the “System Info” window.
2. Display the DM-MD6X1’s “System Info” window (click the  icon); communications are confirmed when the device information is displayed.

Via LAN Port

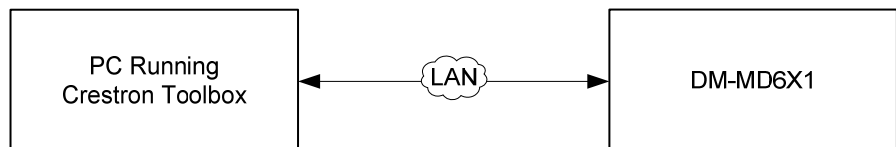

TCP/IP Communication via LAN Port of DM-MD6X1



To establish TCP/IP communication between the PC and the DM-MD6X1 via the LAN port of the DM-MD6X1:

1. Use the Device Discovery Tool in Crestron Toolbox to find the IP address of the DM-MD6X1. The tool is available in Toolbox version 1.15.143 or later.

NOTE: When the DM-MD6X1 is used in a standalone configuration (i.e., without a DM switcher), DHCP is enabled by default. If desired, a default IP address (192.168.1.244) can be assigned by holding down its **SETUP** button while applying power. This IP address overwrites any previous settings and remains until it is changed manually.

2. Use the Address Book in Crestron Toolbox to create an entry for the DM-MD6X1 using the *TCP* connection type and enter the IP address of the DM-MD6X1.
3. Display the DM-MD6X1's "System Info" window (click the  icon); communications are confirmed when the device information is displayed.
4. (Optional) If additional changes to TCP/IP settings are desired, do the following:
 - a. Assign an IP address, IP mask and default router for the DM-MD6X1 via Crestron Toolbox (**Functions | Ethernet Addressing**).
 - b. Close the "System Info" window.
 - c. In Crestron Toolbox, change the Address Book entry for the DM-MD6X1 so that it uses the IP address assigned in step 4a.
 - d. Display the DM-MD6X1's "System Info" window (click the  icon); communications are confirmed when the device information is displayed.

Programs and Firmware

Program or firmware files may be distributed from programmers to installers or from Crestron to dealers. Firmware upgrades are available from the Crestron Web site as new features are developed after product releases. One has the option to upload programs via the programming software or to upload and upgrade via the Crestron Toolbox. For details on uploading and upgrading, refer to the SIMPL Windows help file or the Crestron Toolbox help file.

SIMPL Windows

If a SIMPL Windows program is provided, it can be uploaded to the control system using SIMPL Windows or Crestron Toolbox.

Firmware

Check the Crestron Web site (www.crestron.com/firmware) to find the latest firmware. (New users may be required to register to obtain access to certain areas of the site, including the FTP site.) To upload firmware to the DM-MD6X1, the Package Update Tool must be used. Refer to the Toolbox help file for details.

Upgrade DM-MD6X1 firmware via the Package Update Tool in Crestron Toolbox.

1. Establish communication with the DM-MD6X1 and display the "System Info" window.
2. Select **Tools | Package Update Tool ...** to upgrade the DM-MD6X1 firmware or double click on an appropriate Package Update File (PUF) located on your hard drive. This will load the Package Update Tool as a standalone application. Refer to the Toolbox help file for details.

Program Checks

Actions that can be performed on the DM-MD6X1 vary depending on whether it is connected via USB, DMNet or Ethernet.

USB Connections

For USB connections, using Crestron Toolbox, display the “System Info” window (click the **i** icon) and select the **Functions** menu to display actions that can be performed on the DM switcher.

DMNet Connections

For DMNet connections, using Crestron Toolbox, display the network device tree (**Tools | Network Device Tree View**) to show all network devices connected to the control system. Right-click on the DM-MD6X1 to display actions that can be performed on the DM-MD6X1.

Ethernet Connections

For Ethernet connections, using Crestron Toolbox, display the “System Info” window (click the **i** icon) and select the **Functions** menu to display actions that can be performed on the DM-MD6X1.

Be sure to use Crestron Toolbox to create the DM-MD6X1 IP table.

1. Select **Functions | IP Table Setup**.
2. Add, modify or delete entries in the IP table. The DM-MD6X1 can have only one IP table entry.
3. A defined IP table can be saved to a file or sent to the device.

Edit the control system’s IP table to include an entry for the DM-MD6X1. The entry should list the DM-MD6X1’s IP ID (specified on the DM-MD6X1’s IP table) and the internal gateway IP address 127.0.0.1.

DMTool

In the Crestron Toolbox Address Book, select the DM-MD6X1. Then use the DMTool to configure EDID, HDCP or to troubleshoot AV on the DM-MD6X1. Refer to the help file for additional information.

DMTool

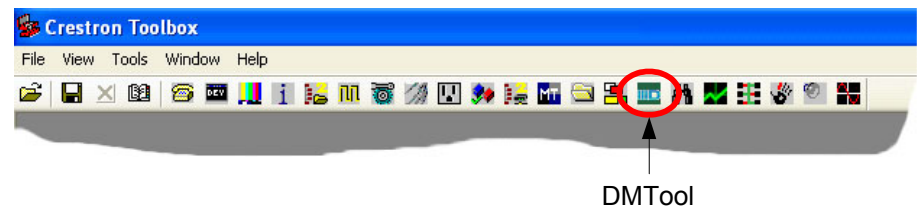

Operation

The DM-MD6X1 operates in *Sync* mode and *Route* mode by using the front panel buttons.

Sync Mode

Pressing the **SYNC** button on the front panel will light the LEDs for inputs where the same signal type is present.

Route Mode

Pressing the **ROUTE** button on the front panel will allow you to make input routing changes by pressing the desired input button(s).

NOTE: When the signal type on **RGB IN 2** is RGB, switching to this input can take eight to ten seconds because the DM-MD6X1 must autocalibrate the RGB input signal. If the signal type on **RGB IN 2** is composite, S-video or component, switching will take the normal three to five seconds.

Problem Solving

The following table provides corrective action for possible trouble situations. If further assistance is required, please contact a Crestron customer service representative.

DM-MD6X1 Troubleshooting

TROUBLE	POSSIBLE CAUSE(S)	CORRECTIVE ACTION
Incorrect audio or video displayed.	Audio is routed separately from video.	Reroute audio together with video.
Distorted audio or video.	Source does not match capabilities of destination.	Use Crestron Toolbox to manage EDID capabilities of devices in the system.
No video displayed, but audio is heard.	Possible HDCP error.	Check control system error log, or DM switch for HDCP errors.
HDCP Check Failure Message during commissioning.	Violation of HDCP rules (number of display devices exceeds the source's number of allowed displays).	Disconnect displays that may not be used with source during run time and repeat HDCP check.
	Violation of HDCP rules (device depth exceeds allowable depth specification).	Replace source device with a device that allows more displays to be connected.
		Reconfigure signal path to remove midpoint devices that increase overall device depth.
Device does not function.	Device is not communicating with the network.	Use Crestron Toolbox to poll the network. Verify network connection to the device.
	Electrostatic discharge due to improper grounding.	Check that all ground connections have been made properly.
Unexpected operation.	Device is receiving power from another powered DM device (switch or endpoint).	Disconnect the +24V wire between the DM-MD6X1 and the other powered device.
Loss of video.	Various causes.	Use DM Tool to determine cause and correct accordingly.

NOTE: For more advanced diagnostics, use the DMTool in Crestron Toolbox.

Check Network Wiring

Use the Right Wire

To ensure optimum performance over the full range of your installation topology, use Crestron Certified Wire only. Failure to do so may incur additional charges if support is required to identify performance deficiencies because of using improper wire.

Calculate Power

CAUTION: Use only Crestron power supplies for Crestron equipment. Failure to do so could cause equipment damage or void the Crestron warranty.

CAUTION: Provide sufficient power to the system. Insufficient power can lead to unpredictable results or damage to the equipment. The **EIG** connector on the DM switcher is used to bring in external power. Additional power is rarely required as switchers provide enough power for most typical configurations. Please use the DMNet Power Calculator to help calculate how much power is needed for the system (www.crestron.com/calculators).

Refer to the following table for commonly used resolutions and maximum DM-CBL cable lengths.

Commonly Used Resolutions and Maximum DM Cable Length

RESOLUTION	DM-CBL CABLE LENGTH	
	Maximum length without, between, before or after repeaters	Maximum total length using up to 2 repeaters
720p, 1080i, 1080p24	200 ft (60 m)	450 ft (137 m)
1024 x 768 @ 75 Hz	200 ft (60 m)	450 ft (137 m)
1080p60	150 ft (45 m)	450 ft (137 m)
1280 x 1024 @ 75 Hz	150 ft (45 m)	450 ft (137 m)
1920 x 1200 @ 60 Hz	150 ft (45 m)	450 ft (137 m)
1600 x 1200 @ 60 Hz	125 ft (38 m)	375 ft (114 m)
1080p60 Deep Color	Not supported	

NOTE: 1080p60 is the most common resolution used in residential installations.

NOTE: All Crestron certified DMNet wiring must consist of two twisted pairs. One twisted pair is the +24V conductor and the GND conductor and the other twisted pair is the A conductor and the B conductor.

Reference Documents

The latest version of all documents mentioned within the guide can be obtained from the Crestron Web site.

List of Related Reference Documents

DOCUMENT TITLE
Crestron DigitalMedia Design Guide (www.crestron.com/dmresources)
Crestron e-Control Reference Guide (www.crestron.com/manuals)
Crestron IP Considerations Guide (www.crestron.com/dmresources)

Further Inquiries

If you cannot locate specific information or have questions after reviewing this guide, please take advantage of Crestron's award winning customer service team by calling Crestron at 1-888-CRESTRON [1-888-273-7876].

You can also log onto the online help section of the Crestron Web site (www.crestron.com/onlinehelp) to ask questions about Crestron products. First-time users will need to establish a user account to fully benefit from all available features.

Future Updates

As Crestron improves functions, adds new features and extends the capabilities of the DM-MD6X1, additional information may be made available as manual updates. These updates are solely electronic and serve as intermediary supplements prior to the release of a complete technical documentation revision.

Check the Crestron Web site periodically for manual update availability and its relevance. Updates are identified as an “Addendum” in the Download column.

Return and Warranty Policies

Merchandise Returns / Repair Service

1. No merchandise may be returned for credit, exchange or service without prior authorization from CRESTRON. To obtain warranty service for CRESTRON products, contact an authorized CRESTRON dealer. Only authorized CRESTRON dealers may contact the factory and request an RMA (Return Merchandise Authorization) number. Enclose a note specifying the nature of the problem, name and phone number of contact person, RMA number and return address.
2. Products may be returned for credit, exchange or service with a CRESTRON Return Merchandise Authorization (RMA) number. Authorized returns must be shipped freight prepaid to CRESTRON, 6 Volvo Drive, Rockleigh, N.J. or its authorized subsidiaries, with RMA number clearly marked on the outside of all cartons. Shipments arriving freight collect or without an RMA number shall be subject to refusal. CRESTRON reserves the right in its sole and absolute discretion to charge a 15% restocking fee plus shipping costs on any products returned with an RMA.
3. Return freight charges following repair of items under warranty shall be paid by CRESTRON, shipping by standard ground carrier. In the event repairs are found to be non-warranty, return freight costs shall be paid by the purchaser.

CRESTRON Limited Warranty

CRESTRON ELECTRONICS, Inc. warrants its products to be free from manufacturing defects in materials and workmanship under normal use for a period of three (3) years from the date of purchase from CRESTRON, with the following exceptions: disk drives and any other moving or rotating mechanical parts, pan/tilt heads and power supplies are covered for a period of one (1) year; touchscreen display and overlay components are covered for 90 days; batteries and incandescent lamps are not covered.

This warranty extends to products purchased directly from CRESTRON or an authorized CRESTRON dealer. Purchasers should inquire of the dealer regarding the nature and extent of the dealer's warranty, if any.

CRESTRON shall not be liable to honor the terms of this warranty if the product has been used in any application other than that for which it was intended or if it has been subjected to misuse, accidental damage, modification or improper installation procedures. Furthermore, this warranty does not cover any product that has had the serial number altered, defaced or removed.

This warranty shall be the sole and exclusive remedy to the original purchaser. In no event shall CRESTRON be liable for incidental or consequential damages of any kind (property or economic damages inclusive) arising from the sale or use of this equipment. CRESTRON is not liable for any claim made by a third party or made by the purchaser for a third party.

CRESTRON shall, at its option, repair or replace any product found defective, without charge for parts or labor. Repaired or replaced equipment and parts supplied under this warranty shall be covered only by the unexpired portion of the warranty.

Except as expressly set forth in this warranty, CRESTRON makes no other warranties, expressed or implied, nor authorizes any other party to offer any warranty, including any implied warranties of merchantability or fitness for a particular purpose. Any implied warranties that may be imposed by law are limited to the terms of this limited warranty. This warranty statement supersedes all previous warranties.

GNU General Public License

Version 2, June 1991

Copyright (C) 1989, 1991 Free Software Foundation, Inc., 51 Franklin Street, Fifth Floor, Boston, MA 02110-1301 USA
Everyone is permitted to copy and distribute verbatim copies of this license document but changing it is not allowed.

PREAMBLE

The licenses for most software are designed to take away your freedom to share and change it. By contrast, the GNU General Public License is intended to guarantee your freedom to share and change free software--to make sure the software is free for all its users. This General Public License applies to most of the Free Software Foundation's software and to any other program whose authors commit to using it. (Some other Free Software Foundation software is covered by the GNU Lesser General Public License instead.) You can apply it to your programs too.

When we speak of free software, we are referring to freedom, not price. Our General Public Licenses are designed to make sure that you have the freedom to distribute copies of free software (and charge for this service if you wish), that you receive source code or can get it if you want it, that you can change the software or use pieces of it in new free programs and that you know you can do these things.

To protect your rights, we need to make restrictions that forbid anyone to deny you these rights or to ask you to surrender the rights. These restrictions translate to certain responsibilities for you if you distribute copies of the software or if you modify it.

For example, if you distribute copies of such a program, whether gratis or for a fee, you must give the recipients all the rights that you have. You must make sure that they too receive or can get the source code. And you must show them these terms so they know their rights.

We protect your rights with two steps: (1) copyright the software, and (2) offer you this license which gives you legal permission to copy, distribute and/or modify the software.

Also, for each author's protection and ours, we want to make certain that everyone understands that there is no warranty for this free software. If the software is modified by someone else and passed on, we want its recipients to know that what they have is not the original, so that any problems introduced by others will not reflect on the original authors' reputations.

Finally, any free program is threatened constantly by software patents. We wish to avoid the danger that redistributors of a free program will individually obtain patent licenses, in effect making the program proprietary. To prevent this, we have made it clear that any patent must be licensed for everyone's free use or not licensed at all.

The precise terms and conditions for copying, distribution and modification follow.

GNU GENERAL PUBLIC LICENSE TERMS AND CONDITIONS FOR COPYING, DISTRIBUTION AND MODIFICATION

0. This License applies to any program or other work which contains a notice placed by the copyright holder saying it may be distributed under the terms of this General Public License. The "Program" below refers to any such program or work, and a "work based on the Program" means either the Program or any derivative work under copyright law: that is to say, a work containing the Program or a portion of it, either verbatim or with modifications and/or translated into another language. (Hereinafter, translation is included without limitation in the term "modification".) Each licensee is addressed as "you".

Activities other than copying, distribution and modification are not covered by this License; they are outside its scope. The act of running the Program is not restricted, and the output from the Program is covered only if its contents constitute a work based on the Program (independent of having been made by running the Program). Whether that is true depends on what the Program does.

1. You may copy and distribute verbatim copies of the Program's source code as you receive it, in any medium, provided that you conspicuously and appropriately publish on each copy an appropriate copyright notice and disclaimer of warranty; keep intact all the notices that refer to this License and to the absence of any warranty; and give any other recipients of the Program a copy of this License along with the Program.

You may charge a fee for the physical act of transferring a copy and you may at your option offer warranty protection in exchange for a fee.

2. You may modify your copy or copies of the Program or any portion of it, thus forming a work based on the Program, and copy and distribute such modifications or work under the terms of Section 1 above, provided that you also meet all of these conditions:

- a) You must cause the modified files to carry prominent notices stating that you changed the files and the date of any change.
- b) You must cause any work that you distribute or publish, that in whole or in part contains or is derived from the Program or any part thereof, to be licensed as a whole at no charge to all third parties under the terms of this License.
- c) If the modified program normally reads commands interactively when run, you must cause it, when started running for such interactive use in the most ordinary way, to print or display an announcement including an appropriate copyright notice and a notice that there is no warranty (or else, saying that you provide a warranty) and that users may redistribute the program under these conditions, and telling the user how to view a copy of this License. (Exception: if the Program itself is interactive but does not normally print such an announcement, your work based on the Program is not required to print an announcement.)

These requirements apply to the modified work as a whole. If identifiable sections of that work are not derived from the Program and can be reasonably considered independent and separate works in themselves, then this License and its terms do not apply to those sections when you distribute them as separate works. But when you distribute the same sections as part of a whole which is a work based on the Program, the distribution of the whole must be on the terms of this License, whose permissions for other licensees extend to the entire whole and thus to each and every part regardless of who wrote it.

Thus, it is not the intent of this section to claim rights or contest your rights to work written entirely by you; rather, the intent is to exercise the right to control the distribution of derivative or collective works based on the Program.

In addition, mere aggregation of another work not based on the Program with the Program (or with a work based on the Program) on a volume of a storage or distribution medium does not bring the other work under the scope of this License.

3. You may copy and distribute the Program (or a work based on it, under Section 2) in object code or executable form under the terms of Sections 1 and 2 above provided that you also do one of the following:

- a) Accompany it with the complete corresponding machine-readable source code, which must be distributed under the terms of Sections 1 and 2 above on a medium customarily used for software interchange; or,
- b) Accompany it with a written offer, valid for at least three years, to give any third party, for a charge no more than your cost of physically performing source distribution, a complete machine-readable copy of the corresponding source code, to be distributed under the terms of Sections 1 and 2 above on a medium customarily used for software interchange; or,
- c) Accompany it with the information you received as to the offer to distribute corresponding source code. (This alternative is allowed only for noncommercial distribution and only if you received the program in object code or executable form with such an offer, in accord with Subsection b above.)

The source code for a work means the preferred form of the work for making modifications to it. For an executable work, complete source code means all the source code for all modules it contains, plus any associated interface definition files, plus the scripts used to control compilation and installation of the executable. However, as a special exception, the source code distributed need not include anything that is normally distributed (in either source or binary form) with the major components (compiler, kernel and so on) of the operating system on which the executable runs, unless that component itself accompanies the executable.

If distribution of executable or object code is made by offering access to copy from a designated place, then offering equivalent access to copy the source code from the same place counts as distribution of the source code, even though third parties are not compelled to copy the source along with the object code.

4. You may not copy, modify, sublicense or distribute the Program except as expressly provided under this License. Any attempt otherwise to copy, modify, sublicense or distribute the Program is void and will automatically terminate your rights under this License. However, parties who have received copies or rights, from you under this License will not have their licenses terminated so long as such parties remain in full compliance.

5. You are not required to accept this License, since you have not signed it. However, nothing else grants you permission to modify or distribute the Program or its derivative works. These actions are prohibited by law if you do not accept this License. Therefore, by

modifying or distributing the Program (or any work based on the Program), you indicate your acceptance of this License to do so and all its terms and conditions for copying, distributing or modifying the Program or works based on it.

6. Each time you redistribute the Program (or any work based on the Program), the recipient automatically receives a license from the original licensor to copy, distribute or modify the Program subject to these terms and conditions. You may not impose any further restrictions on the recipients' exercise of the rights granted herein. You are not responsible for enforcing compliance by third parties to this License.

7. If, as a consequence of a court judgment or allegation of patent infringement or for any other reason (not limited to patent issues), conditions are imposed on you (whether by court order, agreement or otherwise) that contradict the conditions of this License, they do not excuse you from the conditions of this License. If you cannot distribute so as to satisfy simultaneously your obligations under this License and any other pertinent obligations, then as a consequence you may not distribute the Program at all. For example, if a patent license would not permit royalty-free redistribution of the Program by all those who receive copies directly or indirectly through you, then the only way you could satisfy both it and this License would be to refrain entirely from distribution of the Program.

If any portion of this section is held invalid or unenforceable under any particular circumstance, the balance of the section is intended to apply and the section as a whole is intended to apply in other circumstances.

It is not the purpose of this section to induce you to infringe any patents or other property right claims or to contest validity of any such claims; this section has the sole purpose of protecting the integrity of the free software distribution system, which is implemented by public license practices. Many people have made generous contributions to the wide range of software distributed through that system in reliance on consistent application of that system; it is up to the author/donor to decide if he or she is willing to distribute software through any other system and a licensee cannot impose that choice.

This section is intended to make thoroughly clear what is believed to be a consequence of the rest of this License.

8. If the distribution and/or use of the Program is restricted in certain countries either by patents or by copyrighted interfaces, the original copyright holder who places the Program under this License may add an explicit geographical distribution limitation excluding those countries, so that distribution is permitted only in or among countries not thus excluded. In such case, this License incorporates the limitation as if written in the body of this License.

9. The Free Software Foundation may publish revised and/or new versions of the General Public License from time to time. Such new versions will be similar in spirit to the present version but may differ in detail to address new problems or concerns.

Each version is given a distinguishing version number. If the Program specifies a version number of this License which applies to it and "any later version", you have the option of following the terms and conditions either of that version or of any later version published by the Free Software Foundation. If the Program does not specify a version number of this License, you may choose any version ever published by the Free Software Foundation.

10. If you wish to incorporate parts of the Program into other free programs whose distribution conditions are different, write to the author to ask for permission. For software which is copyrighted by the Free Software Foundation, write to the Free Software Foundation; we sometimes make exceptions for this. Our decision will be guided by the two goals of preserving the free status of all derivatives of our free software and of promoting the sharing and reuse of software generally.

NO WARRANTY

11. BECAUSE THE PROGRAM IS LICENSED FREE OF CHARGE, THERE IS NO WARRANTY FOR THE PROGRAM, TO THE EXTENT PERMITTED BY APPLICABLE LAW. EXCEPT WHEN OTHERWISE STATED IN WRITING THE COPYRIGHT HOLDERS AND/OR OTHER PARTIES PROVIDE THE PROGRAM "AS IS" WITHOUT WARRANTY OF ANY KIND, EITHER EXPRESSED OR IMPLIED, INCLUDING BUT NOT LIMITED TO, THE IMPLIED WARRANTIES OF MERCHANTABILITY AND FITNESS FOR A PARTICULAR PURPOSE. THE ENTIRE RISK AS TO THE QUALITY AND PERFORMANCE OF THE PROGRAM IS WITH YOU. SHOULD THE PROGRAM PROVE DEFECTIVE, YOU ASSUME THE COST OF ALL NECESSARY SERVICING, REPAIR OR CORRECTION.

12. IN NO EVENT UNLESS REQUIRED BY APPLICABLE LAW OR AGREED TO IN WRITING WILL ANY COPYRIGHT HOLDER OR ANY OTHER PARTY WHO MAY MODIFY AND/OR REDISTRIBUTE THE PROGRAM AS PERMITTED ABOVE, BE LIABLE TO YOU FOR DAMAGES, INCLUDING ANY GENERAL, SPECIAL, INCIDENTAL OR CONSEQUENTIAL DAMAGES ARISING OUT OF THE USE OR INABILITY TO USE THE PROGRAM (INCLUDING BUT NOT LIMITED TO LOSS OF DATA OR DATA BEING RENDERED INACCURATE OR LOSSES SUSTAINED BY YOU OR THIRD PARTIES OR A FAILURE OF THE PROGRAM TO OPERATE WITH ANY OTHER PROGRAMS), EVEN IF SUCH HOLDER OR OTHER PARTY HAS BEEN ADVISED OF THE POSSIBILITY OF SUCH DAMAGES.

This page is intentionally left blank.



Crestron Electronics, Inc.
15 Volvo Drive Rockleigh, NJ 07647
Tel: 888.CRESTRON
Fax: 201.767.7576
www.crestron.com

Operations Guide – DOC. 6850D
(2024730)
02.11
Specifications subject to
change without notice.