

Crestron **TPS-6L**
Isys® 5.7" Wall Mount Touchpanel
Operations & Installation Guide



This document was prepared and written by the Technical Documentation department at:



Crestron Electronics, Inc.

15 Volvo Drive

Rockleigh, NJ 07647

1-888-CRESTRON

Contents

Isys® 5.7" Wall Mount Touchpanel: TPS-6L	1
Introduction	1
Features and Functions.....	1
Applications	3
Internal Block Diagram	4
Specifications.....	4
Physical Description.....	7
Industry Compliance	11
Setup.....	12
Network Wiring	12
Identity Code.....	12
Configuring the Touchpanel.....	13
Mounting Options	29
Touchpanel Mounting	30
Touchpanel Removal	34
Hardware Hookup	34
Recommended Cleaning	35
Programming Software.....	36
Earliest Version Software Requirements for the PC	36
Programming with Crestron SystemBuilder	36
Programming with D3 Pro	36
Programming with SIMPL Windows.....	36
Programming with VisionTools Pro-e	39
Example Program.....	42
Uploading and Upgrading	43
Establishing Communication	43
Programs, Projects and Firmware	44
Program Checks	44
Problem Solving.....	45
Troubleshooting	45
Check Network Wiring	46
Reference Documents	47
Further Inquiries.....	47
Future Updates	47
Software License Agreement.....	48
Return and Warranty Policies.....	50
Merchandise Returns / Repair Service	50
CRESTRON Limited Warranty	50

Isys® 5.7" Wall Mount Touchpanel: TPS-6L

Introduction

Features and Functions

This guide describes multiple models; differences are noted where applicable.

- 5.7" active matrix color touchscreen display
- 16-bit Isys® graphics | 640 x 480 resolution
- Synapse™ image rendering algorithm
- Single full motion, fully scalable video window
- Amplified speaker (optional) and microphone
- Includes faceplate with 12 "hard key" pushbuttons
- Button engraving available as solid or backlit text
- No-button blank faceplate also provided
- WAV file audio feedback
- Built-in light sensor
- Crestron Home® CAT5 AV connectivity
- High speed Ethernet and Cresnet® communications
- Wall, lectern and rack mounting options
- Available in almond, black or white

The Isys® TPS-6L Wall Mount Touchpanel delivers high end style and performance in a compact, cost effective flush mount design. Featuring a bright, beautiful, high-contrast 5.7" color touchscreen with 16-bit Isys graphics, 640 x 480 resolution and single video window display, the TPS-6L delivers a world of control capability yet leaves a very small footprint. The addition of 12 optional pushbuttons provides quick access to commonly used functions.

Crestron® touchpanels offer an ideal user interface for controlling everything from basic audio distribution and lighting to complete home automation and multimedia presentation, providing a wide open canvas for the creation of custom control screens perfectly tailored to the needs of the end user. Touchpanels do away with piles of remote controls, cryptic front panels and cluttered wall switches, affording true "one touch" control over a broad range of complex devices and systems.

Isys[®]

Isys power and beauty are infused throughout Crestron's entire touchpanel lineup. Under the hood, the Isys engine combines a 32-bit Freescale ColdFire[®] microprocessor with an ingenious and ultra efficient operating system to produce astonishing full color graphics and high res images with lightning fast performance. Capabilities include dynamic graphics and text, full motion animations, multimode objects and PNG translucency.

Synapse[™]

Crestron's exclusive Synapse Image Rendering Algorithm enables system programmers to produce amazing graphics - faster and easier. Advanced antialiasing delivers crisper, sharper objects and text. Enhanced 3D effects add new depth and style. And because Synapse is native to the touchpanel, memory requirements and upload time are substantially reduced.

Full Motion Video

The TPS-6L can display full motion video from an external source, providing an exceptional utility for viewing security cameras and other video signals on the touchscreen display. The video image is fully scalable for viewing in any sized window or full screen. The choice of balanced or unbalanced composite inputs allows compatibility with both conventional coaxial and Crestron Home[®] Balanced AV distribution systems.

Audio Features

Customized WAV audio files can be loaded on the touchpanel to add dimension to its touchscreen graphics using personalized sounds, button feedback and voice prompts. An external speaker option can be added for amplification of external AV sources and to support programmable intercom functionality in combination with the built-in microphone.

Crestron Home[®] CAT5 AV

The TPS-6L is ideal for use with AV distribution and intercom systems of all sizes. Its balanced audio and video connections make installation easy and affordable using inexpensive CAT5 type wire and Crestron's popular CH CAT5 Balanced AV distribution switchers. A single balanced video input accepts signals from composite video sources over wiring distances of up to 750 feet, while balanced audio connections are included to accept incoming stereo program audio and intercom signals and to output audio from the internal microphone. Connection to conventional coaxial video and audio systems is also supported.

Pushbutton Options

The TPS-6L features a faceplate (bezel) containing 12 programmable "hard key" pushbuttons, elegantly trimmed by illuminated button dividers. Integral to the faceplate, the pushbuttons are positioned along the left and right edges of the touchscreen, making it possible to align dynamically changing text and graphics on screen beside the pushbuttons to support context sensitive menu functions such as digital media titles, channels or lighting presets. Custom engraving of the buttons is available, with a choice of solid or backlit text. A plain, no-button faceplate is also included, allowing a very clean appearance with no pushbuttons.

Light Sensor

A light sensor is built into the TPS-6L to automatically adjust the display brightness for optimal visibility under varying light conditions.

High Speed Connectivity

Both Cresnet® and high speed Ethernet are standard on the TPS-6L, providing for easy network integration and seamless communications with Crestron control systems.

Versatile Flush Mount Design

The TPS-6L is designed for easy flush mount installation in a wall, lectern or similar flat surface. Mounting clips furnished with the TPS-6L facilitate a clean installation in drywall and many furniture applications. Additional mounting options are available separately including optional back box and 19" rack mount kit.

Applications

The following diagram shows a TPS-6L in a basic AV application.

TPS-6L Application Diagram

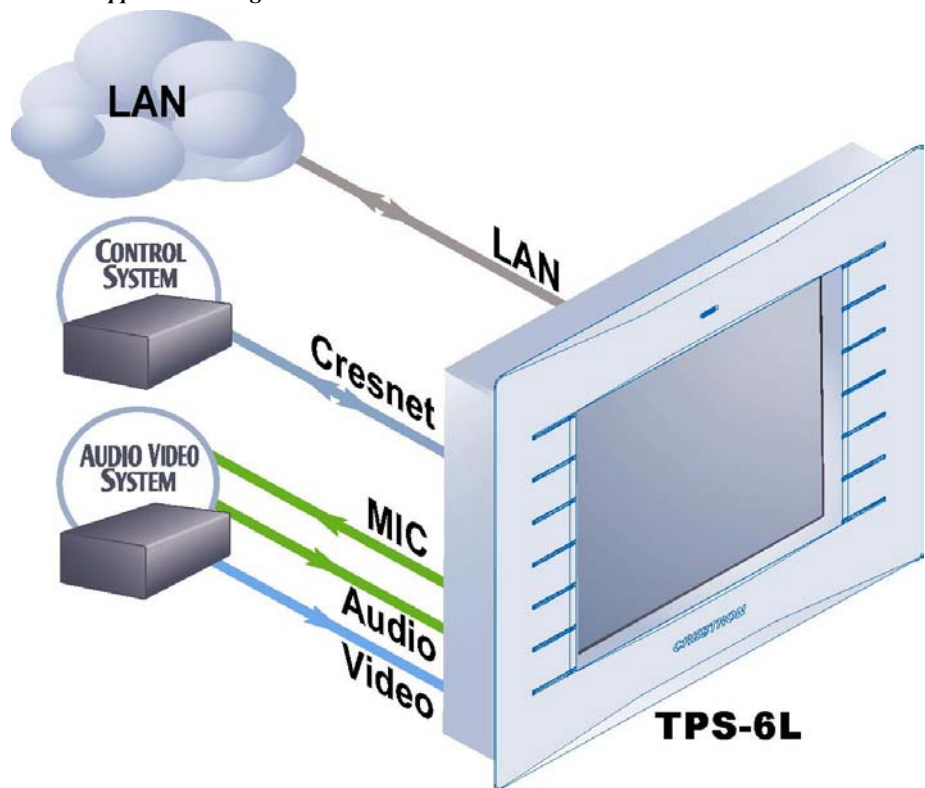

Internal Block Diagram

The following diagram represents the basic operation of the TPS-6L.

TPS-6L Internal Block Diagram

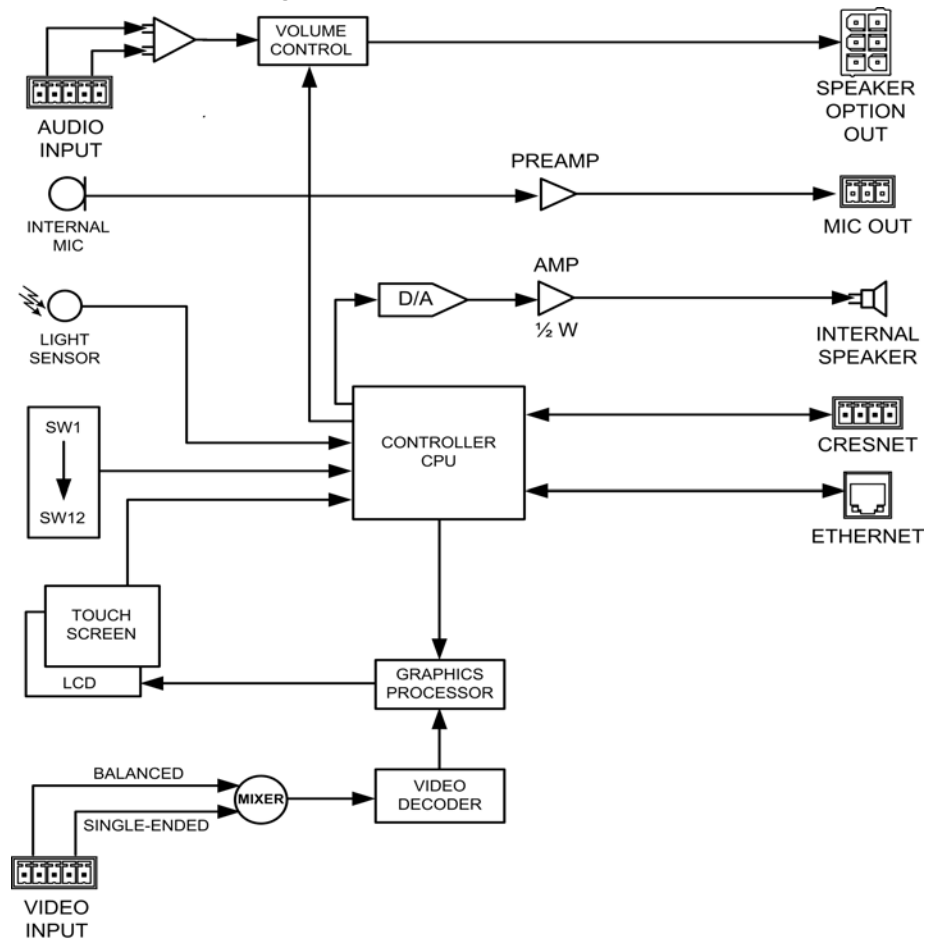

Specifications

Specifications for the TPS-6L are listed in the following table.

TPS-6L Specifications

SPECIFICATION	DETAILS
Touchscreen Display	
Display Type	TFT Active matrix color LCD
Size	5.7 inch (14.48 cm) diagonal
Aspect Ratio	4:3 VGA
Resolution	640 x 480 pixels
Brightness	400 nits
Contrast	400:1
Color Depth	18-bit, 256 k colors
Illumination	Backlit fluorescent

(Continued on following page)

TPS-6L Specifications (Continued)

SPECIFICATION	DETAILS
Touchscreen Display (Continued)	
Viewing Angle	±80° horizontal, +80°/-70° vertical
Touchscreen	Resistive membrane
Processor	
CPU	32-bit Freescale ColdFire [®] Microprocessor
Memory	
SDRAM	32 MB
Flash	32 MB
Maximum Project Size	28 MB
Graphic Engine	Isys engine; 16-bit non-palette graphics; 65536 colors; Synapse image rendering algorithm; multi-mode objects; dynamic graphics ¹ ; PNG translucency, full motion (60 fps) animation; color key video windowing
Ethernet	10BaseT/100BaseTX, auto switching, auto-negotiating, autodiscovery, full/half duplex, TCP/IP, UDP/IP, CIP, DHCP, IEEE 802.3U compliant
Video	
Signal Types	Composite
Formats	NTSC 480i or PAL 576i
Color Depth	18-bit, 262,144 colors
Windowing	Single window, deinterlaced and scalable up to full screen
Audio	
Hardware Features	Built-in microphone, internal speaker for WAV/keyclick, optional amplified speaker for program/intercom, internal volume & tone control
Audio Feedback (WAV)	8-bit, PCM, mono, 8 kHz sampling rate
Amplification	0.75 Watt for internal WAV/keyclick speaker, 6 Watts for optional program/intercom speaker (requires SPK-6L speaker kit, sold separately)
Power Requirements	
Cresnet Power Usage	15 Watts (0.625 Amp @ 24 Volts DC)
Default Net ID	03
Minimum 2-Series Control System Update File ^{2,3}	Version 3.137 or later
Environmental	
Temperature	32° to 104°F (0° to 40°C)
Humidity	10% to 90% RH (non-condensing)
Heat Dissipation	51 BTU/Hr

(Continued on following page)

TPS-6L Specifications (Continued)

SPECIFICATION	DETAILS
Enclosure	
Construction	Injection molded plastic, flush mountable using (4) clips provided (additional mounting kits available)
Faceplate	Injection molded plastic, button and no-button faceplates included, optional solid or backlit engraving sold separately
Dimensions	
Height	5.60 in (14.23 cm)
Width	7.40 in (18.80 cm)
Depth	2.28 in (5.78 cm) 3.58 in (9.08 cm) with SPK-6L speaker kit (sold separately)
Weight	1.52 lbs (0.69 kg)
Available Models	
TPS-6LA-T	Isys 5.7" Wall Mount Touchpanel, Almond, Textured
TPS-6LB-T	Isys 5.7" Wall Mount Touchpanel, Black, Textured
TPS-6LW-T	Isys 5.7" Wall Mount Touchpanel, White, Textured
Included Accessories	
TPS-6L-FP(A,B,W)-T	Button Faceplate w/o Engraving (specify color)
TPS-6L-FP(A,B,W)-T-NB	No-Button Faceplate w/o Engraving (specify color)
Available Accessories	
SPK-6L	Speaker Kit
TPS-6L-FP(A,B,W)-T	Button Faceplate w/Custom Engraving (specify color)
TPS-6L-FP-BKLT-(A,B,W)-T	Backlit Button Faceplate w/Custom Engraving (specify color)
TPS-6L-FP(A,B,W)-T-NB	No-Button Faceplate w/Custom Engraving (specify color)
BB-6L	Pre-Construction Wall Mount Back Box
PMK-6L	Pre-Construction Wall Mount Kit
TMK-6L	Trim Ring
MMK-6L	Mud Ring
WMKT-6L	Lectern or Post-Construction Wall Mount Kit with Trim Ring
WMKM-6L	Post-Construction Wall Mount Kit with Mud Ring
WMKB-6L	Replacement Wall Mount Clips
RMK-6L	Rack Mount Kit
CresCAT®D	Crestron Home CAT5 Balanced AV Cable

1. The panel will not load dynamic graphics if they are located on a password protected HTTP server.
2. The latest software versions can be obtained from the Crestron website. Refer to the NOTE following these footnotes.

3. Crestron 2-Series control systems include the AV2 and PRO2. Consult the latest Crestron Product Catalog for a complete list of 2-Series control systems.

NOTE: Crestron software and any files on the website are for Authorized Crestron dealers and Crestron Authorized Independent Programmers (CAIP) only. New users may be required to register to obtain access to certain areas of the site (including the FTP site).

Physical Description

This section provides information on the connections, controls and indicators available on your TPS-6L.

TPS-6L Physical View (with Button Bezel)

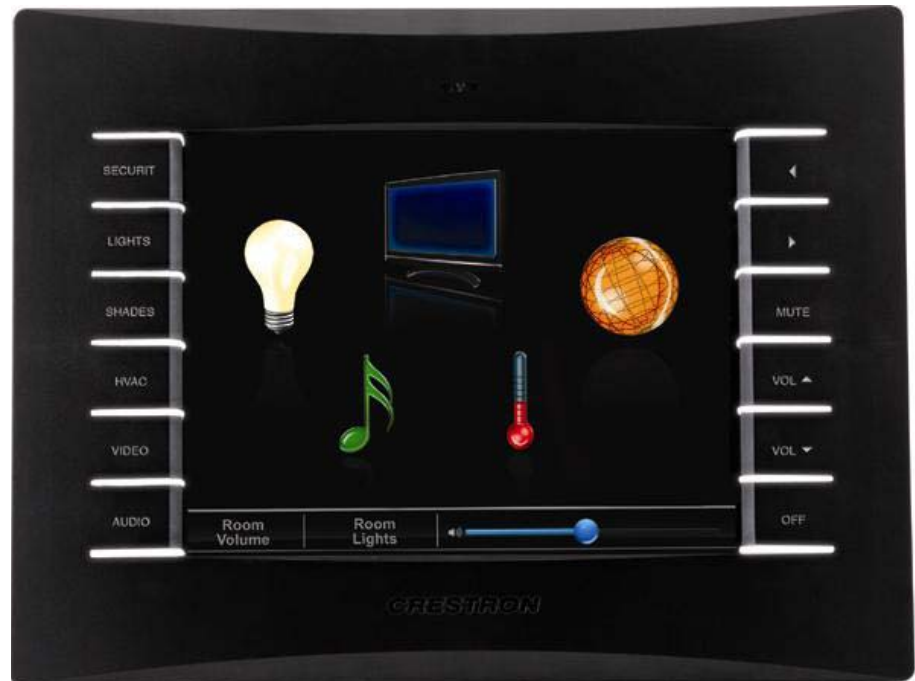

TPS-6L Dimensions – Front and Side View with Cutaway Showing Internal Controls

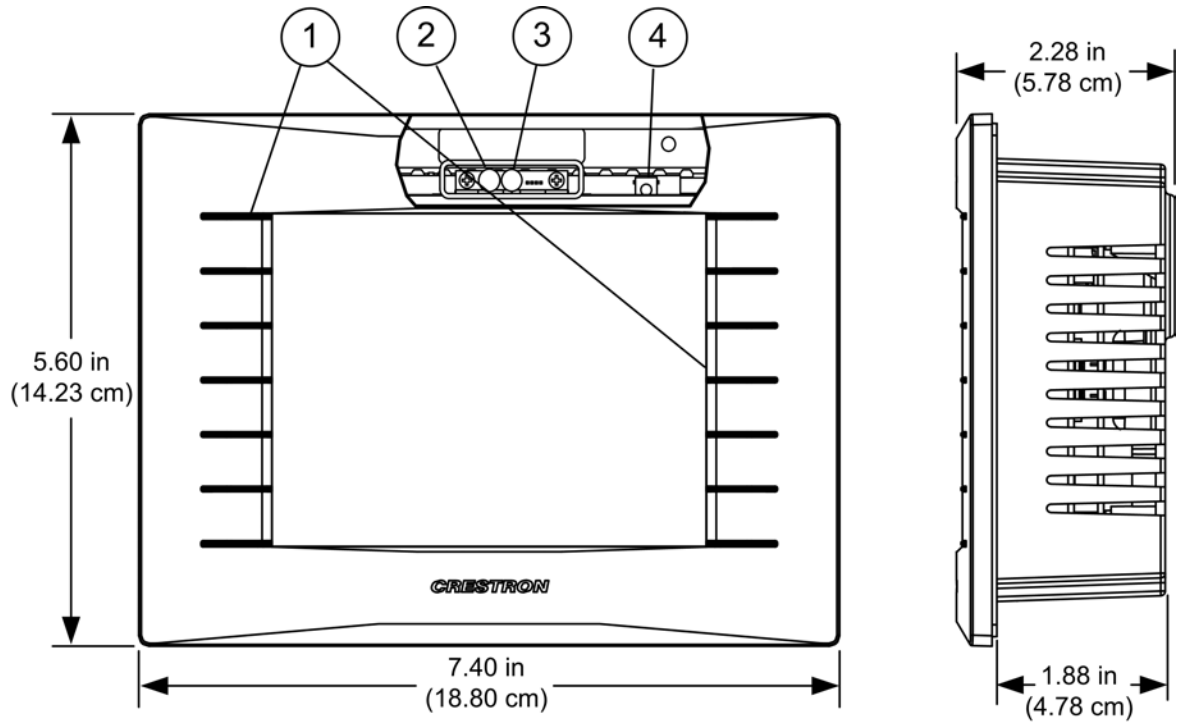

TPS-6L Dimensions and Connections – Rear View

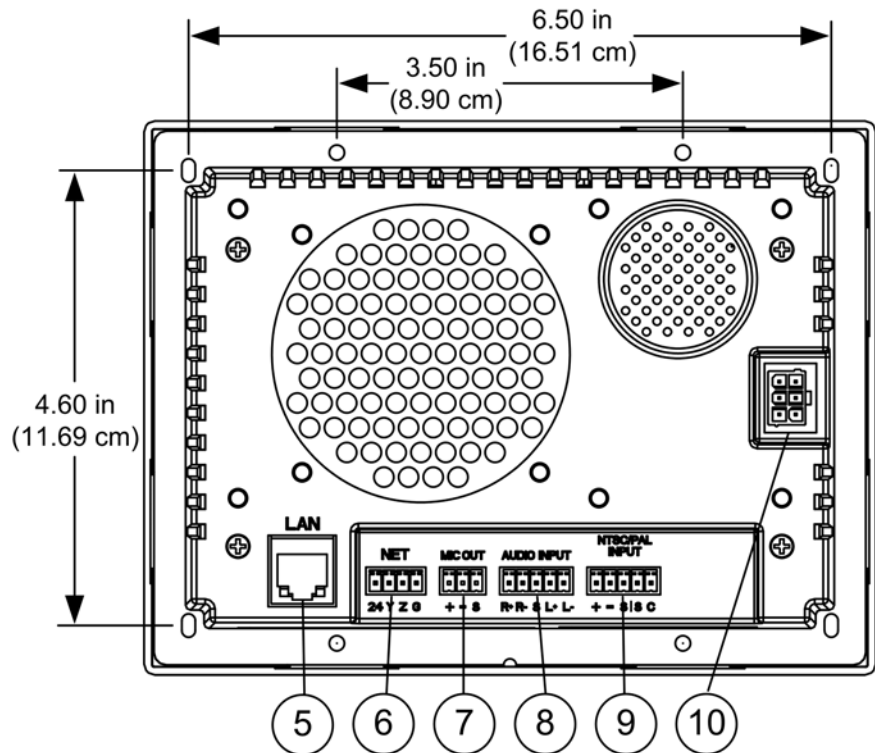

Connectors, Controls & Indicators

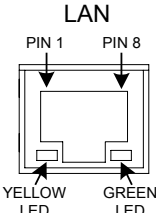
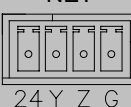
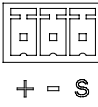
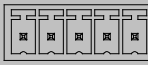
#	CONNECTORS ¹ , CONTROLS & INDICATORS	DESCRIPTION																				
1	BUTTONS	(12) Optional engravable pushbuttons with available backlighting. A non-pushbutton bezel is also provided if the buttons are not desired. Refer to "Pushbutton Options" on page 2 for additional details.																				
2	MICROPHONE	(1) Built-in microphone behind the bezel supports programmable intercom functionality.																				
3	LIGHT SENSOR	Programmable photosensor for automatic backlight dimming. Refer to "Auto Brightness Control" on page 25 for additional information.																				
4	RESET BUTTON ²	(1) Miniature pushbutton behind faceplate, used to reset the touchpanel.																				
5	<p>LAN</p> 	<p>(1) 8-wire RJ-45 with two LED indicators; 10BaseT/100BaseTX Ethernet port; Green LED indicates link status; Yellow LED indicates Ethernet activity</p> <table border="1"> <thead> <tr> <th>PIN</th> <th>SIGNAL</th> <th>PIN</th> <th>SIGNAL</th> </tr> </thead> <tbody> <tr> <td>1</td> <td>TX +</td> <td>5</td> <td>N/C</td> </tr> <tr> <td>2</td> <td>TX -</td> <td>6</td> <td>RC -</td> </tr> <tr> <td>3</td> <td>RC+</td> <td>7</td> <td>N/C</td> </tr> <tr> <td>4</td> <td>N/C</td> <td>8</td> <td>N/C</td> </tr> </tbody> </table>	PIN	SIGNAL	PIN	SIGNAL	1	TX +	5	N/C	2	TX -	6	RC -	3	RC+	7	N/C	4	N/C	8	N/C
PIN	SIGNAL	PIN	SIGNAL																			
1	TX +	5	N/C																			
2	TX -	6	RC -																			
3	RC+	7	N/C																			
4	N/C	8	N/C																			
6	<p>NET</p> 	<p>(1) Four-position terminal block connector for data and power. Connects to Cresnet control network.</p> <ul style="list-style-type: none"> Pin 1 (24) Power Pin 2 (Y) Data Pin 3 (Z) Data Pin 4 (G) Ground 																				
7	<p>MIC OUT</p> 	<p>(1) 3-pin 3.5mm detachable terminal block; Balanced mono line level output; Output impedance: 600 Ω balanced, 300 Ω unbalanced; Maximum output level: 2 V_{rms} balanced, 1 V_{rms} unbalanced</p>																				
8	<p>AUDIO INPUT</p> 	<p>(1) 5-pin 3.5mm detachable terminal block; Balanced/unbalanced stereo (summed to mono) line level input (requires SPK-6L speaker kit, sold separately); Input impedance: 10 kΩ balanced, 5 kΩ unbalanced; Maximum input level: 2 V_{rms} balanced/unbalanced; Normally connects to a Crestron CAT5 balanced audio source via CresCAT cable³; Maximum CAT5 cable length: 1000 feet</p>																				

(Continued on following page)

Connectors, Controls & Indicators (Continued)

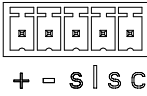
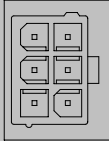
#	CONNECTORS ¹ , CONTROLS & INDICATORS	DESCRIPTION
9	NTSC/PAL INPUT 	(1) 5-pin 3.5mm detachable terminal block; Balanced (CAT5) or unbalanced (coaxial) composite video inputs; Formats: NTSC 480i or PAL 576i; Input impedance: 100 Ω balanced, 75 Ω unbalanced; Input level: 1 V _{p-p} nominal; Balanced input normally connects to a Crestron CAT5 balanced video source via CresCAT cable ³ ; Maximum CAT5 cable length: 750 feet
10	SPEAKER OPTION 	(1) Six-pin (2x3) rectangular connector; Connects to optional SPK-6L speaker kit (sold separately).

1. Interface connectors for NET, MIC OUT, AUDIO INPUT, and NTSC/PAL INPUT ports are provided with the unit.
2. To access the reset button, remove the bezel and then use a narrow blunt instrument such as the end of a ballpoint pen to press the button.
3. For details on CAT5 wiring, refer to the latest version of the CAT5 Reference Guide (Doc. 6137), which is available for download from the Crestron website (www.crestron.com/manuals).

CAUTION: Do not attempt to press the reset button by inserting a paperclip or similar device through the small hole in the bezel. This could cause physical damage to the microphone or the light sensor, or a short circuit on the printed circuit board located in that area. Remove bezel to access the reset button.

Industry Compliance

As of the date of manufacture, the TPS-6L has been tested and found to comply with specifications for CE marking and standards per EMC and Radiocommunications Compliance Labelling.



NOTE: This device complies with part 15 of the FCC rules. Operation is subject to the following two conditions: (1) this device may not cause harmful interference and (2) this device must accept any interference received, including interference that may cause undesired operation.

This equipment has been tested and found to comply with the limits for a Class B digital device, pursuant to part 15 of the FCC Rules. These limits are designed to provide reasonable protection against harmful interference in a residential installation. This equipment generates, uses and can radiate radio frequency energy and if not installed and used in accordance with the instructions, may cause harmful interference to radio communications. However, there is no guarantee that interference will not occur in a particular installation. If this equipment does cause harmful interference to radio or television reception, which can be determined by turning the equipment off and on, the user is encouraged to try to correct the interference by one or more of the following measures:

- Reorient or relocate the receiving antenna.
 - Increase the separation between the equipment and receiver.
 - Connect the equipment into an outlet on a circuit different from that to which the receiver is connected.
 - Consult the dealer or an experienced radio/TV technician for help.
-

Setup

Network Wiring

When wiring the Cresnet® or Ethernet network, consider the following:

- Use Crestron Certified Wire.
- Use Crestron power supplies for Crestron equipment.
- Provide sufficient power to the system.

CAUTION: Insufficient power can lead to unpredictable results or damage to the equipment. Please use the Crestron Power Calculator to help calculate how much power is needed for the system (www.crestron.com/calculators).

Cresnet

For larger networks, use a Cresnet Hub/Repeater (CNXHUB) to maintain signal quality.

For more details, refer to “Check Network Wiring” on page 46.

Ethernet

The TPS-6L can also use high-speed Ethernet for communications between the device and a control system, computer, digital media server and other IP-based devices.

For information on connecting Ethernet devices in a Crestron system, refer to the latest version of the Crestron e-Control® Reference Guide (Doc. 6052), which is available for download from the Crestron website (www.crestron.com/manuals).

Identity Code

Net ID

The Net ID of the TPS-6L has been factory set to **03**. The Net IDs of multiple TPS-6L devices in the same system must be unique. The Net ID is set using the internal setup menu (refer to “Interface Menu” which starts on page 15). The Net ID may also be set from a personal computer (PC) via the Crestron Toolbox™ (refer to “Establishing Communication” on page 43).

When setting the Net ID, consider the following:

- The Net ID of each unit must match an ID code specified in the SIMPL™ Windows® program.
- Each network device must have a unique Net ID.

For more details, refer to the Crestron Toolbox help file.

IP ID

The IP ID is set within the TPS-6L’s table using Crestron Toolbox. For information on setting an IP table, refer to the Crestron Toolbox help file. The IP IDs of multiple TPS-6L devices in the same system must be unique.

When setting the IP ID, consider the following:

- The IP ID of each unit must match an IP ID specified in the SIMPL Windows program.
- Each device using IP to communicate with a control system must have a unique IP ID.

Configuring the Touchpanel

NOTE: The only connection required to configure the touchpanel is power. Refer to “Hardware Hookup” which starts on page 34 for details.

To configure the unit, it may be necessary to access a series of setup screens prior to viewing run-time screens that are loaded into the touchpanel for normal operation. The MAIN MENU for configuring the touchpanel appears when a finger is held to the touchscreen as power is applied, after the hardware reset button is pressed and released or after touching the supplied opening screen. Refer to the following illustration.

Opening Screen



Upon entering Setup Mode, the MAIN MENU, as shown in the following illustration, displays four buttons: **Touch Screen Calibration**, **Exit and Run Program**, **Setup** and **Diagnostics**.

After all setup procedures are completed, press **Exit and Run Program** to save the information to EEPROM and exit Setup Mode.

MAIN MENU

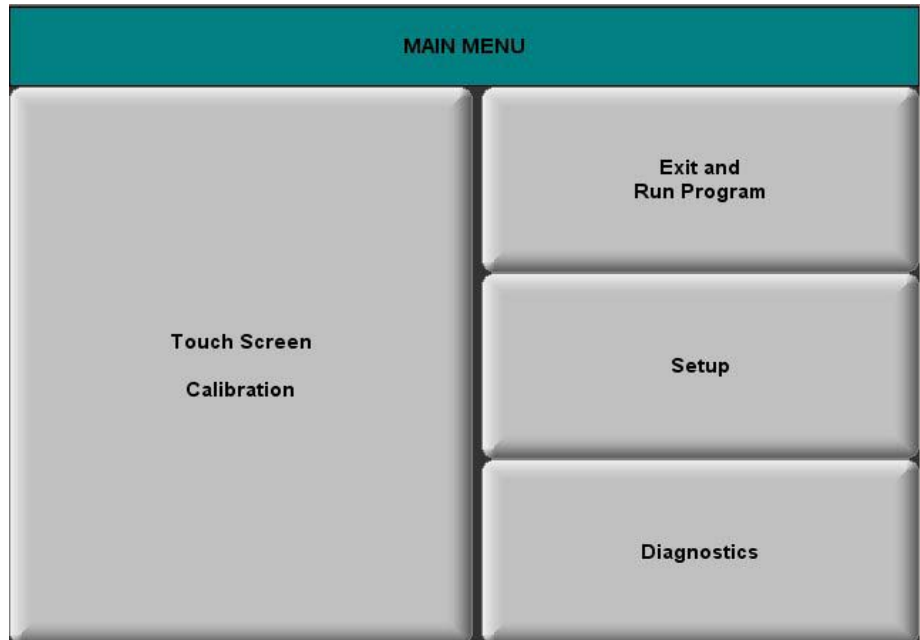

Calibration Menu

Before beginning other setup procedures, it is advisable to perform screen calibration. Press **Touch Screen Calibration** to display the CALIBRATION MENU, as shown in the following illustration.

CALIBRATION MENU

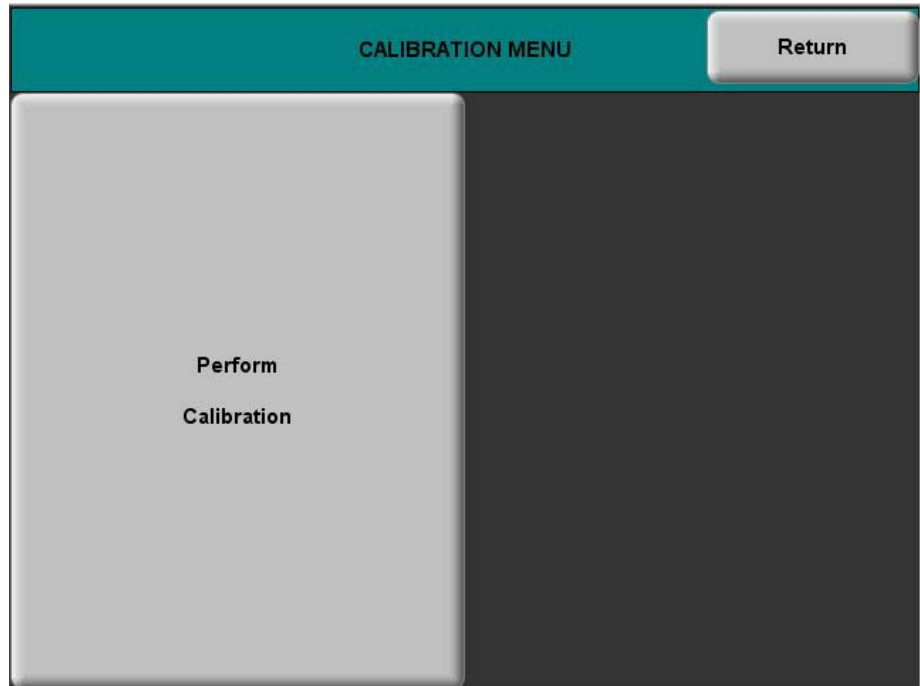

Touch **Perform Calibration**. The message “Touch Upper Left” appears centered on the panel with a cross hair in the upper left corner. Touch the center of the cross hair in the corner of the screen to initiate calibration. Another message, “Touch Upper Right”, appears with a cross hair in the correct corner. Touch the center of the cross

hair in the corner of the screen. A final message, “Touch Lower Right”, appears with a cross hair in the correct corner. Touch the center of the cross hair in the corner of the screen to conclude calibration and return to the MAIN MENU.

NOTE: When touching the screen during calibration, be as accurate as possible. Use the tip of a capped pen or the eraser end of a pencil. To cancel calibration and return to the MAIN MENU without saving calibration data, create a calibration error by touching the screen in the same spot three times.

Setup Menu

To obtain the SETUP MENU, press the **Setup** button from the MAIN MENU. The SETUP MENU offers a series of buttons that open additional menus and displays, which are detailed in subsequent paragraphs. The SETUP MENU also provides a series of buttons at the bottom that permit easy application of the backlit engraving setting preset values. Refer to “Backlit Engraving Settings” which starts on page 23 for details.

After all setup parameters have been selected, select the **Return** button to return to the MAIN MENU.

NOTE: For convenience, the current *Cresnet ID* setting is displayed in the upper left corner.

NOTE: All touchpanel settings are automatically saved in non-volatile memory (on exit from setup).

SETUP MENU



Interface Menu

The touchpanel communicates with a control system to activate commands or to display feedback from components within the system. The communication interface must be correctly specified or communication will not occur. To set communication

parameters, select the **Interface** button located on the SETUP MENU and display the INTERFACE MENU, shown below.

The Cresnet network identity number (*Cresnet ID* also known as the Net ID) is displayed on the INTERFACE MENU. Net ID is a two-digit hexadecimal number that can range from 03 to FE and must correspond to the Net ID set in the SIMPL Windows program of the Cresnet system. Matching IDs between touchpanel and SIMPL Windows program is required if data is to be successfully transferred. The Net ID for the TPS-6L is factory set to 03. No two devices in the same system can have the same Net ID.

INTERFACE MENU

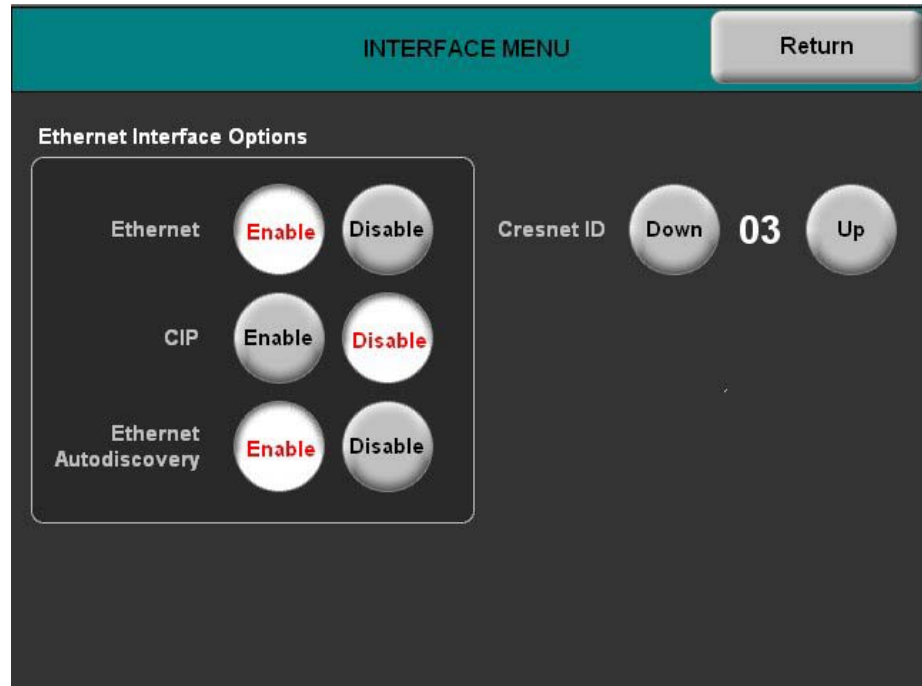

Each press of the *Cresnet ID* buttons, **DOWN** and **UP**, decreases and increases the Net ID by one, respectively.

Use the other buttons on the screen to enable/disable the preferred communications protocol: *Ethernet*, *CIP* (Crestron Internet Protocol), or *Ethernet Autodiscovery*.

The *Ethernet* **Enable** and **Disable** buttons determine the touchpanel's ability to communicate with other devices via Ethernet.

The *CIP* **Enable** and **Disable** buttons determine the touchpanel's ability to communicate with other Crestron devices using CIP. CIP must be enabled for the touchpanel to communicate with other Crestron Ethernet devices.

The *Ethernet Autodiscovery* **Enable** and **Disable** buttons determine the touchpanel's ability to automatically locate other Ethernet devices on the network.

After the *Cresnet ID* setting has been verified and the communications protocol has been selected, press **Return** to save the settings and return to the SETUP MENU.

Ethernet Menu

To set the Ethernet communication parameters, select the **Ethernet** button located on the SETUP MENU and display the ETHERNET MENU, shown on the following page.

The menu shows the current IP address. The **LINK STATUS** button shows if the Ethernet link is active (green) or inactive (gray).

With *DHCP* enabled (default), the bottom buttons let you renew or release DHCP functions. When you press each button, the button legend changes to **Working** until the selected function is completed.

NOTE: If DHCP is unable to locate an IP address, a notice appears on the screen.

Press the *DHCP Disable* button to display the *Static IP Settings* submenu, shown below, in place of the *DHCP Functions* submenu. The bottom buttons are now used to select static IP settings **IP Address** and **DNS Servers**. Refer to subsequent illustrations on pages 18 and 19.

ETHERNET MENU

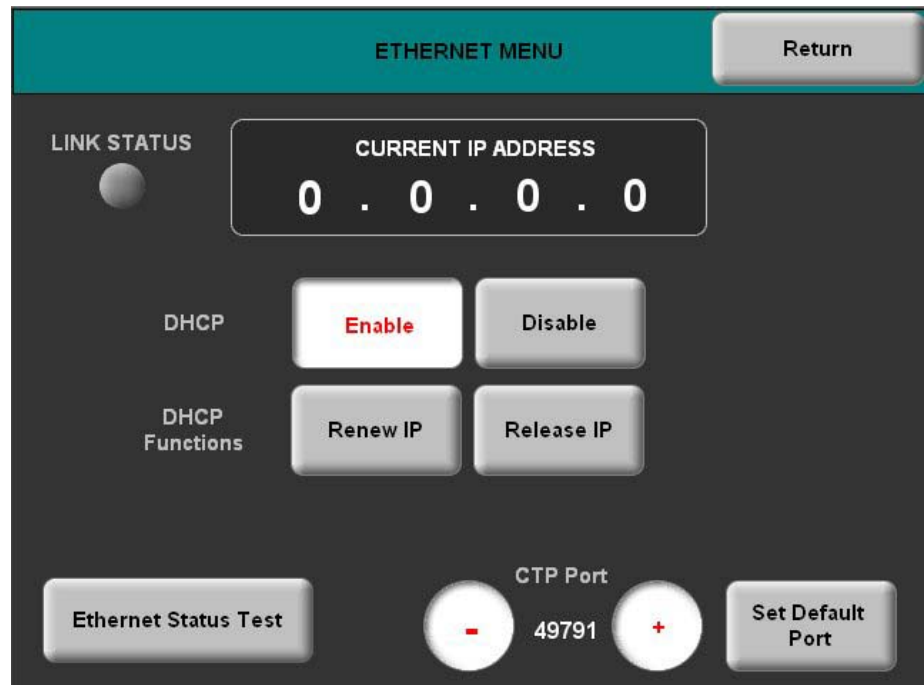

Static IP Settings Submenu



- Press the **IP Address** button to display the STATIC IP SETTINGS menu, as shown on the following page.
- Pressing the **DNS Servers** button displays the STATIC DNS SETTINGS menu as shown on page 18.

Press the **Ethernet Status Test** button to see an on-screen report of the status of the Ethernet link, including details if there is an error.

Use the + and – buttons to adjust the setting of the CTP port. To select the default port, press the **Set Default Port** button.

STATIC IP SETTINGS Menu

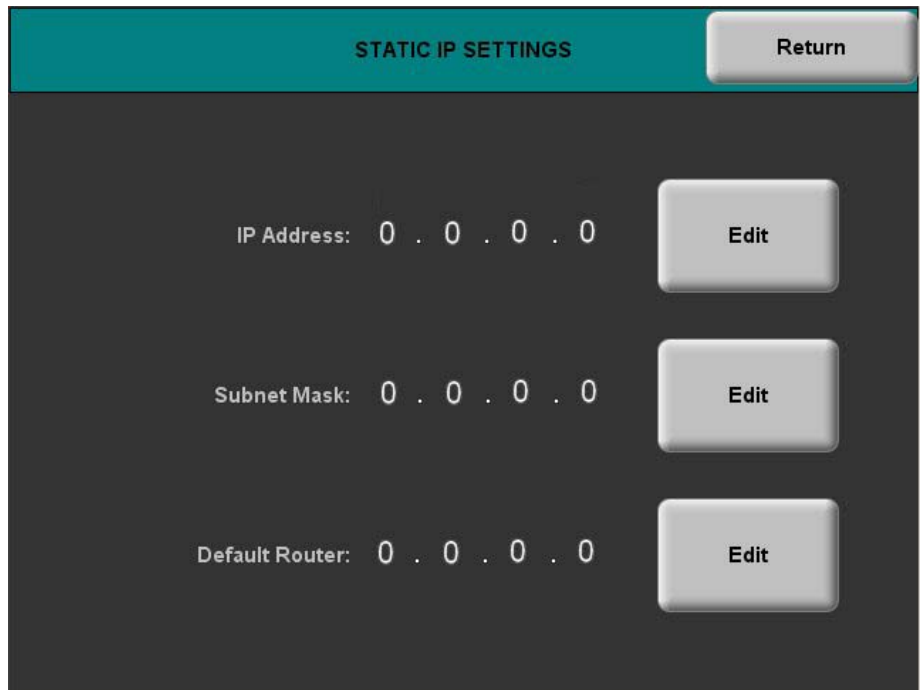

- Press the appropriate **EDIT** buttons to display submenus that let you change the IP address, the subnet mask, and the default router address. Each **EDIT** button selection displays a submenu similar to the following:

EDIT IP ADDRESS Submenu

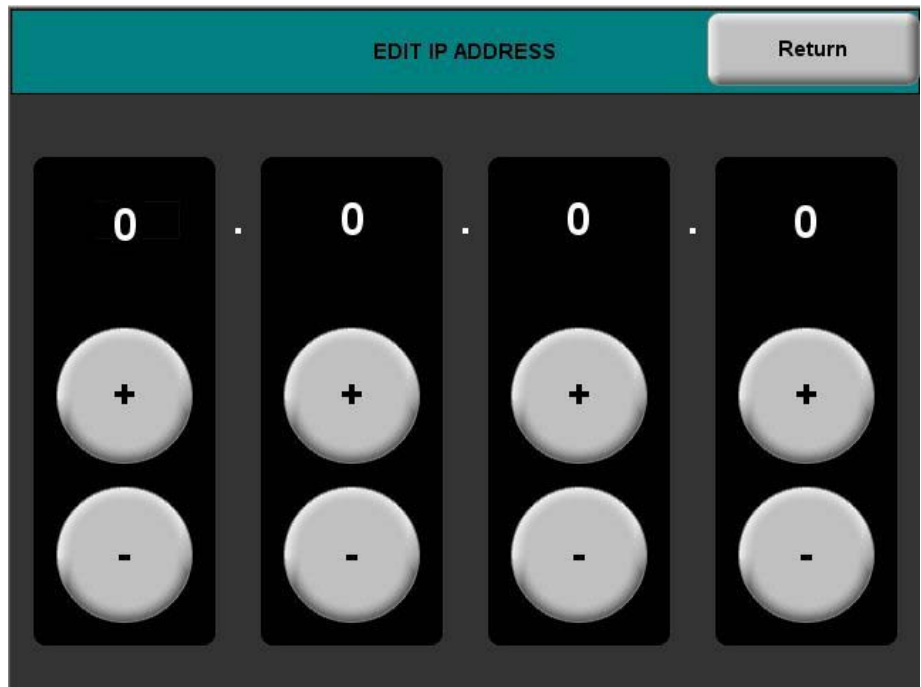

- Press **Return** to go back to the ETHERNET MENU.

STATIC DNS SETTINGS Menu

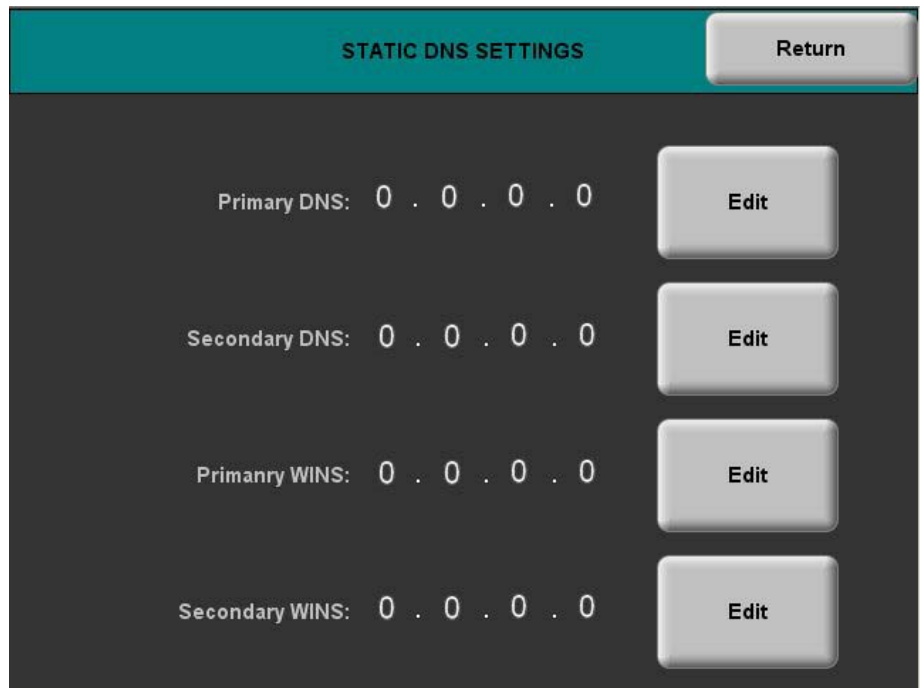

- Press the **EDIT** buttons to display submenus that let you edit the primary and secondary DNS addresses, and the primary and secondary WINS addresses. Each **EDIT** submenu is similar to the following:

EDIT PRIMARY DNS Submenu

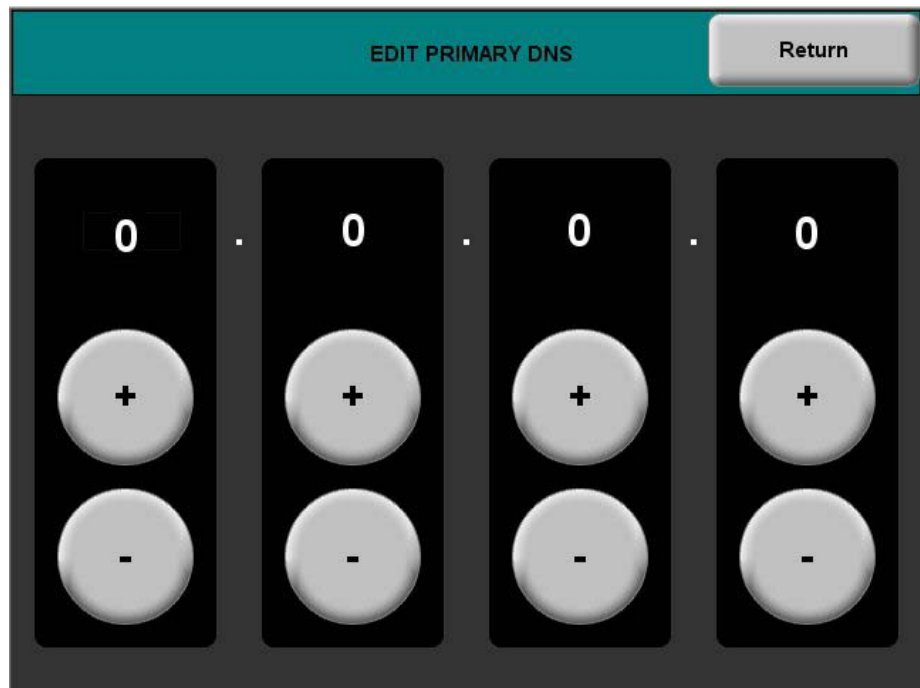

- Press **Return** to go back to the ETHERNET MENU.

Audio Menu

To set the audio communication parameters, select the **Audio** button located on the SETUP MENU and display the following AUDIO SETUP menu.

AUDIO SETUP Menu – Audio Main

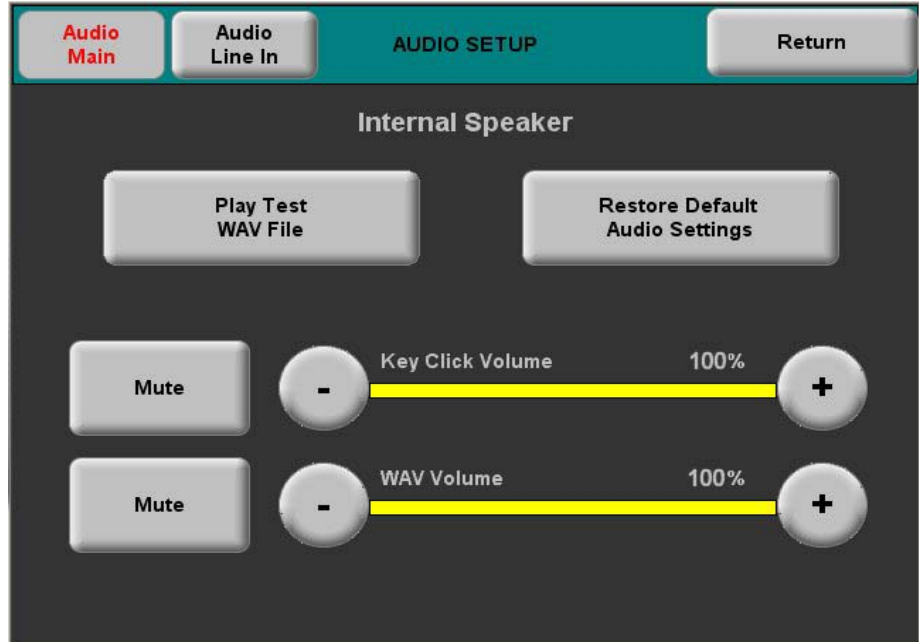

- With the **Audio Main** button pressed (default), you can verify the function of the internal speaker, restore default audio settings and adjust the relative level (0% to 100%) or mute the key click volume and the WAV file volume.
- Pressing **Audio Line In** displays the following menu screen which is used to set levels for the speaker option, SPK-6L, if installed.

AUDIO SETUP Menu – Audio Line In

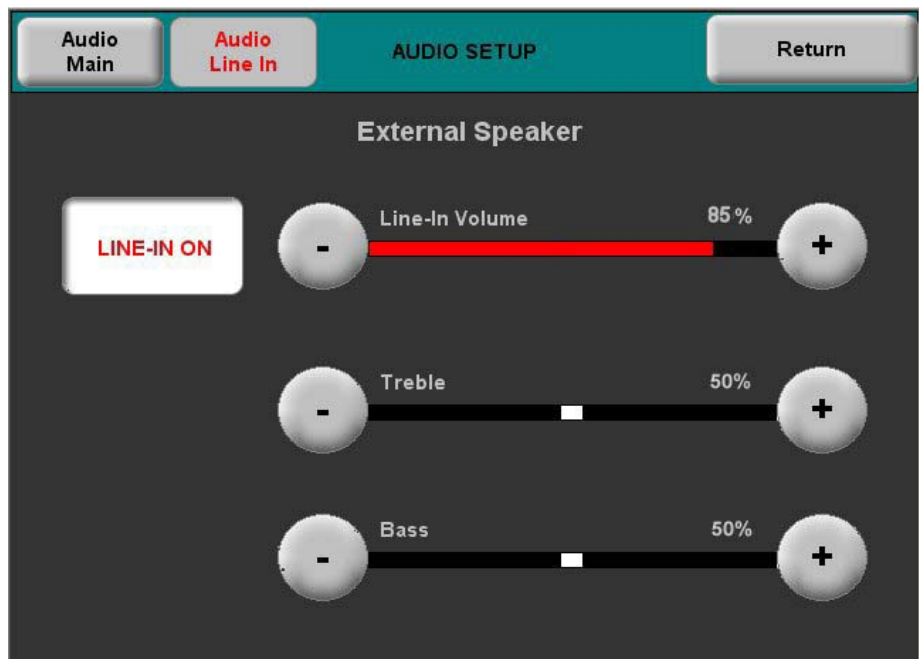

- With the **LINE-IN** button set to **ON** (default), you can adjust the volume as well as the bass and treble levels. Pressing the **LINE IN** button turns it to **OFF**.
- Press **Return** to return to the SETUP MENU.

Video Menu

To set the video parameters, select the **Video** button located on the SETUP MENU and display the VIDEO SETUP menu, shown below.

VIDEO SETUP Menu

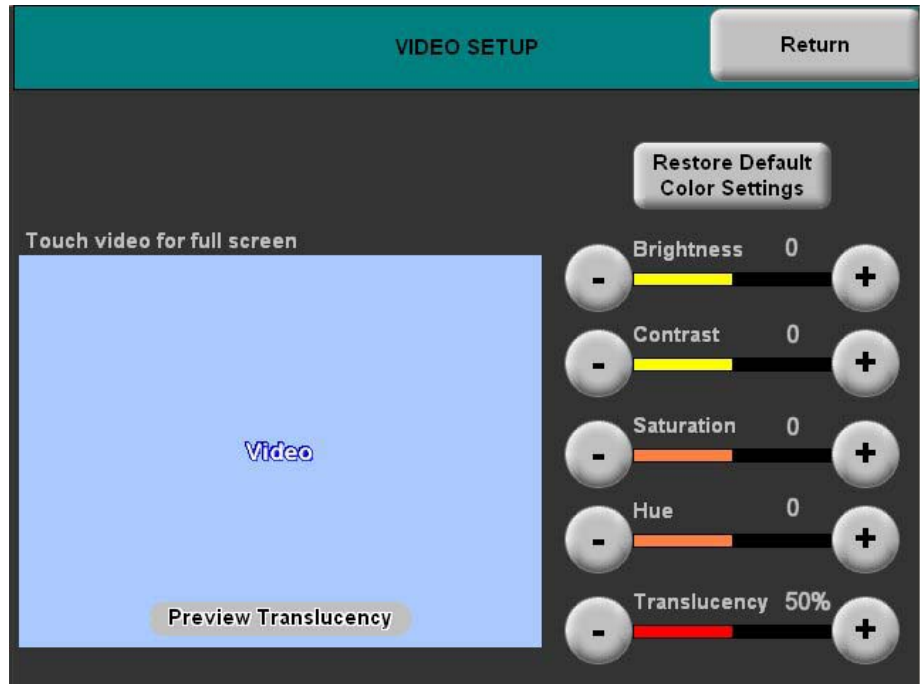

- Adjust the controls as desired for best viewing under local conditions.

NOTE: A video signal must be present in order to view the affects of adjusting the controls.

- The blue *Video* area is provided to preview the effect of the translucency settings. (“Preview Translucency” is a label, not a button.)
- Touch the *Video* area to change it to a full screen display, as shown in the following illustration.
- Press **Restore Default Color Settings** as necessary to cancel all setting changes.
- Press **Hide Controls** to remove the controls from the display. The button legend changes to **Show Controls** to let you display them for further adjustment.

Full Screen Video Display

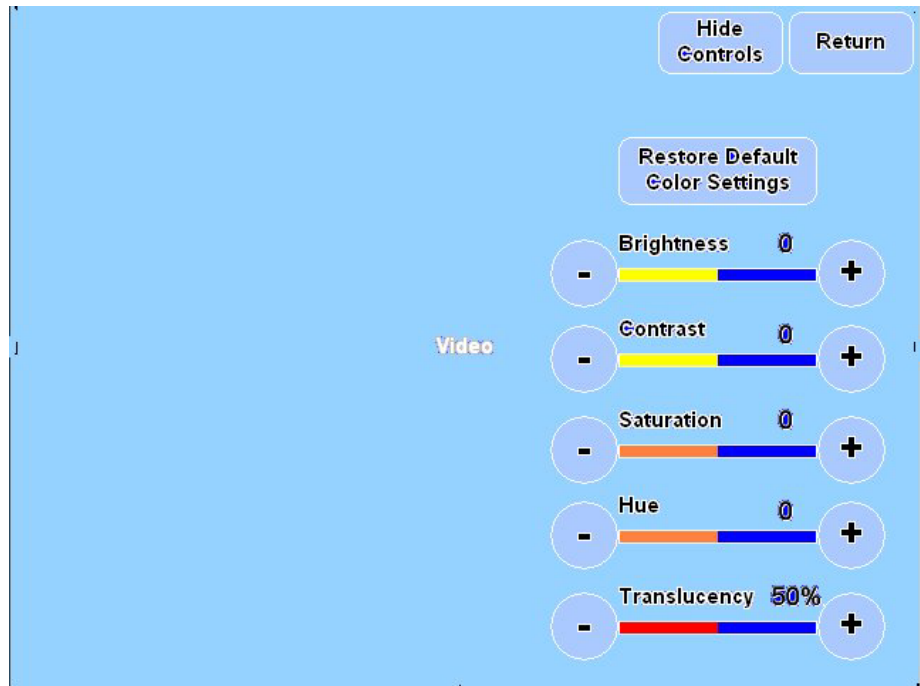

- Press **Return** to return to the SETUP MENU screen.

Screen Settings

From the SETUP MENU screen, press **Screen Settings** to display the SCREEN SETTINGS menu as shown below.

SCREEN SETTINGS Menu

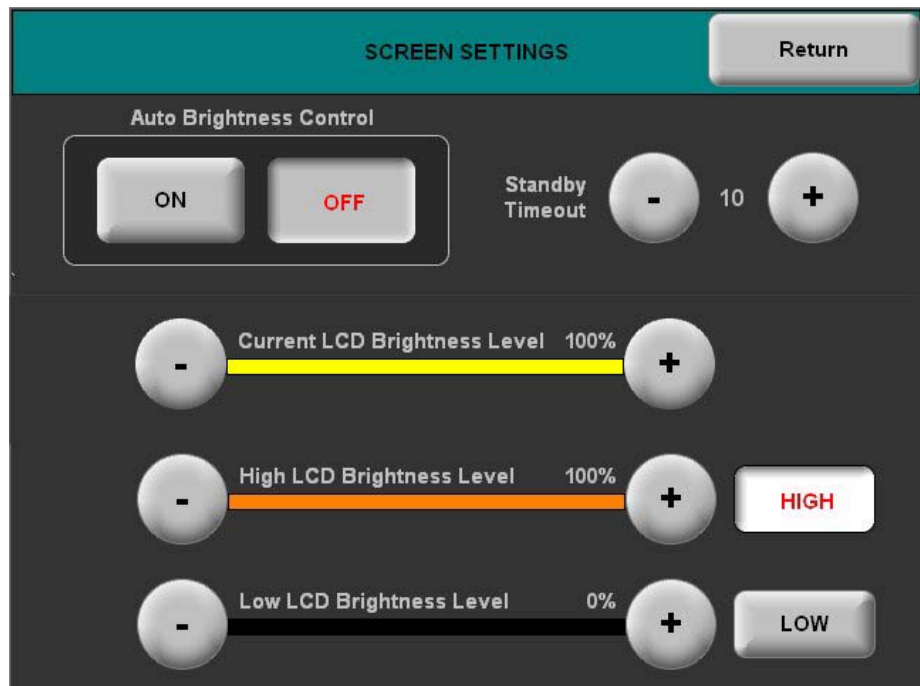

- With *Auto Brightness Control* set to **OFF** (default), the screen brightness is at the level set by the screen brightness controls.

- Use the controls to adjust the relative level (0% to 100%) of current brightness, and the high and low preset brightness levels. Press the **HIGH** and **LOW** buttons to check each level.
- With *Auto Brightness Control* set to **ON**, the *Current LCD Brightness Level* display changes to show the *LCD Threshold* value and the *Light Sensor Level*, as shown in the following figure.

LCD Threshold and Light Sensor Level



The internal light sensor adjusts the brightness level to accommodate for the current room ambience. If the light level is above the threshold, the brightness jumps to the high setting; if the level is below the threshold, brightness jumps to the low setting.

- Use the **LCD Threshold** controls to set the level at which the Auto Brightness, when set to **ON**, will adjust screen brightness. The **Light Sensor Level** gauge is provided as a guide to setting the threshold.
- Use the **Standby Timeout** buttons to define the time (from 0 to 120 minutes) that the display will remain visible without further activity before going into standby mode (screen goes dark).
- Press **Return** to go back to the SETUP MENU screen.

Backlit Engraving Settings

From the SETUP MENU screen, press **Backlit Engraving Settings** to display the BACKLIT ENGRAVING SETTINGS menu as shown below.

BACKLIT ENGRAVING SETTINGS Menu

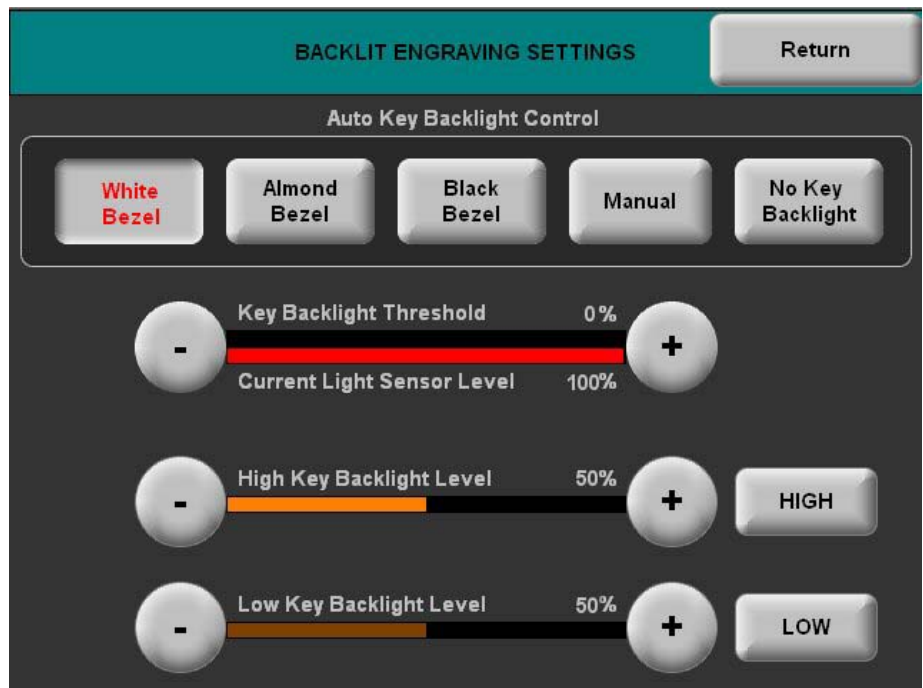

- Press the **White**, **Almond**, or **Black Bezel** button to set the *Auto Key Backlight Control* threshold for the color of your bezel. The *Current Light Sensor Level* value is provided as a reference. The internal light sensor adjusts the brightness level to accommodate for the current room ambience.
 - For white or almond bezels, if the current sensor level is above or equal to the threshold, the brightness is set to the low level. If the current sensor level is below the threshold, the brightness is set to the high level.
 - For black bezels, if the current sensor level is above or equal to the threshold, the brightness is set to the high level. If the current sensor level is below the threshold, the brightness is set to the low level.
 - Use the controls to adjust the relative level (0% to 100%) of key backlight brightness levels. Press the **HIGH** and **LOW** buttons to check each level.
- Press the **Manual** button to adjust the high and low backlight levels manually.
- Press the **No Key Backlight** button if you do not require key backlighting.
- Press **Return** to go back to the SETUP MENU screen.

NOTE: Corresponding buttons on the SETUP MENU let you select the appropriate backlight control mode for current operation.

Advanced Options

From the SETUP MENU screen, press **Advanced Options** to display the ADVANCED OPTIONS MENU as shown below.

ADVANCED OPTIONS MENU

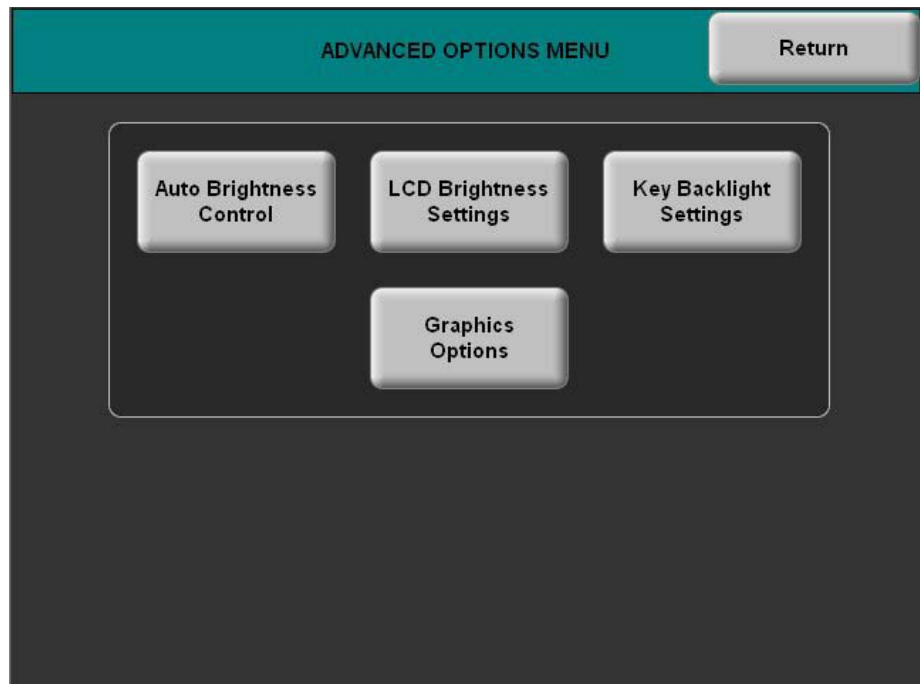

Auto Brightness Control

Select **Auto Brightness Control** to display the AUTO BRIGHTNESS CONTROL SETUP menu as shown below.

AUTO BRIGHTNESS CONTROL SETUP Menu

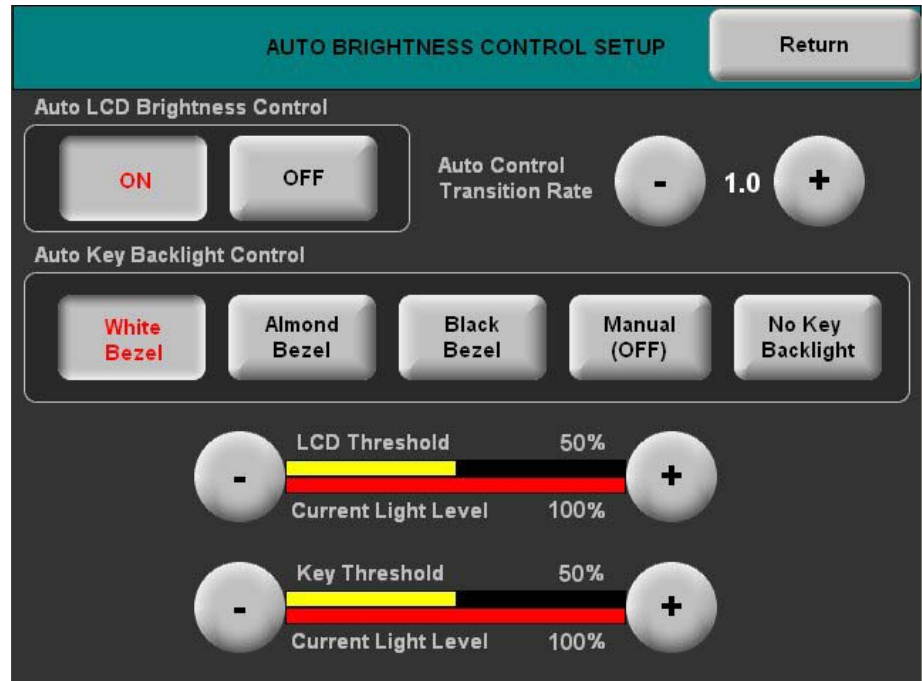

- Press the **ON** and **OFF** (default) *Auto LCD Brightness Control* buttons to turn that feature on and off.
- With auto LCD brightness set to ON, the internal light sensor adjusts the brightness level to accommodate for the current room ambience. If the light level is above the threshold, the brightness jumps to the high setting; if the level is below the threshold, brightness jumps to the low setting.
- Use the *Auto Control Transition Rate* controls to set the time, in seconds, for the brightness setting to transition from one level to the other.
- Use the *LCD Threshold* controls to set the level at which the auto brightness, if set to **ON**, will adjust LCD brightness. The *Current Light Level* gauge is provided as a guide to setting the threshold.
- Use the *Key Threshold* controls to set the level at which the auto backlight control will adjust key backlight brightness. The *Current Light Level* gauge is provided as a guide to setting the threshold.

The threshold value is constant for all bezel colors. What the panel does when the sensor reading crosses the threshold differs for white/almond and black bezels

- For white/almond bezels:
 - When the sensor is below the threshold, the key backlight brightness is set to the high level.
 - When the sensor is above the threshold, the key backlight brightness is set to the low level.

- For black bezels:
 - When the sensor is below the threshold the key backlight brightness is set to the low level.
 - When the sensor is above the threshold the key backlight brightness is set to the high level.
- With **Manual (OFF)** selected, the key backlight brightness is controlled manually (sensor is ignored).
- With **No Key Backlight** selected, the key backlight is turned off, regardless of the sensor reading or other settings.

LCD Brightness Settings

Select **LCD Brightness Settings** to display the LCD BRIGHTNESS menu as shown below.

LCD BRIGHTNESS Menu

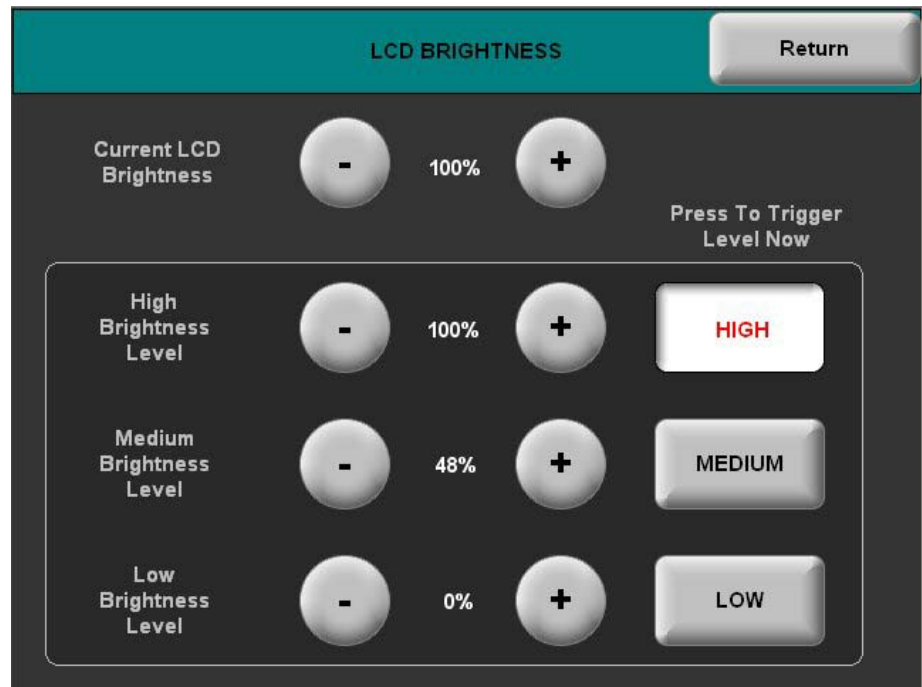

- Use the *Current LCD Brightness* controls to adjust the current screen brightness level as desired.
- Press the **HIGH**, **MEDIUM**, and **LOW** buttons to check the preset levels. Use the *High-*, *Medium-*, and *Low Brightness Level* controls to adjust the preset levels as desired.

Key Backlight Settings

Select **Key Backlight Settings** to display the KEY BACKLIGHT menu as shown on the following page.

KEY BACKLIGHT Menu

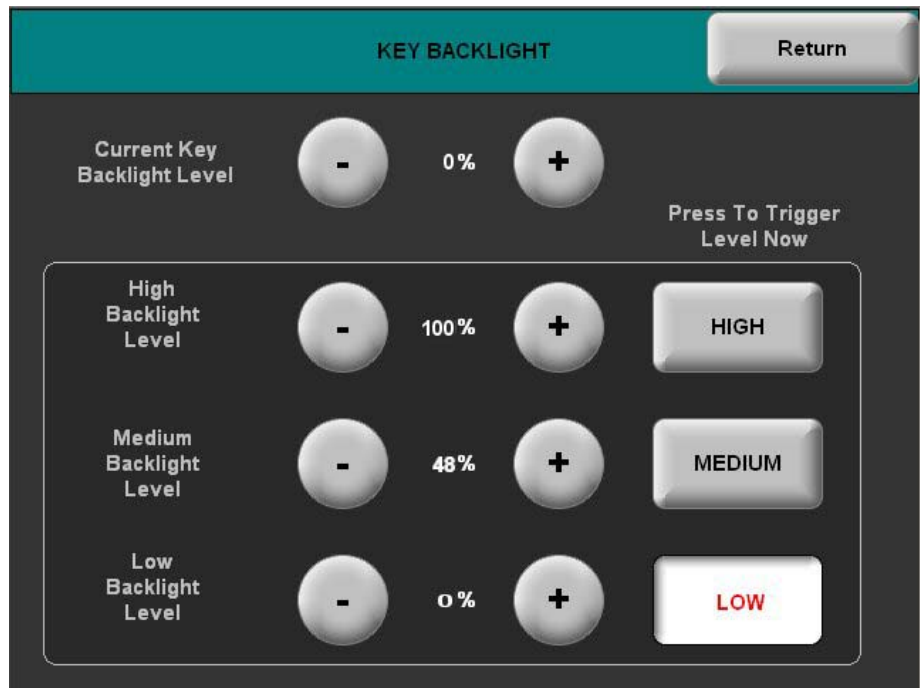

- Use the *Current Key Backlight Level* controls to adjust the current screen brightness level as desired.
- Press the **HIGH**, **MEDIUM**, and **LOW** buttons to check the preset levels. Use the *High-*, *Medium-*, and *Low Backlight Level* controls to adjust the preset levels as desired.

Graphics Options

Select **Graphics Options** to display the GRAPHICS MENU as follows.

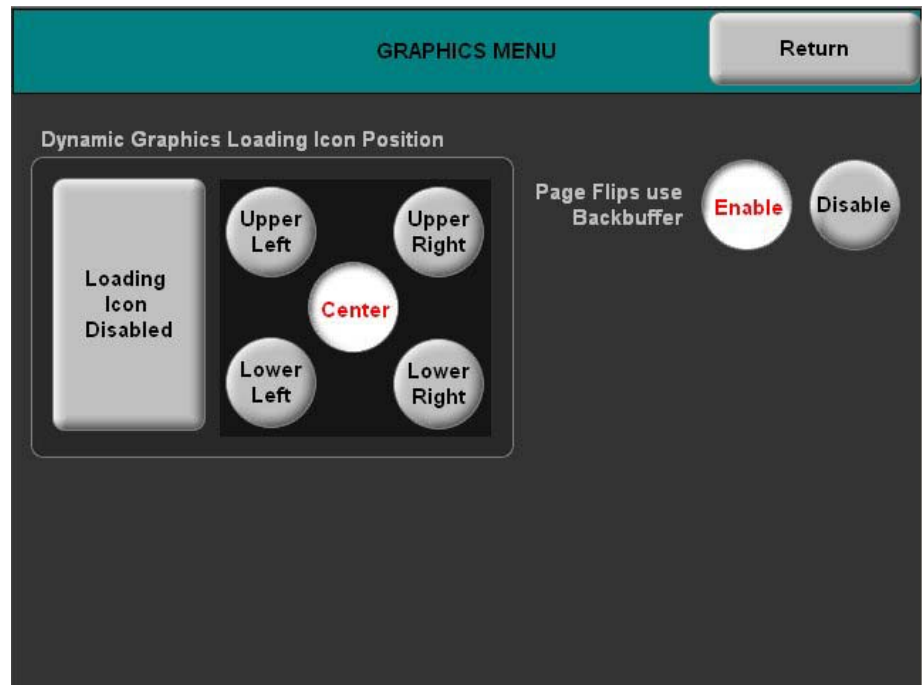
GRAPHICS MENU

The dynamic graphics loading icon is displayed whenever a dynamic graphic image is queued to load, is actively loading or is being decompressed. It will appear as a grey spinning circle if the image has been queued to load, a blue spinning circle if it is actively loading and a solid blue circle while the image is being decompressed.

- By default, the loading icon is enabled and appears in the center position of an object that includes a dynamic graphic image.
- Use the *Dynamic Graphic Loading Icon Position* controls to disable the icon or to select one of the corner positions for its location.

The *Page Flips use Backbuffer* controls permit you to specify how page flips are displayed on the panel.

- If enabled (default), page flips will draw all the objects to the back buffer first. This provides a clean page flip, but can result in a pause between the trigger and the actual page change. This pause can be significant if the new page contains many JPG or other compressed images.

NOTE: Once images are decompressed (displayed for the first time) they are cached and future page flips will occur much faster.

- If disabled, pages flips will draw all the objects to the visible screen. This option provides instant feedback that the page flip has occurred but it is not a clean flip.

Diagnostics

The **Diagnostics** button from the MAIN MENU should only be used under supervision from a Crestron customer service representative during telephone support. Many options available from the DIAGNOSTICS MENU, shown on the following page, are numeric in nature and their interpretation is beyond the scope of this manual.

DIAGNOSTICS MENU

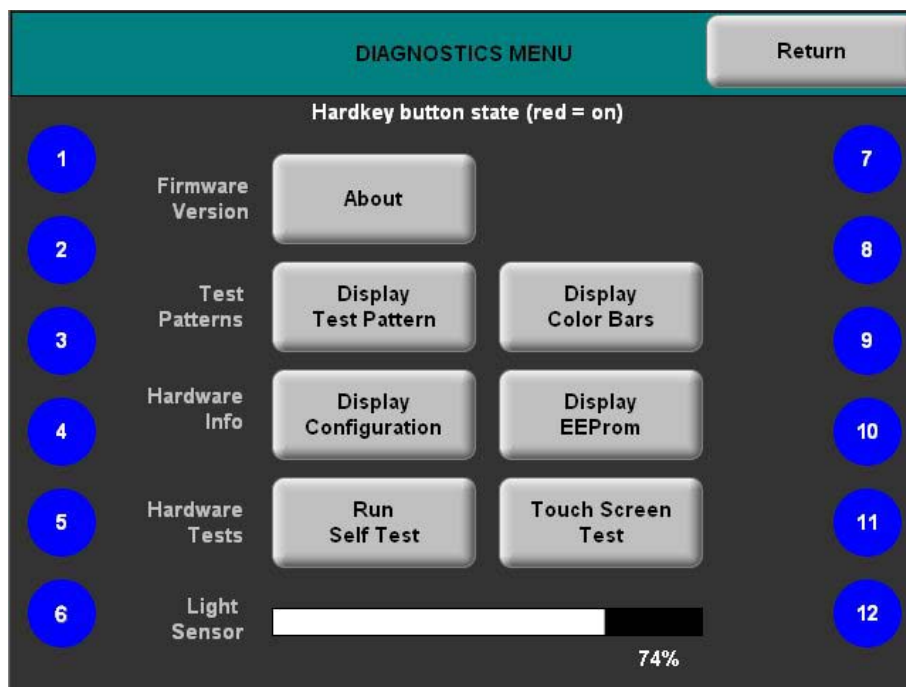

Mounting Options

The TPS-6L touchpanel installs simply and cleanly into existing or newly constructed walls, with an assortment of pre- and post-construction mounting options. The TPS-6L is supplied with four screws and clips for post-construction installation. All available mounting options are listed in the following table. The options listed are provided separately from the actual touchpanel. (The Wall Mount Kit – Bracket, Model WMKB-6L, consists of multiple sets of clips like the ones supplied.)

NOTE: Refer to the latest version of the supplied Touchpanel Mounting QuickStart Guide, Doc. 6140, for details about the available mounting options before starting any actual installation procedures.

Mounting Options for the TPS-6L

PRE-CONSTRUCTION OPTION	POST-CONSTRUCTION OPTION	MODEL NUMBER	DOCUMENT NUMBER
Back Box Kit	-	BB-6L	6551
Pre-Construction Mount Kit	-	PMK-6L	6552
Mud Ring Mount Kit (Accessory)	-	MMK-6L	6553
Trim Ring Mount Kit (Accessory)	-	TMK-6L	6554
-	Wall Mount Kit – Mud Ring	WMKM-6L	6553
-	Wall Mount Kit – Trim Ring	WMKT-6L	6554
	Wall Mount Kit – Bracket	WMKB-6L	Not Applicable

NOTE: Pre-construction refers to framed walls prior to hanging drywall. Post-construction refers to framed walls with drywall hung.

NOTE: There is also a rack mount kit (RMK-6L) available for the TPS-6L. Refer to the latest version of the RMK-6L Installation Guide (Doc. 6599).

If the BB-6L or PMK-6L are to be used and a touchpanel is not available, the installer can either leave the hole in the mounting surface open (if permitted by local building codes) or attach the cover plate supplied with the mounting kit.

Touchpanel Mounting

Physical installation of the TPS-6L without a mounting option includes mounting the unit to the wall and installing a bezel. The only tools required for the procedures presented here are masking tape (or equivalent), a level, a gypsum board saw (or equivalent), and a #2 Phillips tip screwdriver. The following procedures are based on the use of the supplied screws and clips for post-construction installation.

Mounting to the Wall

The TPS-6L is designed to be mounted in a wall or lectern. Two overlay cutout templates (4504078) are supplied. One is in the shape of the required opening; the other is similar to a frame, with the inner area of the frame the shape of the required opening. (Refer to the following diagrams.) Use the template that is most convenient.

Mounting Parts Supplied with the TPS-6L

PART DESCRIPTION	PART NUMBER	QUANTITY
Metal Mounting Clip	2014237	4
Overlay Template Cutout	4504078	1
Connector Plug, Three-pin	2003575	1
Connector Plug, Four-pin	2003576	1
Connector Plug, Five-pin	2003577	2
Screw, #04-40 x 2", Pan Head*	2018793	4
Screw, #6AB x 2-1/2", Pan Head	2014276	4

* Used for mounting the optional external speaker SPK-6L.

NOTE: The following drawings are not to scale. Do not attempt to use them to prepare the hole in the mounting surface.

TPS-6L Cutout Dimensions (4504078, 1 of 2)

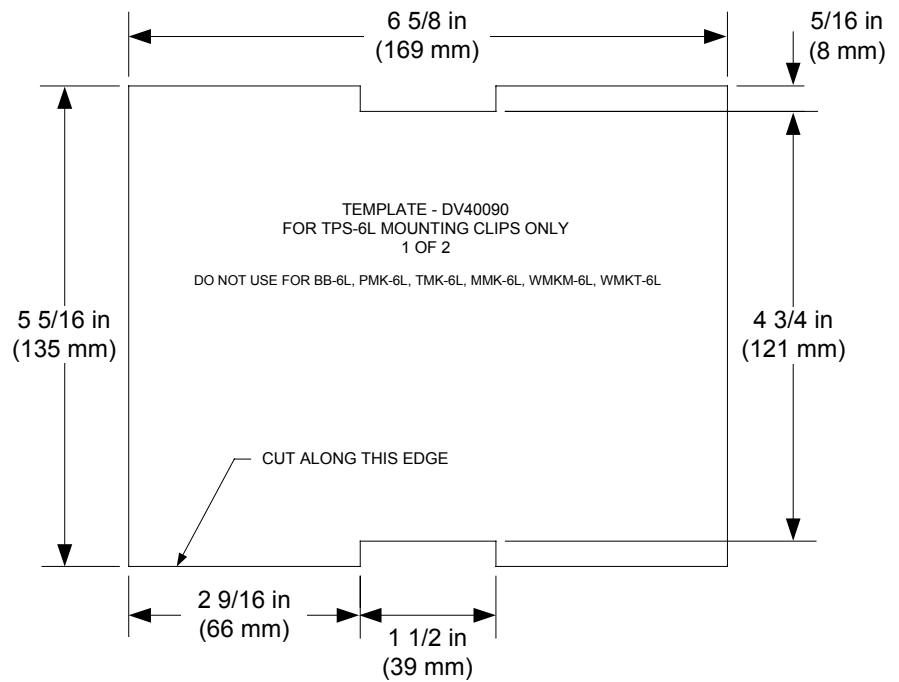

TPS-6L Cutout Dimensions (4504078, 2 of 2)

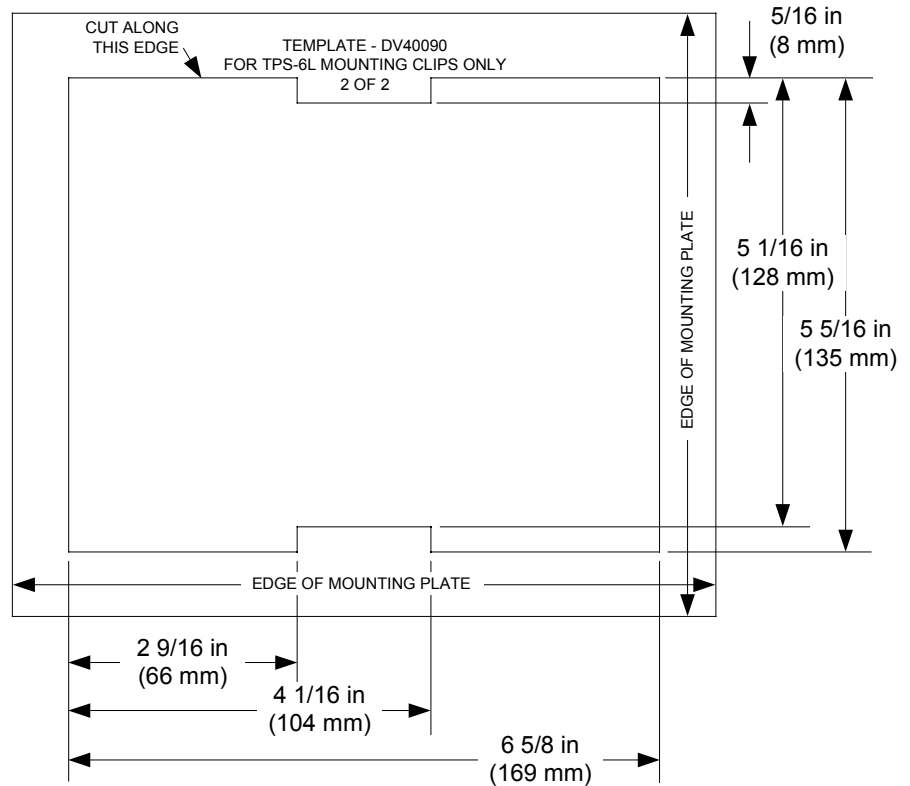

1. Locate an area on the wall that is free of miscellaneous wiring and studs.
2. Make a small hole near the middle of the designated site, and verify that the location is suitable.

3. Using masking tape (or equivalent), fasten the template to the wall; verify that the template is level, and trace the opening shape on the wall.
4. Remove the template, and then cut out and remove the traced shape to produce the required opening.

NOTE: Before inserting the TPS-6L in the mounting hole, ensure that all required cables have been installed in the wall.

5. Install the four supplied #6 x 2-1/2" screws and mounting clips as shown in the following diagram (two on the top and two on the bottom).
 - Insert the screws through the touchpanel flange and then through the larger hole in the mounting clip.
 - Thread the screws through the smaller hole in the mounting clips and tighten the screws only enough that the mounting clips are brought flush with the rear of the touchpanel flange. Do not compress the mounting clips at this time.

Attaching the Screws and Mounting Clips

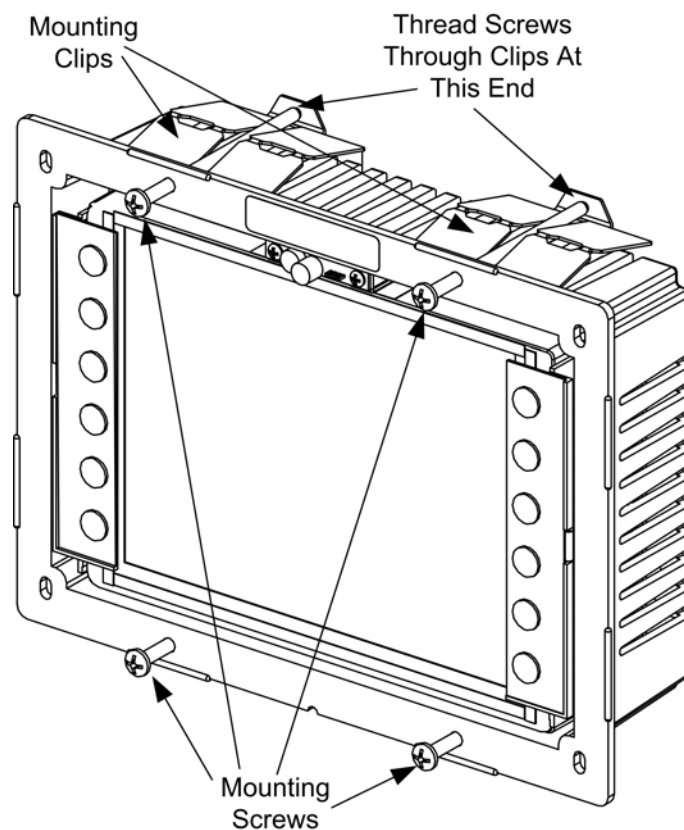

6. Connect the Cresnet cable, using the supplied mating connector, to the Cresnet port; attach the Ethernet cable, if required; attach all other cables (audio and video); and, if included, connect and attach the optional external speaker kit (SPK-6L); and position the TPS-6L in the mounting hole. Refer to "Hardware Hookup" which starts on page 34.

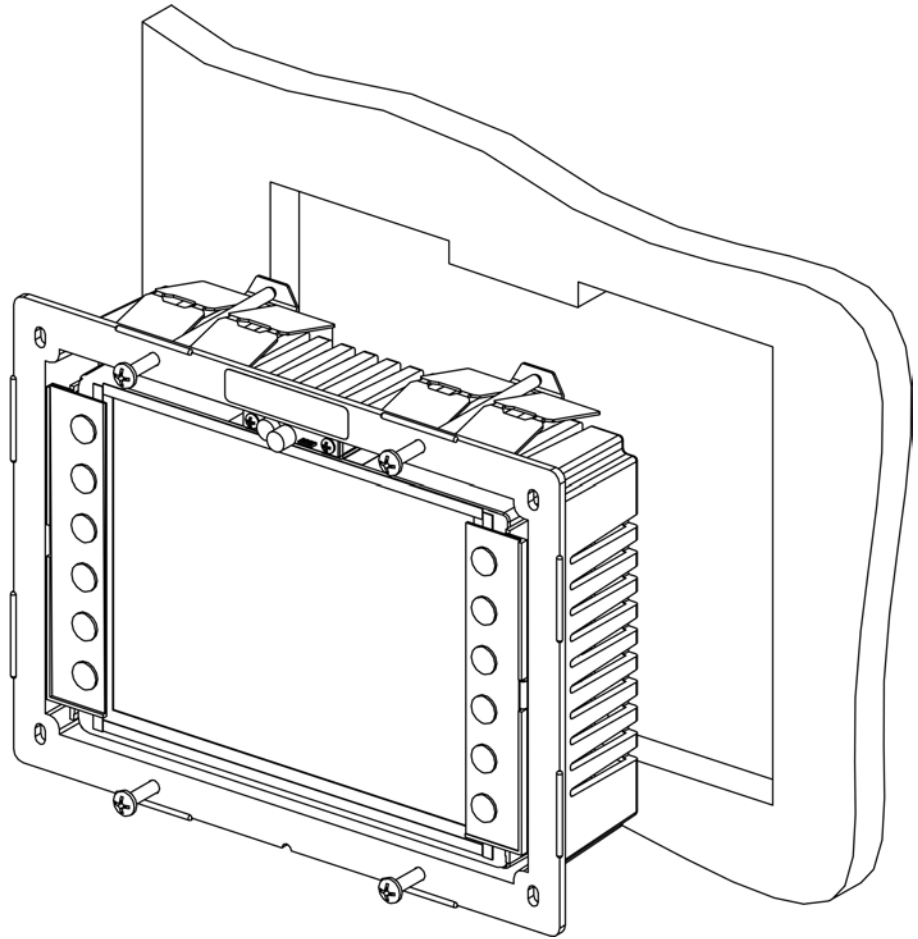
Insert the TPS-6L Into the Mounting Surface

7. Tighten the mounting screws evenly and only enough to compress the mounting clips and secure the TPS-6L squarely in the mounting surface. Do not over-tighten the screws.

NOTE: If it becomes necessary to remove the touchpanel from the mounting surface, the original mounting clips cannot be reused to remount the touchpanel. Additional mounting clips are available in the Mounting Kit WMKB-6L identified in “Mounting Options” on page 29.

Installing the Bezel

Use the Crestron Engraver software package to obtain a custom-engraved bezel for the TPS-6L. Install the bezel as follows.

1. Carefully position the bezel over the face of the touchpanel.
2. Ensure that the bezel is oriented properly and press against the TPS-6L until the bezel snaps into place.

Touchpanel Removal

If it is necessary to remove the touchpanel after it has been installed into a mounting surface, complete the following steps in the order provided to remove the touchpanel. The only tool required is a #2 Phillips tip screwdriver.

1. Lift one edge of the bezel to free it from the touchpanel, and lift it off. Do not apply excessive pressure to the touchscreen.
2. Loosen and remove the screws that secure touchpanel to the mounting option in use.
3. Using equal pressure, carefully remove the touchpanel from the opening.

If necessary, secure and label the attached cables before disconnecting them from the back of the touchpanel.

Hardware Hookup

Ventilation

The TPS-6L should be used in a well-ventilated area. The venting holes should not be obstructed under any circumstances. If the TPS-6L is hot to the touch, consider used forced air ventilation.

To prevent overheating, do not operate this product in an area that exceeds the environmental temperature range listed in the table of specifications. Consideration must be given if installed in a closed or multi-unit rack assembly since the operating ambient temperature of the environment may be greater than the room ambient temperature. Contact with thermal insulating materials should be avoided on all sides of the unit.

Connect the Device

Make the necessary connections as called out in the illustration that follows this paragraph. Refer to “Network Wiring” on page 12 before attaching the 4-position terminal block connector. Apply power after all connections have been made.

When making connections to the TPS-6L, use Crestron power supplies for Crestron equipment.

Hardware Connections for the TPS-6L

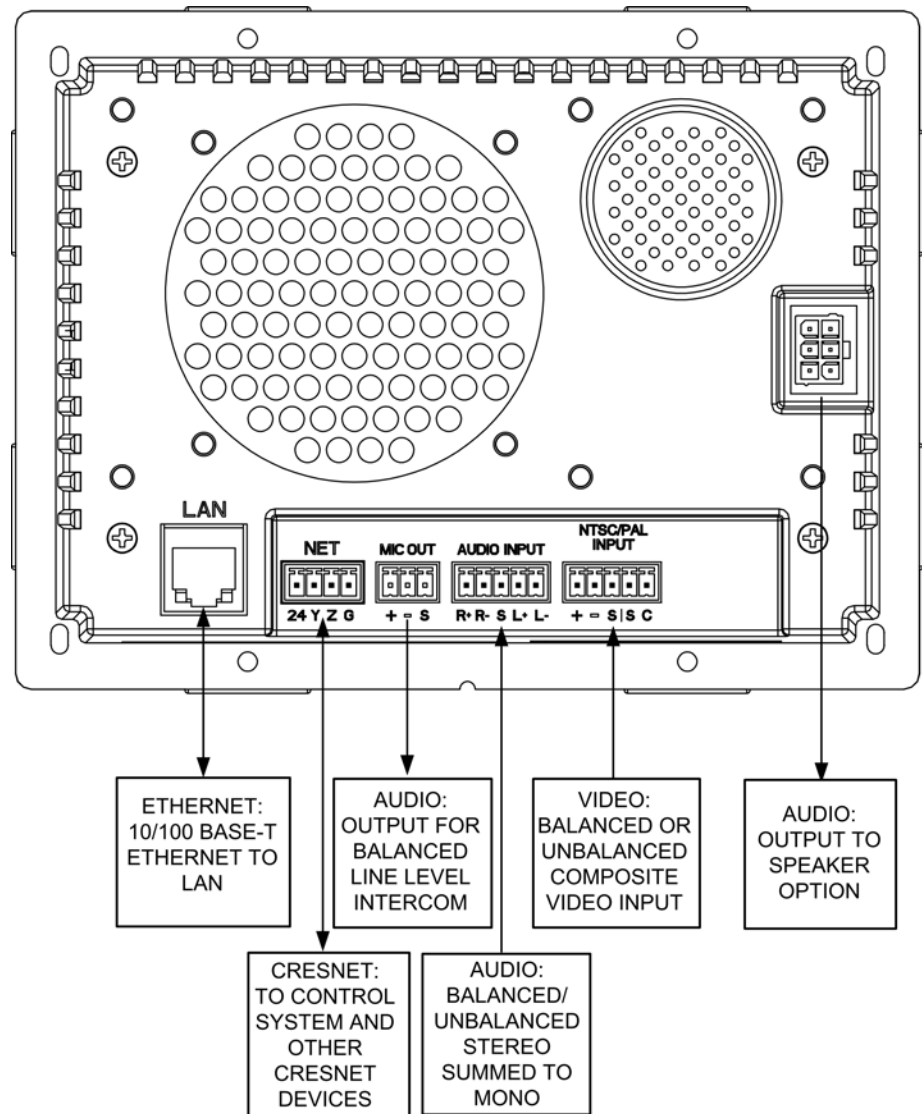

CAUTION: Do not apply excessive pressure to the touchscreen display during handling. Doing so can crack the screen and damage the touchpanel.

NOTE: The TPS-6L can only be powered via the 4-position terminal block connector labeled **NET**. Power cannot be supplied from network devices that are connected to the mini-terminal block connectors.

Recommended Cleaning

Keep the surface of the touchscreen free of dirt, dust or other materials that could degrade optical properties. Long-term contact with abrasive materials can scratch the surface, which may detrimentally affect image quality.

For best cleaning results use a clean, damp, non-abrasive cloth with any commercially available non-ammonia glass cleaner. Bezels may not provide a complete watertight seal. Therefore, apply cleaning solution to the cloth rather than the surface of the touchscreen. Wipe touchscreen clean and avoid getting moisture beneath the bezels.

Programming Software

Have a question or comment about Crestron software?

Answers to frequently asked questions (FAQs) can be viewed in the Online Help section of the Crestron website. To post a question or view questions you have submitted to Crestron's True Blue Support, log in at <http://support.crestron.com>. First-time users will need to establish a user account.

Earliest Version Software Requirements for the PC

NOTE: Crestron recommends that you use the latest software to take advantage of the most recently released features. The latest software is available from the Crestron website.

Crestron has developed an assortment of Windows®-based software tools to develop a Cresnet system. For the minimum recommended software versions, visit the Version Tracker page of the Crestron website (www.crestron.com/versiontracker).

Programming with Crestron SystemBuilder

Crestron SystemBuilder is the easiest method of programming but does not offer as much flexibility as SIMPL Windows. For additional details, download SystemBuilder from the Crestron website and examine the extensive help file.

Programming with D3 Pro

Crestron's D3 Pro lighting software provides all the tools necessary to create a complete Crestron lighting system for residential applications. The lighting system includes the control system logic program, touchpanel projects and keypad programming, documentation and real-time lighting adjustment capabilities.

As with all Crestron software, D3 Pro provides extensive right-click and drag-and-drop functionality in addition to convenient keyboard shortcuts for frequently used functions and commands.

Programming is organized into six system **Views** of the lighting system, each providing a moveable toolbox of devices such as interfaces, fixtures and control modules. You can add a device to your system simply by selecting it from one of the toolboxes and dragging it to a room. The available toolboxes differ depending on the View but all Views include a "General" toolbox that allows you to add areas and rooms at any time.

Programming with SIMPL Windows

NOTE: While SIMPL Windows can be used to program the TPS-6L, it is recommended to use SystemBuilder for configuring a system.

SIMPL Windows is Crestron's premier software for programming Crestron control systems. It is organized into two separate but equally important "Managers".

Configuration Manager

Configuration Manager is the view where programmers “build” a Crestron control system by selecting hardware from the *Device Library*.

- To incorporate the TPS-6L into the system, drag the TPS-6L from the Touchpanels | Touchpanels (Cresnet) folder (or the Touchpanels (Ethernet) folder) of the *Device Library* and drop it in the *System Views*.

Locating the TPS-6L in the Device Library

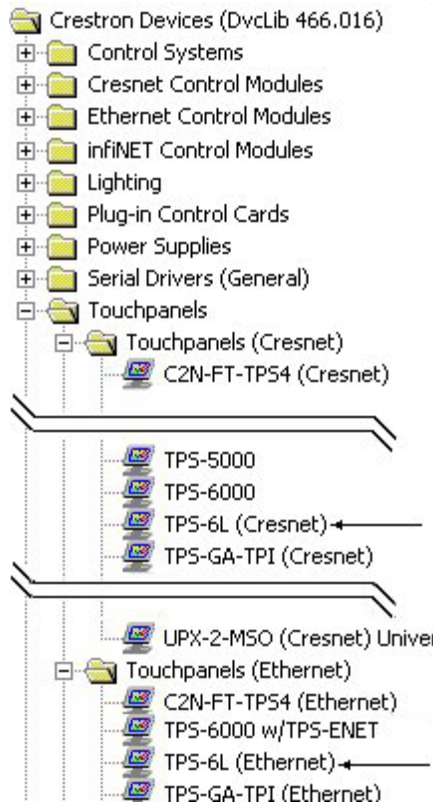

- The system tree of the control system displays the device in the appropriate slot(s) with a default Net ID and default IP ID as shown in the following illustration.

C2Net Device, Slots 8 and 9

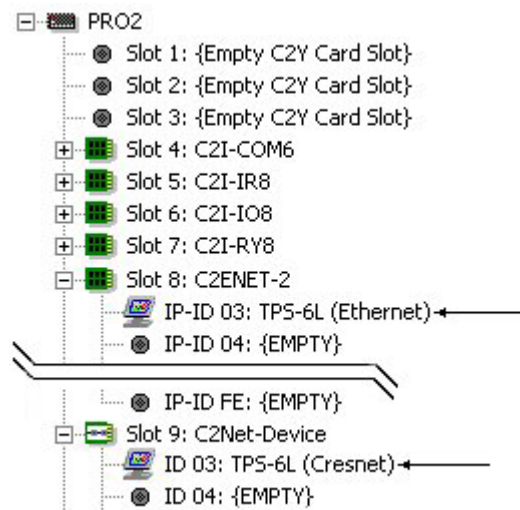

- Additional TPS-6L devices are assigned different Net ID (for Cresnet devices) or IP ID (for Ethernet devices) numbers as they are added.
- If necessary, double click a device to open the “Device Settings” window and change the Net ID or IP ID, as shown in the following figures.

“TPS-6L Device Settings” Net ID Window

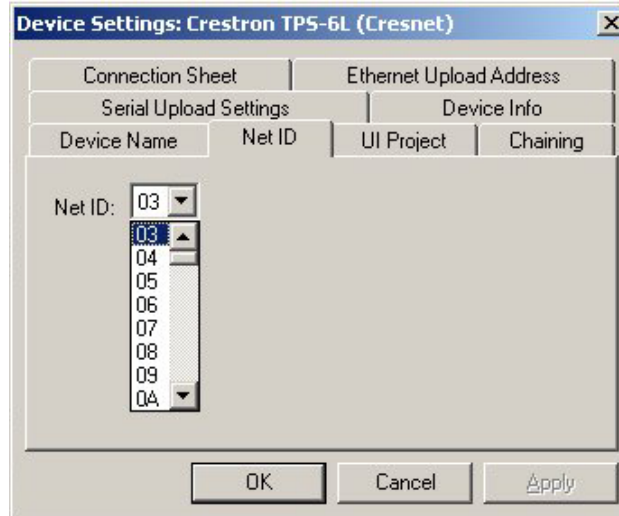

“TPS-6L Device Settings” IP ID Window

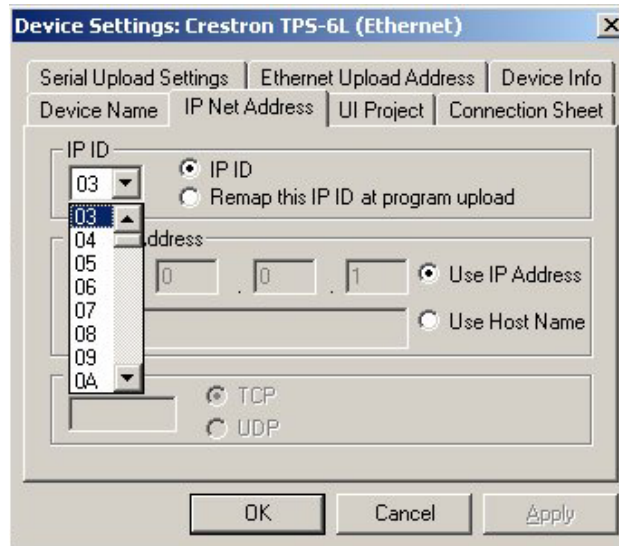

- The ID code specified in the SIMPL Windows program must match the Net ID or IP ID of each unit. Refer to “Identity Code” on page 12.

Program Manager

Program Manager is the view where programmers “program” a Crestron control system by assigning signals to symbols.

The symbol can be viewed by double clicking on the icon or dragging it into *Detail View*. Each signal in the symbol is described in the SIMPL Windows help file (F1).

Programming with VisionTools Pro-e

Touchpanel screens should be created in VisionTools Pro-e to allow switching of source signals to desired outputs as well as selection of the system mode. There are no special programming requirements to use the functions of the TPS-6L in a room-control system.

Multi-Mode Objects

Multi-mode objects offer high-performance programming!

The single most-advanced VisionTools Pro-e high-performance programming technique involving the TPS-6L is the concept of multi-mode objects. A multi-mode object (i.e. button, legend, etc.) is an object drawn on a VisionTools Pro-e page that can have one or more active and inactive visible settings (*modes*).

For examples, refer to www.crestron.com/exampleprograms and search for multi-mode object examples. This file contains the VisionTools Pro-e touchpanel files and SIMPL Windows files that illustrate the high-performance capabilities of multi-mode objects.

WAV File Audio Messages

The TPS-6L touchpanels are capable of playing audio messages as system prompts and responses. These files are recorded as WAV files on a PC using an audio utility such as Sound Recorder that is packaged with Microsoft Windows 95/98/Me/XP/NT/2000/Vista™. Files from other sources may also be converted to an acceptable format by using this or a similar utility. Many other audio utilities are available commercially or as shareware. The TPS-6L touchpanels only accept the following WAV file format: **PCM, 8 kHz, mono, 8-bit**. For more information about how to use Sound Recorder, refer to its User's Guide and extensive help information provided with the software. Also refer to the help file in VisionTools Pro-e to learn how to use its audio tool, Sound Manager, to attach WAV files to a touchpanel project.

Pre-recorded WAV files for voice prompts and responses are available from Crestron. These files can be stored into and programmed for use in the touchpanel directly or may be edited with the Sound Recorder. For example, the individual files can be combined to create custom messages.

NOTE: Touchpanel WAV files can be obtained from the Wave LC Library of the Crestron FTP site.

Bit Depth and File Size

A bit depth refers to the number of memory bits used to store color data for each pixel in a raster image. A touchpanel raster image consists of a rectangular grid of picture elements (pixels). Each pixel uses the same amount of memory to store its color data. The amount of memory is called the bit depth of the image.

Greater bit depths are required to represent finer gradations of color. Increasing bit depth necessarily increases file size. A black and white drawing requires only one bit per pixel to store all the available color information. Using a 32-bit per pixel bit depth for a black and white image increases the file size 32 times without adding anything to the black and white image quality.

In an 8-bit per pixel system, the associated 8-bits of video memory for every screen pixel contain a value referring to a location in an 8-bit color table. In this way any one of the specific 256 color table locations is assigned to a pixel.

A 16-bit highcolor system is considered sufficient to provide life-like colors. It is encoded using 5-bits to represent red, 5-bits to represent blue and (since the human

eye is more sensitive to the color green) 6-bits to represent 64 levels of green. These can therefore be combined to provide 65,536 mixed colors ($32 \times 32 \times 64 = 65,536$).

In a 24-bit graphics display, the video memory allocates 24 bits for each pixel on the screen enabling each pixel to take on any one of a possible 16.7 million colors. Each 24-bit value is composed of 8-bits for red, 8-bits for green and 8-bits for blue. These triplets of 8-bit values are also referred to as the red, green and blue color planes. A 24-bit image is actually composed of three component images, which combine to create the truecolor picture. The reason this is called truecolor is that this is near the maximum number of colors the human eye is able to detect.

Truecolor images are sometimes represented by a 32-bit value. The extra 8-bits do not enhance the precision of the color representation but act as an alpha channel that represents pixel translucence. The 32-bit truecolor has become popular on the computer desktop to provide effects such as translucent windows, fading menus and shadows.

In graphics intensive applications such as touchpanels, raising or lowering the color depth of the displayed graphics can achieve a balance of performance and quality. Lower color depths do not require as much frame buffer memory or display bandwidth, allowing them to be generated and displayed more quickly. Increasing color depth results in higher color quality at the expense of display speed and responsiveness. By using mostly 8-bit or 16-bit graphics and holding the 32-bit graphics to a minimum (e.g. for a family photo, etc.), you can create a sophisticated project that will fit in the memory space provided and have the touchpanel remain very responsive.

Relationship of Bits to Colors

NUMBER OF BITS	NUMBER OF COLORS
1 bit	Black and White
2 bits	4 Colors
4 bits	16 Colors
8 bits	256 Colors
16 bits	65,536 Colors (Highcolor)
24 bits	16.7 million Colors (Truecolor)
32 bits	16.7 million Colors plus Transparency

When creating a VisionTools Pro-e project you can elect to compress and reduce the image size in the "Page Properties" window for the entire page and/or perform the same function of reducing the image size using the "Image Properties" window. A reduction in image size will save a considerable amount of memory space for your project.

In VisionTools Pro-e, the **Compress** checkbox permits the image to be compressed when compiling. The **16 Bits** checkbox converts a 24-bit or 32-bit image to 16 bits. This conversion to a 16-bit image may cause the loss of some subtle shading. To compensate for this, use the dithering to simulate the original shading. Various dithering types are available. Refer to the following illustrations.

VT Pro-e “Page Properties” Window – Bit Depth Selection

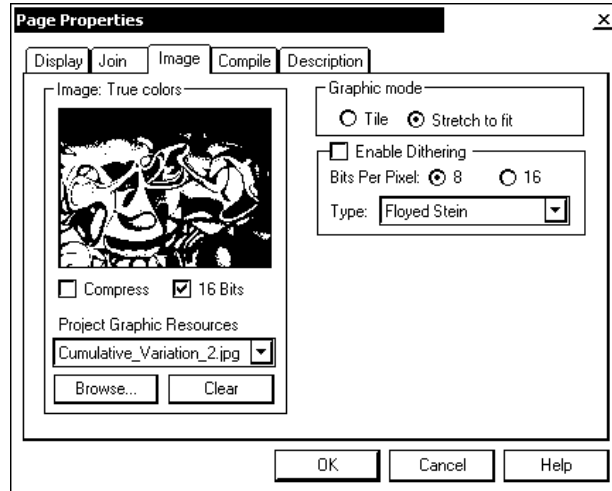

VT Pro-e “Image Properties” Window – Bit Depth Selection

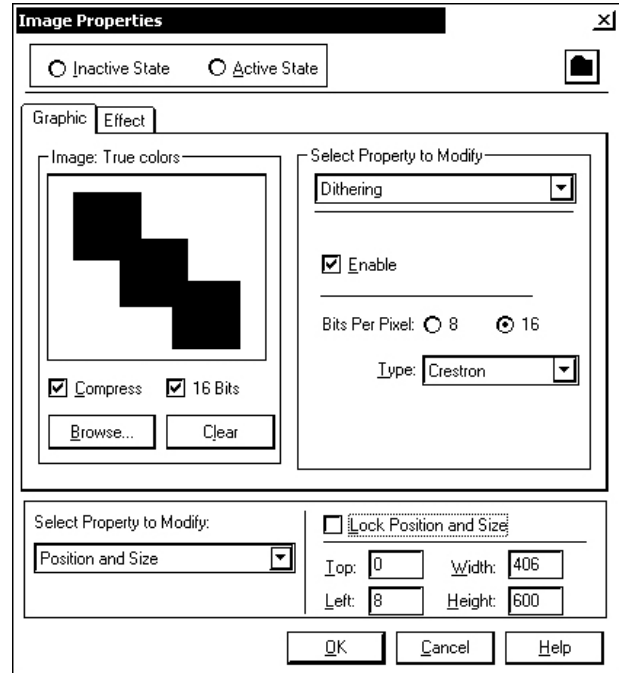

Pushbutton Programming

The twelve pushbuttons that flank the display can be programmed to access any frequently used command. Each button has a permanently fixed digital join number. The sequence of digital join numbers is (top to bottom, left to right) 1 through 6 and 7 through 12. Refer to the following illustration. A description for each button signal is given in the SIMPL Windows help file (F1).

Pushbutton Layout and Join Number Assignment

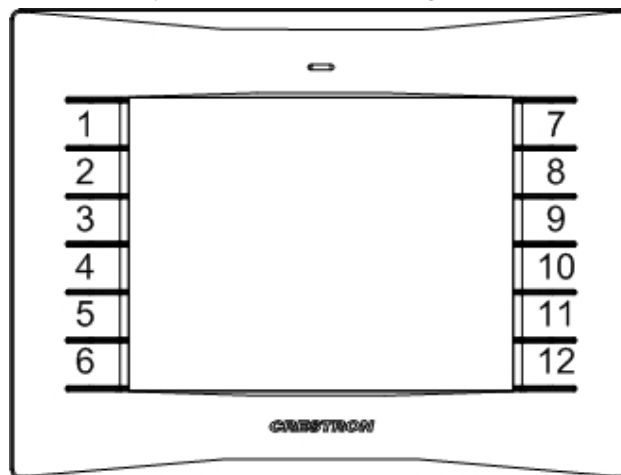

MultiByte International Characters

Most languages use a single byte of eight bits to represent a character, e.g. English, French, German, Hebrew, Russian, Thai, etc.

Multibyte character fonts require more than the usual eight bits to specify a character. This occurs when a language has more than 256 characters (2⁸) in a font.

For example, Chinese fonts contain several thousand characters. Other multibyte languages include Japanese and Korean.

There are two separate applications with multibyte characters – static text on buttons and indirect text on buttons. No Isys touchpanel firmware changes are required in either case.

Indirect text on a button is entered in VisionTools Pro-e and the actual string to be displayed is entered in SIMPL Windows. As of this publication date only completely single byte or completely multibyte strings may be entered or they will not be compiled correctly in SIMPL Windows. In other words, you cannot enter Chinese characters interspersed with numbers. You can enter Chinese characters or numbers in separate strings or you can pad each number with “\x00” to make it multibyte and then combine it with Chinese characters in the same string.

Of course you can always use the workaround of showing a graphic that displays the string but it is not dynamic. To compile and use multibyte characters it is essential that the operating system understand the language. Windows XP is available in many international languages and add-on software is available for other versions of Windows.

Example Program

An example program for the TPS-6L is available from the Crestron website (www.crestron.com/exampleprograms).

Uploading and Upgrading

Crestron recommends using the latest programming software and that each device contains the latest firmware to take advantage of the most recently released features. However, before attempting to upload or upgrade it is necessary to establish communication. Once communication has been established, files (for example, programs, projects or firmware) can be transferred to the control system (and/or device). Finally, program checks can be performed (such as changing the device ID or creating an IP table) to ensure proper functioning.

Establishing Communication

Use Crestron Toolbox for communicating with the TPS-6L; refer to the Crestron Toolbox help file for details. There are two methods of communication.

Indirect

Indirect Communication

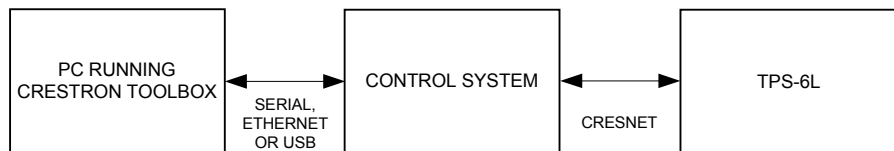

- TPS-6L connects to control system via Cresnet.
- Establish communication between the PC and the control system as described in the latest version of the 2-Series Control Systems Reference Guide (Doc. 6256).
- Use the Address Book in Crestron Toolbox to create an entry for the TPS-6L using the expected communication protocol (Indirect). Select the Cresnet ID of the TPS-6L and the address book entry of the control system that is connected to the TPS-6L.
- Display the TPS-6L's "System Info" window (click the  icon); communications are confirmed when the device information is displayed.

TCP/IP

NOTE: Required for operation with a Crestron control system.

Ethernet Communication



- Establish indirect communication between TPS-6L and PC as stated above.
- Enter the IP address, IP mask and default router of the TPS-6L via the Crestron Toolbox (**Functions | Ethernet Addressing**); otherwise enable DHCP.
- Confirm Ethernet connections between TPS-6L and PC. If connecting through a hub or router, use CAT5 straight through cables with 8-pin RJ-45 connectors. Alternatively, use a CAT5 crossover cable to connect the two **LAN** ports directly without using a hub or router.

- Use the Address Book in the Crestron Toolbox to create an entry for the TPS-6L with the TPS-6L's TCP/IP communication parameters.
- Display the "System Info" window (click the  icon) and select the TPS-6L entry.

Programs, Projects and Firmware

Program, project or firmware files may be distributed from programmers to installers or from Crestron to dealers. Firmware upgrades are available from the Crestron website as new features are developed after product releases. One has the option to upload programs and projects via the programming software or to upload and upgrade via the Crestron Toolbox. For details on uploading and upgrading, refer to the SIMPL Windows help file, VisionTools Pro-e help file or the Crestron Toolbox help file.

SIMPL Windows

If a SIMPL Windows program is provided, it can be uploaded to the control system using SIMPL Windows or Crestron Toolbox.

VisionTools Pro-e

Upload the VisionTools Pro-e file to the touchpanel using VisionTools Pro-e or Crestron Toolbox.

Firmware

Check the Crestron website to find the latest firmware. (New users may be required to register to obtain access to certain areas of the site, including the FTP site.)

- Upgrade TPS-6L firmware via Crestron Toolbox.
- Establish communication with the TPS-6L and display the "System Info" window.
- Select **Functions | Firmware...** to upgrade the TPS-6L firmware.

Program Checks

Actions that can be performed on the TPS-6L vary depending on whether it is connected via Cresnet or Ethernet.

Cresnet Connections

For Cresnet connections, using Crestron Toolbox, display the network device tree (**Tools | Network Device Tree**) to show all network devices connected to the control system. Right-click on the TPS-6L to display actions that can be performed on the TPS-6L.

Ethernet Connections

For Ethernet connections, display the "System Info window (click the  icon) and select the **Functions** menu to display actions that can be performed on the TPS-6L.

Be sure to use the Crestron Toolbox to create the TPS-6L IP table.

- Select **Functions | IP Table Setup**.
- Add, modify or delete entries in the IP table. The TPS-6L can have only one IP table entry.
- A defined IP table can be saved to a file or sent to the device.

Edit the control system's IP table to include an entry for the TPS-6L. The entry should list the TPS-6L's IP ID (specified on the TPS-6L's IP table) and the internal gateway IP address 127.0.0.1.

Problem Solving

Troubleshooting

The following table provides corrective action for possible trouble situations. If further assistance is required, please contact a Crestron customer service representative.

TPS-6L Troubleshooting

TROUBLE	POSSIBLE CAUSE(S)	CORRECTIVE ACTION
TPS-6L not functioning.	Net ID is not correct.	Verify the Net ID In Crestron Toolbox.
	Net ID is not set to match the Net ID specified in SIMPL Windows.	Verify SIMPL Windows program for setting Net IDs.
	Net ID is the same as another device's Net ID.	Assign a different Net ID.
Buttons do not function when pressed.	Net ID incorrect or does not match SIMPL Windows program.	In Crestron Toolbox, check Functions CresnetID to verify Net ID. Verify SIMPL Windows program ID.
Button press yields incorrect result.	Incorrect programming.	Verify SIMPL Windows program.
Unexpected response from the touchpanel.	Touchpanel is incorrectly calibrated.	Enter "SETUP MODE" or use Crestron Toolbox to initiate the calibration sequence and recalibrate.
Communications via the LAN port is not functioning.	Improper Ethernet connection (IEC).	Verify proper connection at touchpanel LAN port.
	Incorrect touchpanel selected in SIMPL Windows.	Select "Touchpanel (Ethernet)" instead of "Touchpanel (Cresnet)".
	Another device set to the same IP address.	Obtain new touchpanel static IP address.
	Possible bad port on the hub.	Use crossover cable to connect directly to the Ethernet port on a PC and ping the IP address of the touchpanel to confirm communication. If it is good, confirm hub port by testing with another Ethernet device.

Check Network Wiring

Use the Right Wire

In order to ensure optimum performance over the full range of your installation topology, Crestron Certified Wire and only Crestron Certified Wire may be used. Failure to do so may incur additional charges if support is required to identify performance deficiencies because of using improper wire.

Calculate Power

CAUTION: Use only Crestron power supplies for Crestron equipment. Failure to do so could cause equipment damage or void the Crestron warranty.

CAUTION: Provide sufficient power to the system. Insufficient power can lead to unpredictable results or damage to the equipment. Please use the Crestron Power Calculator to help calculate how much power is needed for the system (www.crestron.com/calculators).

When calculating the length of wire for a particular Cresnet run, the wire gauge and the Cresnet power usage of each network unit to be connected must be taken into consideration. Use Crestron Certified Wire only. If Cresnet units are to be daisy-chained on the run, the Cresnet power usage of each network unit to be daisy-chained must be added together to determine the Cresnet power usage of the entire chain. If the unit is home-run from a Crestron system power supply network port, the Cresnet power usage of that unit is the Cresnet power usage of the entire run. The wire gauge and the Cresnet power usage of the run should be used in the following equation to calculate the cable length value on the equation's left side.

Cable Length Equation

$$L < \frac{40,000}{R \times P}$$

<p>Where: L = Length of run (or chain) in feet R = 6 Ohms (Crestron Certified Wire: 18 AWG (0.75 MM²)) or 1.6 Ohms (Cresnet HP: 12 AWG (4 MM²)) P = Cresnet power usage of entire run (or chain)</p>

Make sure the cable length value is less than the value calculated on the right side of the equation. For example, a Cresnet run using 18 AWG Crestron Certified Wire and drawing 20 watts should not have a length of run more than 333 feet. If Cresnet HP is used for the same run, its length could extend to 1250 feet.

NOTE: All Crestron certified Cresnet wiring must consist of two twisted pairs. One twisted pair is the +24V conductor and the GND conductor and the other twisted pair is the Y conductor and the Z conductor.

Strip and Tin Wire

When daisy-chaining Cresnet units, strip the ends of the wires carefully to avoid nicking the conductors. Twist together the ends of the wires that share a pin on the network connector and tin the twisted connection. Apply solder only to the ends of the twisted wires. Avoid tinning too far up the wires or the end becomes brittle. Insert the tinned connection into the Cresnet connector and tighten the retaining screw. Repeat the procedure for the other three conductors.

Add Hubs

For larger networks (i.e., greater than 28 network devices), it may become necessary to add a Cresnet Hub/Repeater (CNXHUB) to maintain signal quality throughout the network. Also, for networks with lengthy cable runs it may be necessary to add a Hub/Repeater after only 20 devices.

Reference Documents

The latest version of all documents mentioned within the guide can be obtained from the Crestron website (www.crestron.com/manuals). This link will provide a list of product manuals arranged in alphabetical order by model number.

List of Related Reference Documents

DOCUMENT TITLE
2-Series Control Systems Reference Guide
BB-6L Back Box Kit
CAT5 Reference Guide
Crestron e-Control® Reference Guide
MMK-6L and WMKM-6L Mud Ring Mount Kit
PMK-6L Pre-Construction Mount Kit
RMK-6L Rack Mount Kit
TMK-6L and WMKT-6L Trim Ring Mount Kit
Touchpanel Mounting Quick Start guide

Further Inquiries

If you cannot locate specific information or have questions after reviewing this guide, please take advantage of Crestron's award winning customer service team by calling Crestron at 1-888-CRESTRON [1-888-273-7876].

You can also log onto the online help section of the Crestron website (www.crestron.com/onlinehelp) to ask questions about Crestron products. First-time users will need to establish a user account to fully benefit from all available features.

Future Updates

As Crestron improves functions, adds new features and extends the capabilities of the TPS-6L, additional information may be made available as manual updates. These updates are solely electronic and serve as intermediary supplements prior to the release of a complete technical documentation revision.

Check the Crestron website periodically for manual update availability and its relevance. Updates are identified as an “Addendum” in the Download column.

Software License Agreement

This License Agreement (“Agreement”) is a legal contract between you (either an individual or a single business entity) and Crestron Electronics, Inc. (“Crestron”) for software referenced in this guide, which includes computer software and as applicable, associated media, printed materials and “online” or electronic documentation (the “Software”).

BY INSTALLING, COPYING OR OTHERWISE USING THE SOFTWARE, YOU REPRESENT THAT YOU ARE AN AUTHORIZED DEALER OF CRESTRON PRODUCTS OR A CRESTRON AUTHORIZED INDEPENDENT PROGRAMMER AND YOU AGREE TO BE BOUND BY THE TERMS OF THIS AGREEMENT. IF YOU DO NOT AGREE TO THE TERMS OF THIS AGREEMENT, DO NOT INSTALL OR USE THE SOFTWARE.

IF YOU HAVE PAID A FEE FOR THIS LICENSE AND DO NOT ACCEPT THE TERMS OF THIS AGREEMENT, CRESTRON WILL REFUND THE FEE TO YOU PROVIDED YOU (1) CLICK THE DO NOT ACCEPT BUTTON, (2) DO NOT INSTALL THE SOFTWARE AND (3) RETURN ALL SOFTWARE, MEDIA AND OTHER DOCUMENTATION AND MATERIALS PROVIDED WITH THE SOFTWARE TO CRESTRON AT: CRESTRON ELECTRONICS, INC., 15 VOLVO DRIVE, ROCKLEIGH, NEW JERSEY 07647, WITHIN 30 DAYS OF PAYMENT.

LICENSE TERMS

Crestron hereby grants You and You accept a nonexclusive, nontransferable license to use the Software (a) in machine readable object code together with the related explanatory written materials provided by Crestron (b) on a central processing unit (“CPU”) owned or leased or otherwise controlled exclusively by You and (c) only as authorized in this Agreement and the related explanatory files and written materials provided by Crestron.

If this software requires payment for a license, you may make one backup copy of the Software, provided Your backup copy is not installed or used on any CPU. You may not transfer the rights of this Agreement to a backup copy unless the installed copy of the Software is destroyed or otherwise inoperable and You transfer all rights in the Software.

You may not transfer the license granted pursuant to this Agreement or assign this Agreement without the express written consent of Crestron.

If this software requires payment for a license, the total number of CPU’s on which all versions of the Software are installed may not exceed one per license fee (1) and no concurrent, server or network use of the Software (including any permitted back-up copies) is permitted, including but not limited to using the Software (a) either directly or through commands, data or instructions from or to another computer (b) for local, campus or wide area network, internet or web hosting services or (c) pursuant to any rental, sharing or “service bureau” arrangement.

The Software is designed as a software development and customization tool. As such Crestron cannot and does not guarantee any results of use of the Software or that the Software will operate error free and You acknowledge that any development that You perform using the Software or Host Application is done entirely at Your own risk.

The Software is licensed and not sold. Crestron retains ownership of the Software and all copies of the Software and reserves all rights not expressly granted in writing.

OTHER LIMITATIONS

You must be an Authorized Dealer of Crestron products or a Crestron Authorized Independent Programmer to install or use the Software. If Your status as a Crestron Authorized Dealer or Crestron Authorized Independent Programmer is terminated, Your license is also terminated.

You may not rent, lease, lend, sublicense, distribute or otherwise transfer or assign any interest in or to the Software.

You may not reverse engineer, decompile or disassemble the Software.

You agree that the Software will not be shipped, transferred or exported into any country or used in any manner prohibited by the United States Export Administration Act or any other export laws, restrictions or regulations (“Export Laws”). By downloading or installing the Software You (a) are certifying that You are not a national of Cuba, Iran, Iraq, Libya, North Korea, Sudan, Syria or any country to which the United States embargoes goods (b) are certifying that You are not otherwise prohibited from receiving the Software and (c) You agree to comply with the Export Laws.

If any part of this Agreement is found void and unenforceable, it will not affect the validity of the balance of the Agreement, which shall remain valid and enforceable according to its terms. This Agreement may only be modified by a writing signed by an authorized officer of Crestron. Updates may be licensed to You by Crestron with additional or different terms. This is the entire agreement between Crestron and You relating to the Software and it supersedes any prior representations, discussions, undertakings, communications or advertising relating to the Software. The failure of either party to enforce any right or take any action in the event of a breach hereunder shall constitute a waiver unless expressly acknowledged and set forth in writing by the party alleged to have provided such waiver.

If You are a business or organization, You agree that upon request from Crestron or its authorized agent, You will within thirty (30) days fully document and certify that use of any and all Software at the time of the request is in conformity with Your valid licenses from Crestron or its authorized agent.

Without prejudice to any other rights, Crestron may terminate this Agreement immediately upon notice if you fail to comply with the terms and conditions of this Agreement. In such event, you must destroy all copies of the Software and all of its component parts.

PROPRIETARY RIGHTS

Copyright. All title and copyrights in and to the Software (including, without limitation, any images, photographs, animations, video, audio, music, text and “applets” incorporated into the Software), the accompanying media and printed materials and any copies of the Software are owned by Crestron or its suppliers. The Software is protected by copyright laws and international treaty provisions. Therefore, you must treat the Software like any other copyrighted material, subject to the provisions of this Agreement.

Submissions. Should you decide to transmit to Crestron’s website by any means or by any media any materials or other information (including, without limitation, ideas, concepts or techniques for new or improved services and products), whether as information, feedback, data, questions, comments, suggestions or the like, you agree such submissions are unrestricted and shall be deemed non-confidential and you automatically grant Crestron and its assigns a non-exclusive, royalty-free, worldwide, perpetual, irrevocable license, with the right to sublicense, to use, copy, transmit, distribute, create derivative works of, display and perform the same.

Trademarks. CRESTRON and the Swirl Logo are registered trademarks of Crestron Electronics, Inc. You shall not remove or conceal any trademark or proprietary notice of Crestron from the Software including any back-up copy.

GOVERNING LAW

This Agreement shall be governed by the laws of the State of New Jersey, without regard to conflicts of laws principles. Any disputes between the parties to the Agreement shall be brought in the state courts in Bergen County, New Jersey or the federal courts located in the District of New Jersey. The United Nations Convention on Contracts for the International Sale of Goods shall not apply to this Agreement.

CRESTRON LIMITED WARRANTY

CRESTRON warrants that: (a) the Software will perform substantially in accordance with the published specifications for a period of ninety (90) days from the date of receipt and (b) that any hardware accompanying the Software will be subject to its own limited warranty as stated in its accompanying written material. Crestron shall, at its option, repair or replace or refund the license fee for any Software found defective by Crestron if notified by you within the warranty period. The foregoing remedy shall be your exclusive remedy for any claim or loss arising from the Software.

CRESTRON shall not be liable to honor warranty terms if the product has been used in any application other than that for which it was intended or if it as been subjected to misuse, accidental damage, modification or improper installation procedures. Furthermore, this warranty does not cover any product that has had the serial number or license code altered, defaced, improperly obtained or removed.

Notwithstanding any agreement to maintain or correct errors or defects, Crestron shall have no obligation to service or correct any error or defect that is not reproducible by Crestron or is deemed in Crestron’s reasonable discretion to have resulted from (1) accident; unusual stress; neglect; misuse; failure of electric power, operation of the Software with other media not meeting or not maintained in accordance with the manufacturer’s specifications or causes other than ordinary use; (2) improper installation by anyone other than Crestron or its authorized agents of the Software that deviates from any operating procedures established by Crestron in the material and files provided to You by Crestron or its authorized agent; (3) use of the Software on unauthorized hardware or (4) modification of, alteration of or additions to the Software undertaken by persons other than Crestron or Crestron’s authorized agents.

ANY LIABILITY OF CRESTRON FOR A DEFECTIVE COPY OF THE SOFTWARE WILL BE LIMITED EXCLUSIVELY TO REPAIR OR REPLACEMENT OF YOUR COPY OF THE SOFTWARE WITH ANOTHER COPY OR REFUND OF THE INITIAL LICENSE FEE CRESTRON RECEIVED FROM YOU FOR THE DEFECTIVE COPY OF THE PRODUCT. THIS WARRANTY SHALL BE THE SOLE AND EXCLUSIVE REMEDY TO YOU. IN NO EVENT SHALL CRESTRON BE LIABLE FOR INCIDENTAL, CONSEQUENTIAL, SPECIAL OR PUNITIVE DAMAGES OF ANY KIND (PROPERTY OR ECONOMIC DAMAGES INCLUSIVE), EVEN IF A CRESTRON REPRESENTATIVE HAS BEEN ADVISED OF THE POSSIBILITY OF SUCH DAMAGES OR OF ANY CLAIM BY ANY THIRD PARTY. CRESTRON MAKES NO WARRANTIES, EXPRESS OR IMPLIED, AS TO TITLE OR INFRINGEMENT OF THIRD-PARTY RIGHTS, MERCHANTABILITY OR FITNESS FOR ANY PARTICULAR PURPOSE, OR ANY OTHER WARRANTIES, NOR AUTHORIZES ANY OTHER PARTY TO OFFER ANY WARRANTIES, INCLUDING WARRANTIES OF MERCHANTABILITY FOR THIS PRODUCT. THIS WARRANTY STATEMENT SUPERSEDES ALL PREVIOUS WARRANTIES.

Return and Warranty Policies

Merchandise Returns / Repair Service

1. No merchandise may be returned for credit, exchange or service without prior authorization from CRESTRON. To obtain warranty service for CRESTRON products, contact an authorized CRESTRON dealer. Only authorized CRESTRON dealers may contact the factory and request an RMA (Return Merchandise Authorization) number. Enclose a note specifying the nature of the problem, name and phone number of contact person, RMA number and return address.
2. Products may be returned for credit, exchange or service with a CRESTRON Return Merchandise Authorization (RMA) number. Authorized returns must be shipped freight prepaid to CRESTRON, 6 Volvo Drive, Rockleigh, N.J. or its authorized subsidiaries, with RMA number clearly marked on the outside of all cartons. Shipments arriving freight collect or without an RMA number shall be subject to refusal. CRESTRON reserves the right in its sole and absolute discretion to charge a 15% restocking fee plus shipping costs on any products returned with an RMA.
3. Return freight charges following repair of items under warranty shall be paid by CRESTRON, shipping by standard ground carrier. In the event repairs are found to be non-warranty, return freight costs shall be paid by the purchaser.

CRESTRON Limited Warranty

CRESTRON ELECTRONICS, Inc. warrants its products to be free from manufacturing defects in materials and workmanship under normal use for a period of three (3) years from the date of purchase from CRESTRON, with the following exceptions: disk drives and any other moving or rotating mechanical parts, pan/tilt heads and power supplies are covered for a period of one (1) year; touchscreen display and overlay components are covered for 90 days; batteries and incandescent lamps are not covered.

This warranty extends to products purchased directly from CRESTRON or an authorized CRESTRON dealer. Purchasers should inquire of the dealer regarding the nature and extent of the dealer's warranty, if any.

CRESTRON shall not be liable to honor the terms of this warranty if the product has been used in any application other than that for which it was intended or if it has been subjected to misuse, accidental damage, modification or improper installation procedures. Furthermore, this warranty does not cover any product that has had the serial number altered, defaced or removed.

This warranty shall be the sole and exclusive remedy to the original purchaser. In no event shall CRESTRON be liable for incidental or consequential damages of any kind (property or economic damages inclusive) arising from the sale or use of this equipment. CRESTRON is not liable for any claim made by a third party or made by the purchaser for a third party.

CRESTRON shall, at its option, repair or replace any product found defective, without charge for parts or labor. Repaired or replaced equipment and parts supplied under this warranty shall be covered only by the unexpired portion of the warranty.

Except as expressly set forth in this warranty, CRESTRON makes no other warranties, expressed or implied, nor authorizes any other party to offer any warranty, including any implied warranties of merchantability or fitness for a particular purpose. Any implied warranties that may be imposed by law are limited to the terms of this limited warranty. This warranty statement supersedes all previous warranties.

Trademark Information

All brand names, product names and trademarks are the sole property of their respective owners. Windows is a registered trademark of Microsoft Corporation. Windows95/98/Me/XP/Vista and WindowsNT/2000 are trademarks of Microsoft Corporation.

This page is intentionally left blank.



Crestron Electronics, Inc.
15 Volvo Drive Rockleigh, NJ 07647
Tel: 888.CRESTRON
Fax: 201.767.7576
www.crestron.com

Operations & Installation Guide – DOC. 6630A
(2019056)
03.08

Specifications subject to
change without notice.