

VECTOR CD1295 Series

Vector™ Performance Loudspeaker – Dual 12” Bi-Amplified 3-Way Coaxial 90° x 45°

- > A space-efficient, professional performance loudspeaker for large indoor spaces
- > Dual 12” (305 mm) LF transducers for increased output and improved pattern control
- > Advanced coaxial transducer with 90° x 45° HF horn
- > Available with HF horn rotated 90° for horizontal orientation (model VECTOR CD1295-RH)
- > Integrated HF compression driver with 3 inch (76 mm) titanium diaphragm
- > Delivers superior performance in combination with a Crestron Avia™ DSP
- > Precisely tuned for accurate, uncolored sound reproduction
- > Produces high intelligibility and natural sound quality for speech and program material
- > Achieves smooth bandwidth performance both within and beyond the specified coverage pattern
- > Uniform directionality affords consistent, targeted pattern control
- > Capable of high SPLs without coloration or distortion
- > Provides excellent cost-benefit compared to more conventional designs
- > 40° trapezoidal enclosure affords a clean, unimposing appearance
- > Rugged yet light construction for easy, reliable installation
- > Concealed M10 mounting points
- > Yoke bracket or forged shoulder eyebolts available separately
- > Neutrik® speakON® input and pass-through connections



Crestron® Vector™ Performance Loudspeakers provide a professional sound reinforcement speaker solution for large indoor spaces and venues. Featuring a revolutionary coaxial transducer design complemented by advanced Crestron Avia™ digital signal processing, Vector loudspeakers deliver exceptional intelligibility and natural sound quality for speech reinforcement, foreground music, and multimedia presentation applications. Compact, aesthetically-pleasing enclosures afford remarkable performance in less space. A choice of sizes and coverage patterns is offered to address the varying applications and room geometries found in auditoriums, theaters, lecture halls, houses of worship, convention centers, hotel ballrooms, sports facilities, night clubs, and public spaces.

The Vector CD1295 is a compact, trapezoidal speaker enclosure loaded with one 2-way coaxial transducer plus a second dedicated low-frequency transducer. The coaxial transducer is composed of a 12” (305 mm) LF driver and a 90° x 45° HF horn with 3” (76 mm) diaphragm compression driver. The second LF transducer is a 12” driver with enhanced low-frequency performance. Advanced engineering and construction of the complete speaker achieves a space-efficient design with high output capability and consistent pattern control.

Its integrated coaxial transducer aligns the low-frequency and high-frequency elements to produce precise transient response and uniform directionality across the entire frequency range. The two 12” LF drivers work together in a bi-amplified configuration to achieve an increase in overall output and improved low-frequency pattern control.

Note: Specify model VECTOR CD1295-RH for applications requiring the enclosure to be installed in a horizontal orientation. The VECTOR CD1295-RH is assembled with its high-frequency horn rotated 90°.

Advanced Coaxial Transducer

The LF/HF transducer in the Vector CD1295 represents a revolutionary advancement in coaxial speaker design. Its high-frequency horn features a large 3 inch (76 mm) titanium diaphragm compression driver, which operates at frequencies lower than typical, allowing the high-frequency horn to smooth the response of the low frequency section to reduce shadowing of the woofer by the horn. The woofer's large radiating surface works in conjunction with the high-frequency horn to improve directional control at the lower end of the horn's frequency range resulting in better pattern control throughout the critical voice band. The large diaphragm also allows the compression driver to produce higher sound pressure levels without distortion to deliver incredibly clear and dynamic sound quality for both speech and program material.

The complete coaxial transducer assembly employs a single neodymium magnet with dual-gap geometry, which minimizes the spacing between the compression driver and woofer voice coils. This integrated approach virtually eliminates the delay between the two drivers, allowing a passive crossover to be used to seamlessly blend the horn and woofer into a single point source. The reduced demand on the internal crossover helps to maximize efficiency and damping, and the use of a single neodymium magnet reduces the speaker's weight, size, and cost.

VECTOR CD1295 Series

Vector™ Performance Loudspeaker – Dual 12” Bi-Amplified 3-Way Coaxial 90° x 45°



Dual Low-Frequency Drivers

The Vector CD1295 employs an innovative and unconventional bi-amplified 3-way configuration using dual 12” LF transducers. Relative to the coaxial transducer, the dedicated LF transducer features increased excursion capability below 100 Hz. The frequency range of both drivers overlaps at precise levels to achieve a flat summed response, producing a higher overall output level compared to a more traditional LF/MF/HF 3-way system. The use of dual LF transducers also provides the benefit of extending usable LF pattern control by over an octave, reducing acoustic reflections in the room for better clarity and “projection.”

Crestron Avia™ Digital Signal Processing

Every aspect of the Vector CD1295 is designed to take advantage of the signal refining abilities of a [Crestron Avia](#) DSP. Vector loudspeakers and Crestron Avia processing work synergistically to produce a superior speaker system tuned for accurate, uncolored reproduction of voice and program signals. Precision signal processing is employed to accomplish what can't be done physically, strategically eliminating harsh-sounding resonances caused by horn reflections while retaining every nuance of the original signal.

Further refinements are employed to maximize transient response and deliver smooth bandwidth performance both within and beyond the speaker's nominal coverage pattern. The result is an extremely natural sounding speaker system with superior pattern control, improved intelligibility, reduced listener fatigue, and higher gain before feedback. Two channels of processing are employed to deliver an optimized signal to each transducer.

Versatile Installation

The Vector CD1295 is particularly effective in systems where targeted pattern control is desirable, including front of house, delay fill, and foreground music applications. Its clean appearance and familiar format facilitate acceptance by architects and interior designers, and the 40° trapezoidal angle allows it to be mounted near walls or ceilings without

obstructing sight lines. Concealed M10 mounting points are included to accommodate either an optional [yoke bracket](#) or forged shoulder [eyebolts](#) (each sold separately).

Note: Specify model VECTOR CD1295-RH for applications requiring the enclosure to be installed in a horizontal orientation. The VECTOR CD1295-RH is assembled with its high-frequency horn rotated 90°.

SPECIFICATIONS

Performance

LF Transducer: 12 inch (305 mm) woofer with 3 inch (76 mm) voice coil and ceramic magnet

LF/HF Transducers: 12 inch (305 mm) woofer with 3 inch (76 mm) voice coil, coaxial horn with 3 inch (76 mm) titanium diaphragm compression driver, single neodymium magnet

Beamwidth: 90° x 45° nominal, available with horn rotated 90° for horizontal orientation (model VECTOR CD1295-RH)

Impedance: 8 Ohms nominal (per section)

Frequency Range: 49 Hz to 19 kHz (+3/-10 dB)

Power Handling: LF: 350 Watts;

LF/HF: 400 Watts;

Based on the AES power handling of the transducers

Nominal Sensitivity:

LF: 98 dB;

LF/HF: 104 dB;

Measured at 1W/1m whole space using band limited pink noise without processing

Nominal Maximum SPL:

LF: 129 dB peak, 123 dB continuous, at 350W/1m;

LF/HF: 136 dB peak, 130 dB continuous, at 400W/1m;

Without processing

Equalized Sensitivity: 98 dB at 1W/1m using an EIA-426-B signal with processing

Equalized Maximum SPL:

LF: 133 dB peak, 127 dB continuous, at 350W/1m;

LF: 133 dB peak, 127 dB continuous, at 400W/1m;

With processing

Processing & Amplification

Digital Signal Processing: Requires processing using two output channels of a [Crestron Avia DSP](#), settings provided via model-specific “Speaker Profiles” in the Crestron Avia Audio Tool software ([SW-AAT](#))

Amplification: Bi-amplified, requires two channels of amplification

Recommended Amplifier Power: LF: 350 to 700 Watts at 8 Ohms;

LF/HF: 400 to 800 Watts at 8 Ohms

Connections

Input: (2) Neutrik NL4 speakON 4-pole chassis connectors;

Pins 1 +/-: LF speaker input and pass-through;

Pins 2 +/-: LF/HF speaker input and pass-through

VECTOR CD1295 Series

Vector™ Performance Loudspeaker – Dual 12” Bi-Amplified 3-Way Coaxial 90° x 45°

Environmental

For indoor use only

Construction

Enclosure: Void-free, exterior grade Baltic Birch plywood; black painted finish

Grille: Steel, black powder coat finish

Yoke Mounting: (2) M10 yoke points ([yoke bracket](#) sold separately)

Suspension: (12) M10 eyebolt angle points and (1) M10 pull back point ([eyebolts](#) sold separately)

Dimensions

Height: 28.00 in (711 mm)

Width: 17.99 in (457 mm)

Depth: 15.99 in (406 mm)

Weight

63.0 lb (28.6 kg)

MODELS & ACCESSORIES

Available Models

VECTOR CD1295: Vector™ Performance Loudspeaker – Dual 12” Bi-Amplified 3-Way Coaxial 90° x 45°

VECTOR CD1295-RH: Vector™ Performance Loudspeaker – Dual 12” Bi-Amplified 3-Way Coaxial 90° x 45°, Rotated Horn

Available Accessories

VECTOR YOKE12D: Yoke Bracket for VECTOR CD1265 & CD1295 Series

VECTOR EB10: M10 Forged Shoulder Eyebolt

VECTOR CONN4: Neutrik® NL4 speakON® 4-Pole Cable Connector

DSP Series: Crestron Avia™ Digital Signal Processors

AMP-2800: 2-Channel Power Amplifier, 800W/Ch.

AMP-4600: 4-Channel Power Amplifier, 600W/Ch.

VECTOR SUBS15: Vector™ 15” Performance Subwoofer

VECTOR SUBS18: Vector™ 18” Performance Subwoofer

VECTOR SUBD18: Vector™ Dual 18” Performance Subwoofer

Notes:

This product may be purchased from an authorized Crestron dealer. To find a dealer, please contact the Crestron sales representative for your area. A list of sales representatives is available online at <https://www.crestron.com/How-To-Buy/Find-a-Representative> or by calling 855-263-8754.

The specific patents that cover this and other Crestron products are listed online at <https://www.crestron.com/legal/patents>.

Certain Crestron products contain open source software. For specific information, visit <https://www.crestron.com/opensource>.

Crestron, the Crestron logo, Crestron Avia, and Vector are either trademarks or registered trademarks of Crestron Electronics, Inc. in the United States and/or other countries. Dante is either a trademark or registered trademark of Audinate Pty Ltd. in the United States and/or other countries. Neutrik and speakON are either trademarks or registered trademarks of Neutrik AG in the United States and/or other countries. Other trademarks, registered trademarks, and trade names may be used in this document to refer to either the entities claiming the marks and names or their products. Crestron disclaims any proprietary interest in the marks and names of others. Crestron is not responsible for errors in typography or photography. Specifications are subject to change without notice. ©2018 Crestron Electronics, Inc.

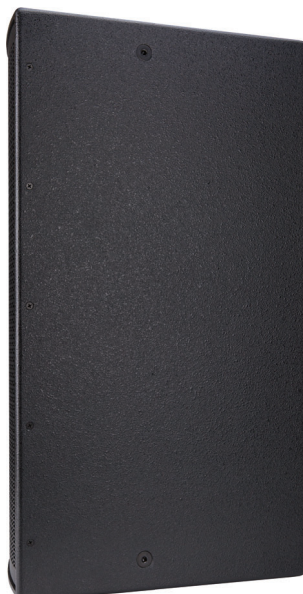

VECTOR CD1295 Series Vector™ Performance Loudspeaker – Dual 12" Bi-Amplified 3-Way Coaxial 90° x 45°

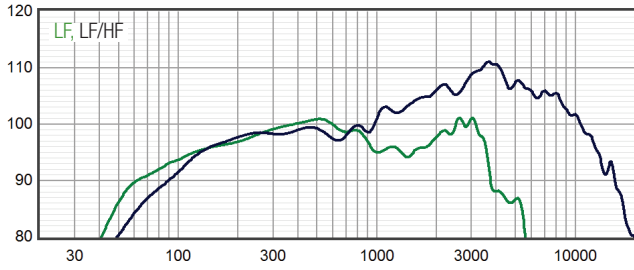

Axial Sensitivity (dB SPL, 1W/1m)

Plotted against frequency for a 1 watt swept sine wave, referenced to 1 m without processing

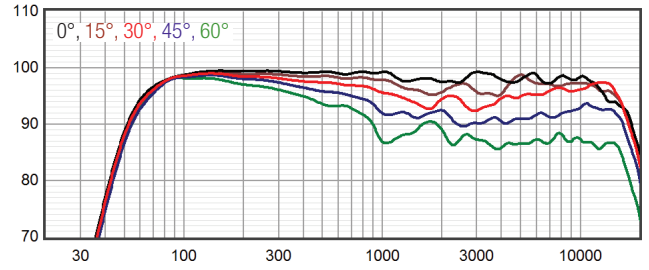

Horizontal Off Axis Response

The magnitude response at various angles off axis, with processing

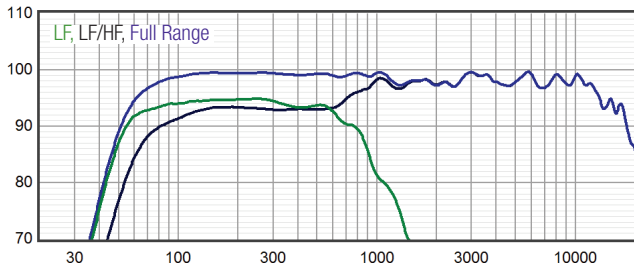

Axial Processed Response (dB)

The axial magnitude response with processing

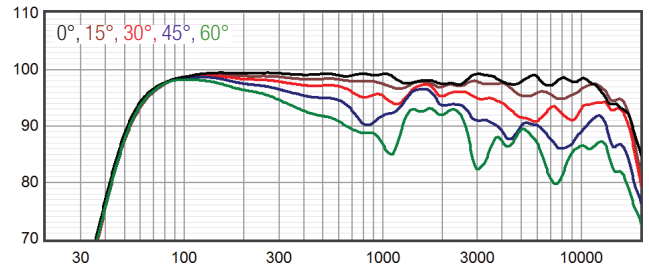

Vertical Off Axis Response

The magnitude response at various angles off axis, with processing

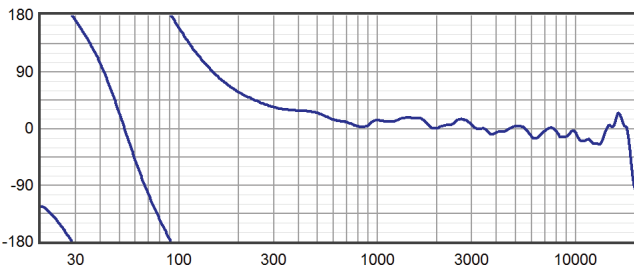

Axial Processed Phase Response (degrees)

The axial phase response with processing

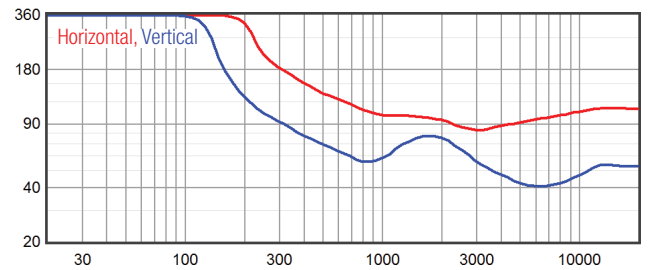

Beamwidth

The angle between the -6 dB points in the speaker's polar response

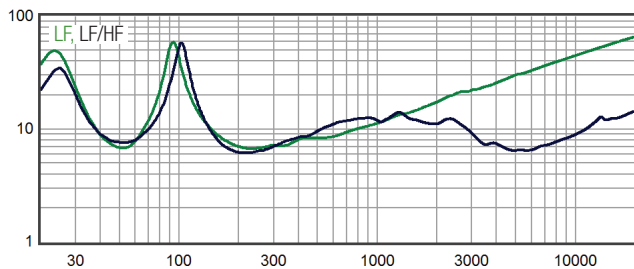

Impedance (Ohms)

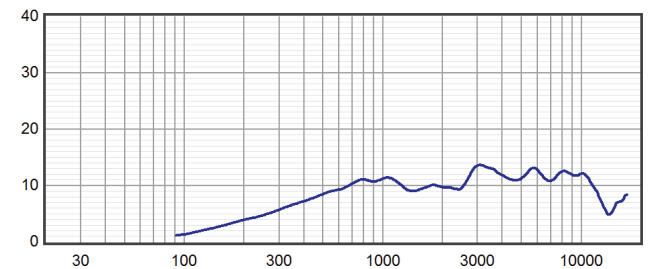

Directivity Index (dB)

The ratio of the on-axis sound pressure squared to the spherical average of the sound pressure squared at a particular frequency expressed in dB. To convert the directivity index (Di) to directivity factor (Q) use the formula: $10 \text{ Di}/10$

VECTOR CD1295 Series Vector™ Performance Loudspeaker – Dual 12" Bi-Amplified 3-Way Coaxial 90° x 45°

100 Hz
125 Hz
160 Hz
200 Hz

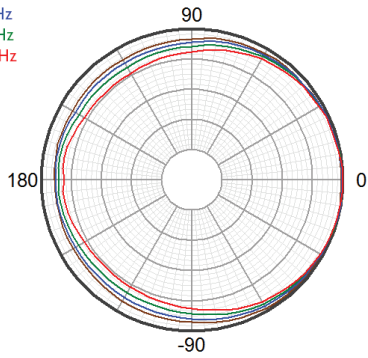

250 Hz
315 Hz
400 Hz
500 Hz

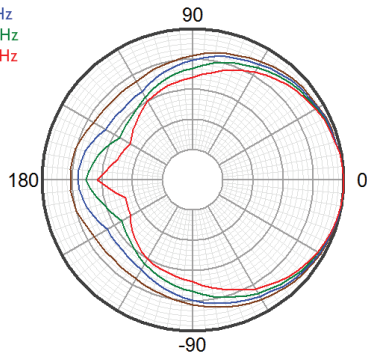

630 Hz
800 Hz
1000 Hz
1250 Hz

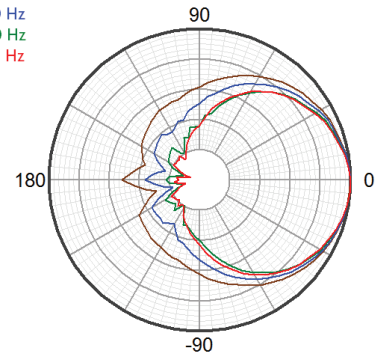

1600 Hz
2000 Hz
2500 Hz
3150 Hz

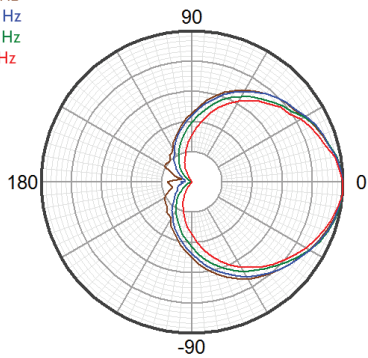

4000 Hz
5000 Hz
6300 Hz
8000 Hz

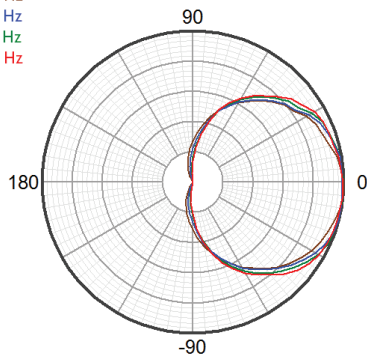

10000 Hz
12500 Hz
16000 Hz

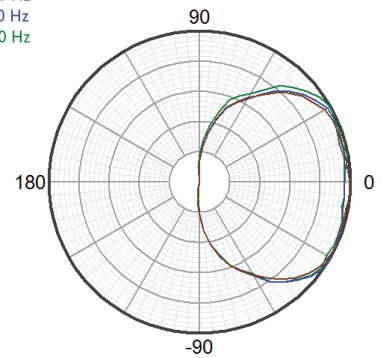

Horizontal Polar Response (30 dB Scale, 6 dB per Major Division)

100 Hz
125 Hz
160 Hz
200 Hz

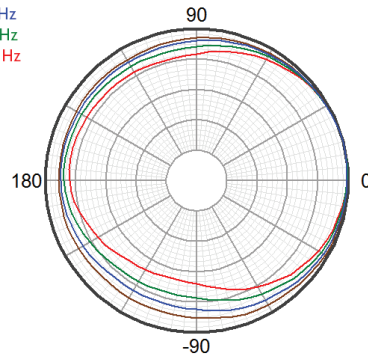

250 Hz
315 Hz
400 Hz
500 Hz

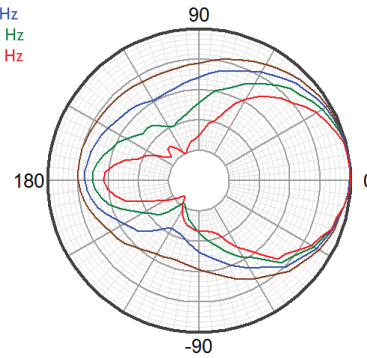

630 Hz
800 Hz
1000 Hz
1250 Hz

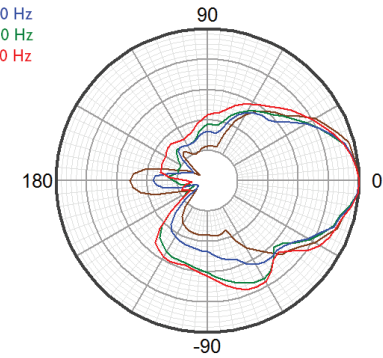

1600 Hz
2000 Hz
2500 Hz
3150 Hz

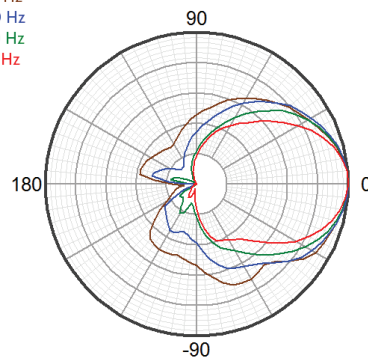

4000 Hz
5000 Hz
6300 Hz
8000 Hz

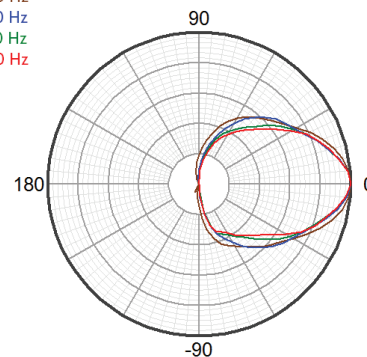

10000 Hz
12500 Hz
16000 Hz

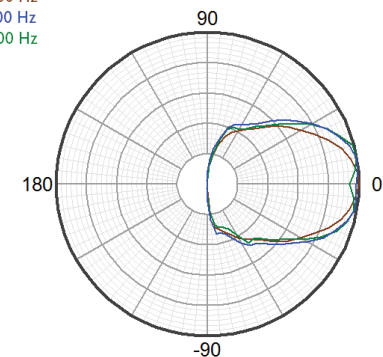

Vertical Polar Response (30 dB Scale, 6 dB per Major Division)

VECTOR CD1295 Series

Vector™ Performance Loudspeaker – Dual 12" Bi-Amplified 3-Way Coaxial 90° x 45°

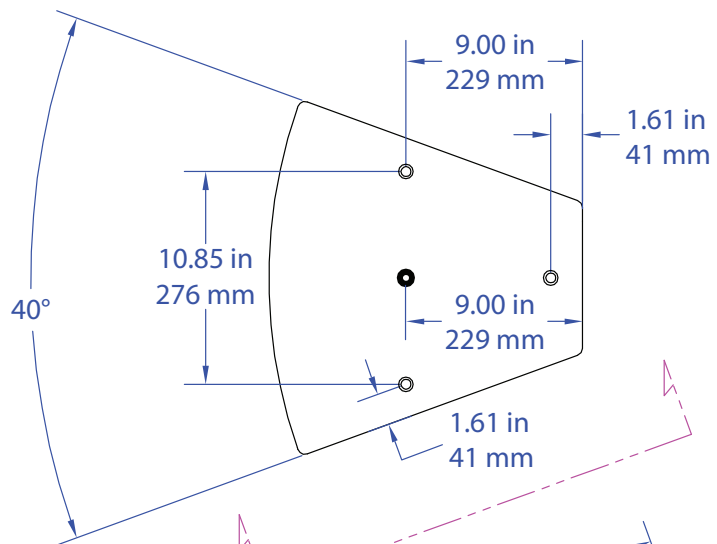
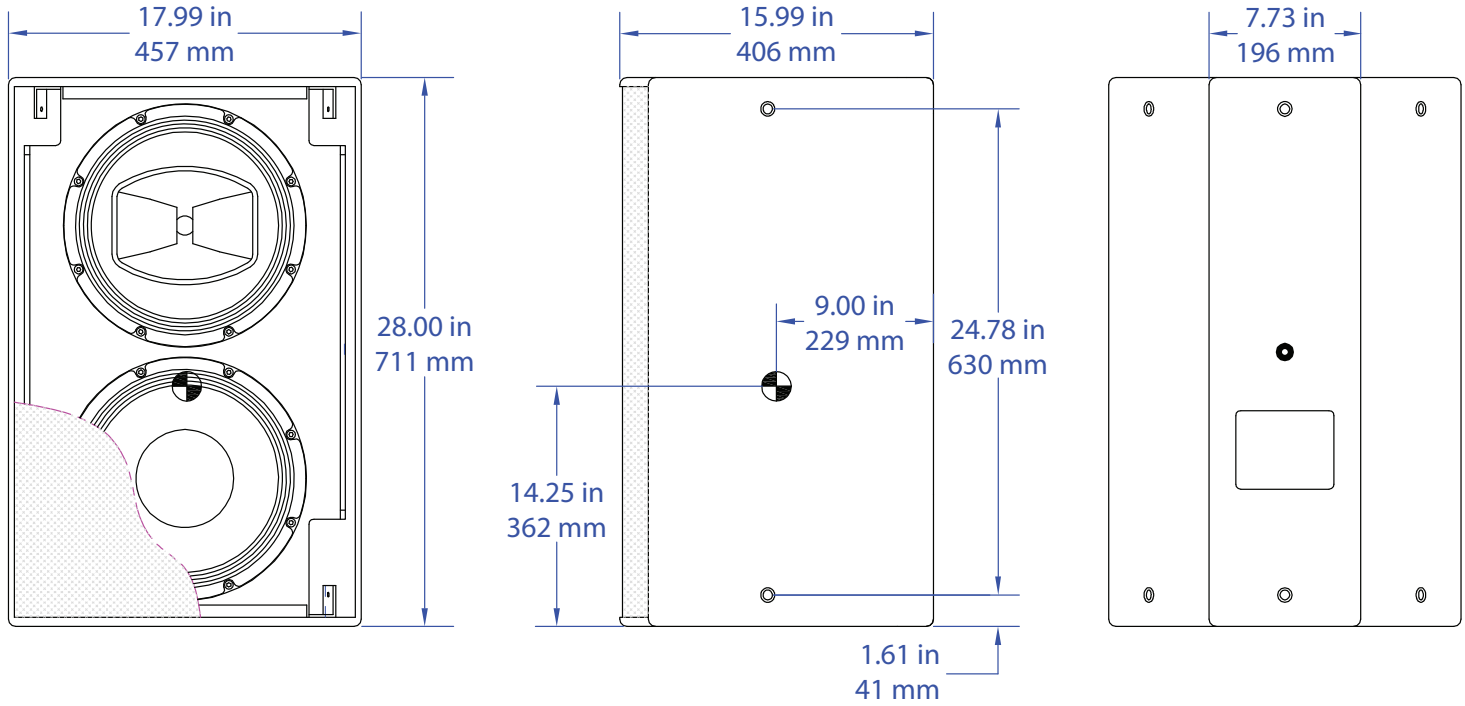

Symbol Key:

- ⊙ = M10 Eyebolt angle point
- = M10 Nut plate
- ⊙/● = CoG

