

Crestron **CNWM & CNWML** Hand-Held Wireless Mouse

Operations Guide



Contents

Wireless Mouse	1
Description	1
Functional Description	1
Physical Description	2
Leading Specifications	3
Setup	4
General Use and Safety	4
RF Identity Code	4
Programming (Cresnet and SmarTouch systems)	9
Programming in SIMPL Windows (Cresnet and SmarTouch systems)	11
Accessing the Inlay Card	18
Problem Solving	20
Troubleshooting	20
Further Inquiries	21
Return and Warranty Policies	22
Merchandise Returns / Repair Service	22
CRESTRON Limited Warranty	22
Appendix A: AT Scan Code	23

Wireless Mouse

Description

Functional Description

The wireless mouse is a hand-held user interface that uses radio frequency (RF) to communicate with the CRESNET system, SmartTouch STS or the portable SmartPresenter system. As part of the CRESNET system, the wireless mouse communicates with the system via the CNRFGWA, RF receiver. As part of the SmartTouch STS, the wireless mouse communicates with the system via the ST-CP, control processor. When used with the SmartPresenter system, the wireless mouse communicates with the system control processor, SP-1.

NOTE: The CNRFGWA must have PROM # 2251 for wireless mouse support. A CNRFGWA with this PROM reports on the network with software version 2.00. Early versions of the CNRFGWA do not support the wireless mouse.

Models

There are two CRESTRON wireless mice available: CNWM and CNWML. The only difference between the two configurations is that one, the CNWML, is equipped with a laser pointer. The laser can be turned ON and OFF by depressing the center button (button 5) or button 4 on the keypad of the unit.

CNWM/L used with Cresnet

By design, the most logical application for the wireless mouse is as the user interface in a presentation system. The wireless mouse and PC keyboard/mouse controller, CNMK, can be added to control your PC presentation. These devices in conjunction with CRESTRON's simple-to-use Windows software improve the portability of the user interface. They facilitate the transmission of programmed PC mouse and keyboard operations as well as serial and IR device commands remotely.

CNWM/L used with SmartTouch™

The CNWM/L can be used in a SmartTouch system. SmartTouch is a radio frequency (RF) control system that offers unprecedented performance and value. Adding the CNWML to the SmartTouch system offers keyboard and mouse emulation (with optional CNMK) and multi-purpose AV control.

CNWM/L used with SmartPresenter™

The wireless mouse serves as the RF transmitter for the SmartPresenter™ system. This is a unique presentation system that is fully operational using the wireless mouse. With only the compact SP-1 control processor and the wireless mouse, users can control up to four IR devices and one RS-232 device. SmartPresenter has the potential to control up to six functions per device. Functions are assigned to the four positions of the mouse button, the mouse trigger, and the center keypad button on the wireless mouse. The SmartPresenter system can be programmed easily in the field using the CNWM/L. Refer to the SmartPresenter Quick Guide (DOC. 5742) for additional information on field programming.

Physical Description

The wireless mouse, shown below, is housed in a black plastic enclosure that can easily fit in the user's palm. Nearly all the buttons, except for the trigger, can be found on the topside of the unit. The trigger can be found on the bottom of the unit. Button placement has been carefully designed into the unit for ease of use.

Wireless Mouse Physical Views

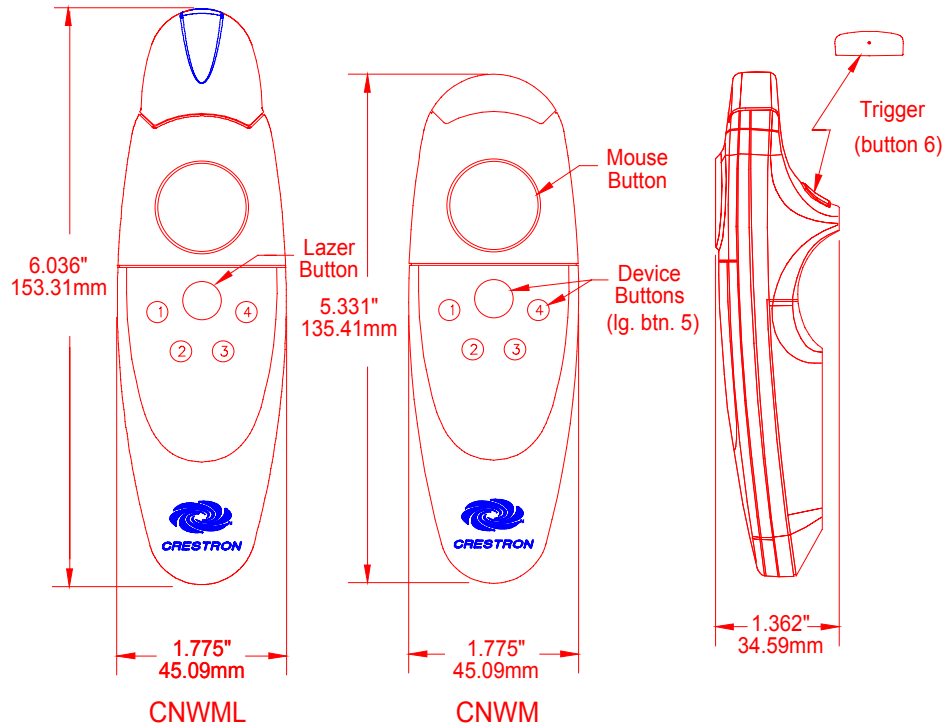

Notice the lined paper beneath the clear plastic cover that surrounds the keypad buttons. Once functionality has been assigned to the keypad buttons, a brief description can be written on the lined paper. For a more professional look, a label kit (SP-LK) is available for the wireless mice. The SP-LK label kit provides a sheet of the most common control functions and several pre-cut mouse inlay cards.

To access the inlay card, refer to "Accessing the Inlay Card" on page 18.

Two AAA-sized batteries are provided with the wireless mouse. Access to the battery compartment is permitted after the battery cover is removed. A sensor (photo transistor) used to program the RF identity code is also located in the battery compartment.

Battery Compartment (Rear View)

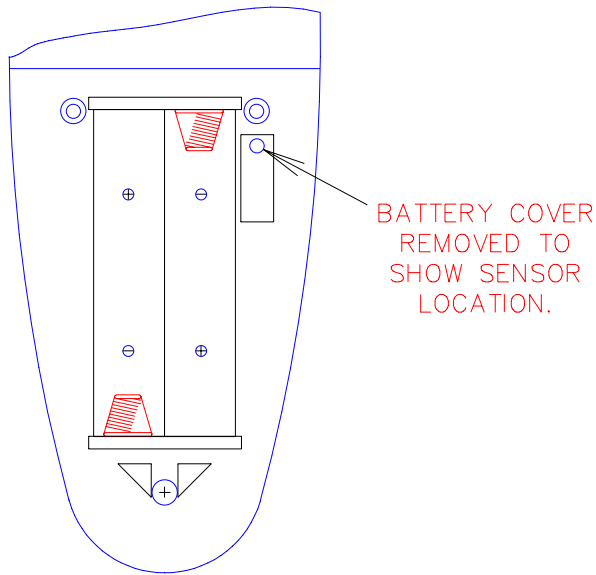

Leading Specifications

The table below provides a summary of leading specifications for the wireless mouse. Dimensions and weight are approximations rounded to the nearest thousandth unit.

Leading Specifications of the Wireless Mouse

SPECIFICATION	DETAILS
Battery	2 disposable "AAA" cells
SIMPL™ Windows®	Version 1.18 or later
CRESNET Operating System	3.17.29 or later
CNRFGWA Software	version 2.00/PROM # 2251
SmarTouch (ST-CP) Operating System*	4.00.38-s or later
SmarTouch (ST-CP) Monitor Version*	1.29 or later
VisionTools Pro™	Version 1.1.3 or later
Dimensions & Weight (without batteries)	Height: 5.331 in (13.541 cm) for CN-WM 6.036 in (15.33 cm) for CN-WML Width: 1.775 in (4.509 cm) Depth: 1.380 in (3.505 cm) Weight: 0.140 lb (0.064 kg) for CN-WM 0.270 lb (0.122 kg) for CN-WML

* **NOTE:** Upload the SmarTouch Monitor before uploading the SmarTouch Operating System.

Laser Specifications of the CNWML

SPECIFICATION	DETAILS
Wavelength	670 nm (Class IIIa Product)
Output Power	Less than 5 mW

NOTE: This equipment has been tested and found to comply with the limits for a Class B digital device, pursuant to part 15 of the FCC Rules. These limits are designed to provide reasonable protection against harmful interference in a residential installation. The equipment generates, uses and can radiate radio frequency energy and, if not installed and used in accordance with the instructions, may cause harmful interference to radio communications. However, there is no guarantee that interference will not occur in a particular installation. If this equipment does cause harmful interference to radio or television reception, which can be determined by turning the equipment off and on, the user is encouraged to try to correct the interference by one or more of the following measures:

- Reorient or relocate the receiving antenna.
 - Increase the separation between the equipment and receiver.
 - Connect the equipment into an outlet on a circuit different from that to which the receiver is connected.
 - Consult the dealer or an experienced radio/TV technician for help.
-

As of the date of manufacture, the unit has been tested and found to comply with specifications for CE marking.



Setup

General Use and Safety

DANGER: The CNWML contains a Class IIIa laser. Avoid direct eye exposure.

Compliance to the following suggestions may extend the life of the wireless mouse and laser.

- If the unit is not going to be used for a month or longer, remove batteries. Never leave weak or dead batteries in the unit; they might leak chemicals that can damage the unit.
- Use care when handling the unit. Dropping the unit can unfocus the lens, damage circuit boards, and cause the unit to work improperly.
- Operate and store the unit in moderate temperatures. Do not place the unit in environments below freezing or exceeding 110°F. Temperature extremes can shorten the life of electrical devices, damage the batteries, and distort or melt plastic parts.
- Keep the unit away from dust and dirt that can cause premature wear on parts. Use a damp cloth to wipe the unit. Do not use harsh chemicals, cleaning solvents, or strong detergents to clean the device.

RF Identity Code

Every hand-held wireless transmitter communicating with either the SmartPresenter, ST-CP or CNRFGWA requires a unique RF identity (ID) code. The code is a two-

digit hexadecimal number. To maintain code diversity within a system, use codes between 10 and FE for the transmitters. There are two methods to change the RF ID code on the wireless mouse: via the CNIDC (Identity Code Cable) and Viewport software or depressing buttons on the unit that represent a binary code.

NOTES: The RF ID CODE on the wireless mouse is factory set to 30.

Only use 10 through FE as RF ID code.

Do not confuse RF ID with network (NET) ID.

**Match CNWM/L ID to SP-1 Receiver
(SmartPresenter)**

Depress and hold the recessed button #1 on the SP-1 for at least 5 seconds (use a paper clip or similar object) or until the red RF LED flashes on the SP-1.

Depress (position A) button on the CNWM/L while the RF LED flashes. Observe that RF LED stops flashing and remains illuminated for about 4 seconds.

NOTE: An extinguished LED indicates a match of CNWM/L ID to that of the SP-1.

If the RF ID does not match, refer to "Change RF ID via CNWM/L Button Presses" on page 7.

**Verify RF ID with Crestron Software
(not required for SmartPresenter)**

Use the Crestron Performance ViewPort to view transmitter ID codes. Using either SIMPL Windows or VisionTools Pro, select **ViewPort** from the **Tools** menu; the "Crestron Performance Viewport" dialog box, shown below, appears.

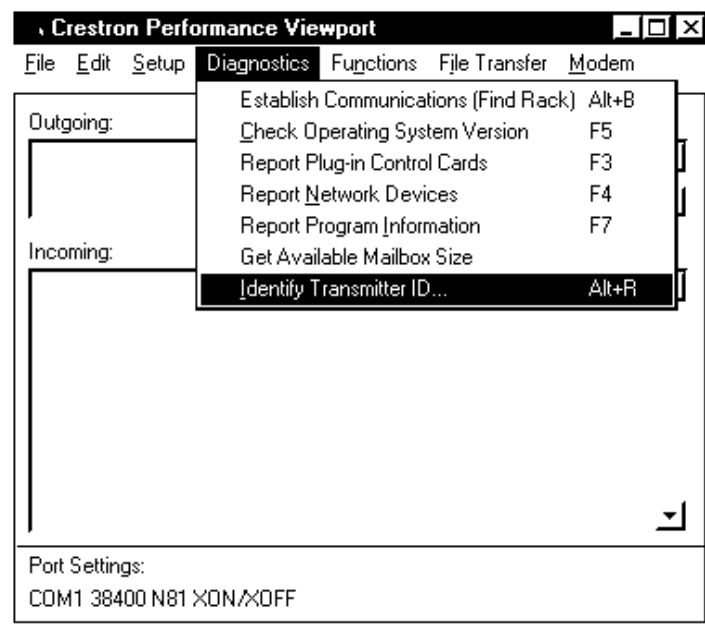

From the **Diagnostics** menu in the dialog box, select **Identify Transmitter ID** to open the "Transmitter Identification" dialog box. Press a button on the transmitter, ViewPort will display the transmitter ID in hexadecimal format.

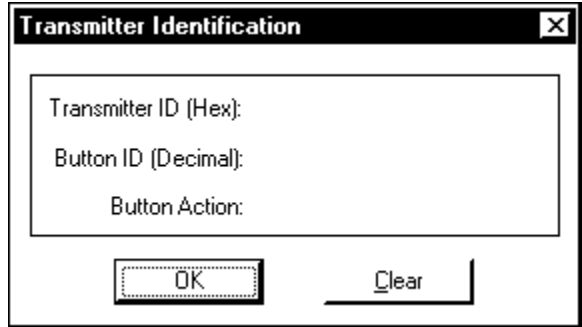

**Change RF ID Crestron Software
(not required for SmartPresenter)**

Use the Crestron Performance ViewPort to set a RF ID CODE. Using either SIMPL Windows or VisionTools Pro, select **ViewPort** from the **Tools** menu; the “Crestron Performance Viewport” dialog box, shown below, appears.

Crestron Performance Viewport Dialog Box

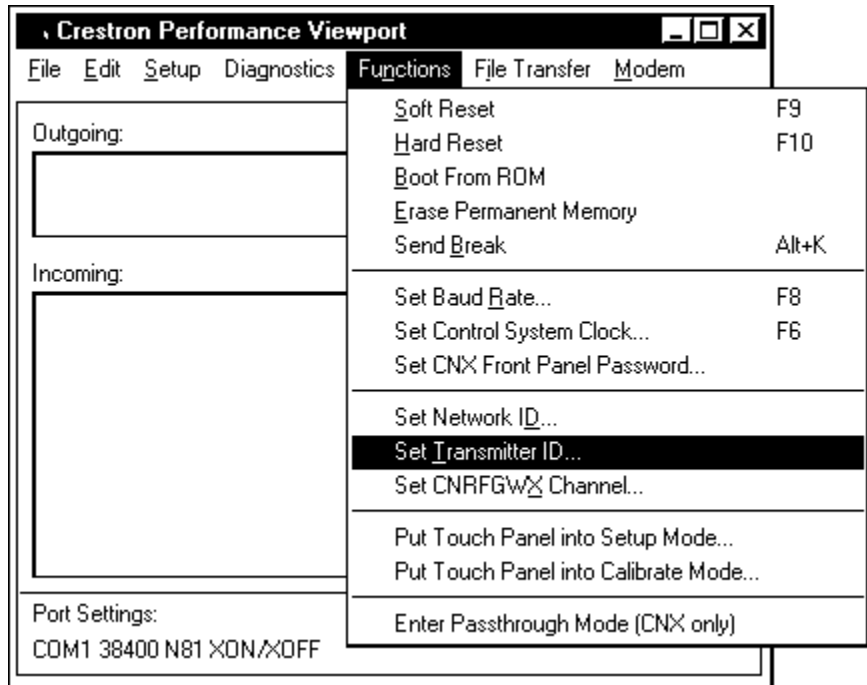

From the **Options** menu in the dialog box, select **Set Transmitter ID** to open the “Set Transmitter ID” dialog box. Enter a two-digit hexadecimal number ranging from 10 to FE. Click **OK** to confirm.

Set Transmitter ID Dialog Box

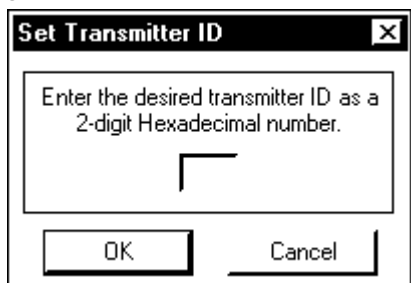

The "Transmitter ID" dialog box is displayed. It prompts the user to properly position the CNIDC (IR probe). Connect the 9-pin DIN connector from the CNIDC to the proper COM port on the back of the PC.

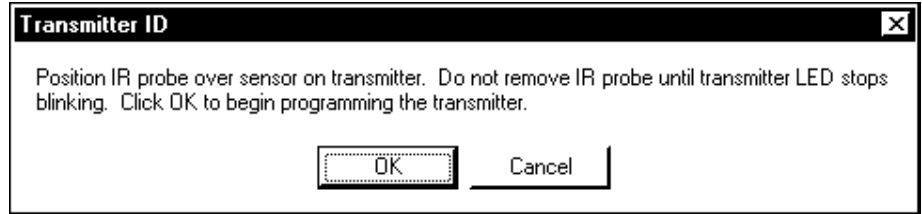

Position the wireless mouse button-side down so the battery compartment is accessible. Remove the battery compartment cover to expose the battery compartment.

Place the LED probe from the CNIDC over the sensor (photo transistor), as shown below. The probe should rest between the battery compartment and the sensor opening so that it completely covers the opening.

Probe Placement

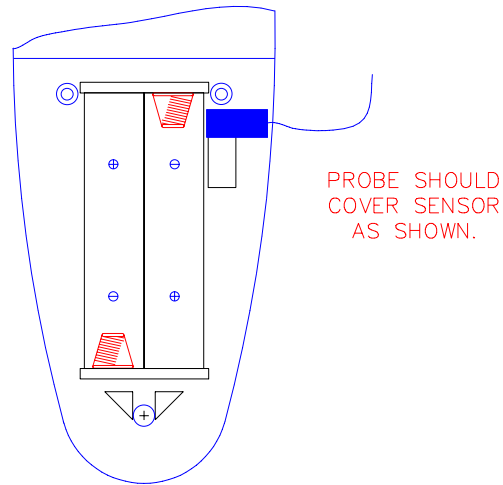

In the "Transmitter ID" dialog box, click **OK** to program the transmitter.

When the LED stops blinking, secure the battery cover over the battery compartment. Disconnect the CNIDC from the PC.

Change RF ID via CNWM/L Button Presses

A procedure to change the RF ID using button presses has an advantage over the CNIDC/Software method, because no extraneous items (i.e., software and probe) are required. All that is needed is the unit itself and knowledge of representing an alphanumeric hex digit as a four-digit binary code. Select buttons 2 and 4 on the wireless mouse correspond to the binary digits 0 and 1, respectively. If your recall of binary coding is rusty, refer to the table that follows the procedure. It provides the four-digit binary code and sequential four button press/release on the unit for each single alphanumeric digit. For example, if the RF ID needs to be changed to 40, a hexadecimal "4" is represented as 0100 in binary code or by pressing and releasing the select buttons in the following sequence 2422. Likewise, hexadecimal "0" is represented as 0000 in binary or a sequential button press/release of 2222. Complete the following procedure to set a RF ID of 25. (Steps 1 through 3 must precede any eight button sequence to initialize the unit.)

1. Open battery compartment and remove one battery.

2. Press and hold button 1 on the unit while replacing battery.
3. Replace battery compartment cover and release button 1.
4. Press/release button 2 (binary 0).
5. Press/release button 2.
6. Press/release button 4 (binary 1).
7. Press/release button 2.
8. Press/release button 2.
9. Press/release button 4.
10. Press/release button 2.
11. Press/release button 4.

RF ID CODE Conversion Table

HEX (ALPHANUMERIC DIGIT)	BINARY CODE	BUTTON PRESS/RELEASE
0	0000	2222
1	0001	2224
2	0010	2242
3	0011	2244
4	0100	2422
5	0101	2424
6	0110	2442
7	0111	2444
8	1000	4222
9	1001	4224
A	1010	4242
B	1011	4244
C	1100	4422
D	1101	4424
E	1110	4442
F	1111	4444

Laser Button Selection via CNWML Button Presses

The following procedures describe how either the center keypad button or button 4 can be assigned to the laser pointer and how to disable the laser pointer.

NOTE: A button that is assigned the laser pointing function does not transmit a code.

Center Keypad Button

1. Open battery compartment and remove one battery.
2. Press and hold the large center keypad button on the unit while replacing battery.
3. Release center keypad button and replace battery compartment cover. The center keypad button is assigned to the laser pointer.

Keypad Button 4

1. Open battery compartment and remove one battery.
2. Press and hold keypad button 4 on the unit while replacing battery.

3. Release keypad button 4 and replace battery compartment cover. The keypad button 4 is assigned to the laser pointer.

Disable Laser Pointer

1. Open battery compartment and remove one battery.
2. Press and hold keypad button 3 on the unit while replacing battery.
3. Release keypad button 3 and replace battery compartment cover. The laser pointer is disabled.

NOTE: If no buttons are pressed while replacing the batteries, then the previous ID and laser pointer button assignment is restored.

Programming (Cresnet and SmarTouch systems)

The wireless mouse is unlike any other user interface available from CRESTRON. It permits the user full mobility about a given area while providing remote control of the system PC (via mouse and keyboard operation) and other controllable devices such as a TV and VCR. The wireless mouse has clearly been designed, although not limited, to simplify the task of orchestrating a presentation. Due to its uniqueness, CRESTRON provides a sample project (wireless mouse sample project.vtp) for the wireless mouse with VisionTools Pro software.

Note: the sample project "sample mouse project.vtp" is available in VisionTools Pro v1.1.4 or later.

CRESTRON recommends that the user does not create a wireless mouse project from scratch, but rather copy the sample available from VT Pro software and use it as a platform on which the user builds their own custom programming. Select **Open | Project** from the **File** menu. Choose "wireless mouse sample project.vtp" and click **Open**.

Open "wireless mouse sample project.vtp"

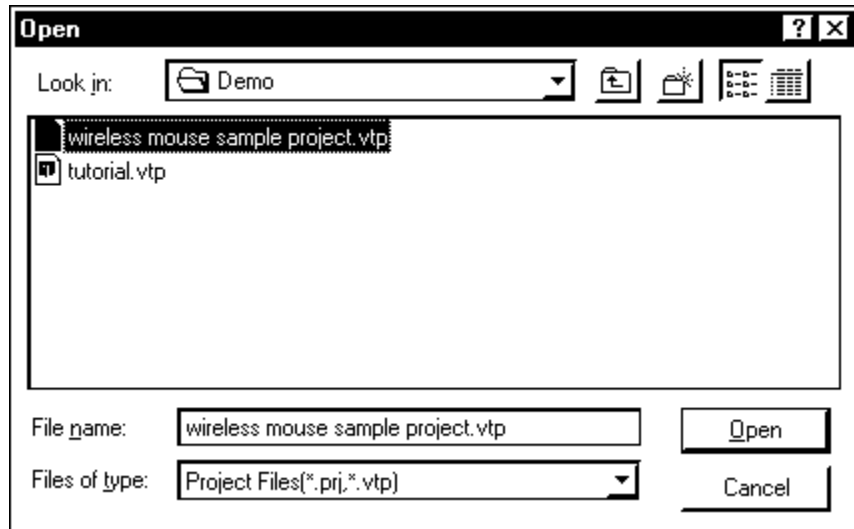

Once the sample project is open, select **Save Project As** from the **File** menu. This will make a copy of the file that can be used as the foundation of a new project. In the "Save Project As..." dialog box, enter a file name and click **Save**.

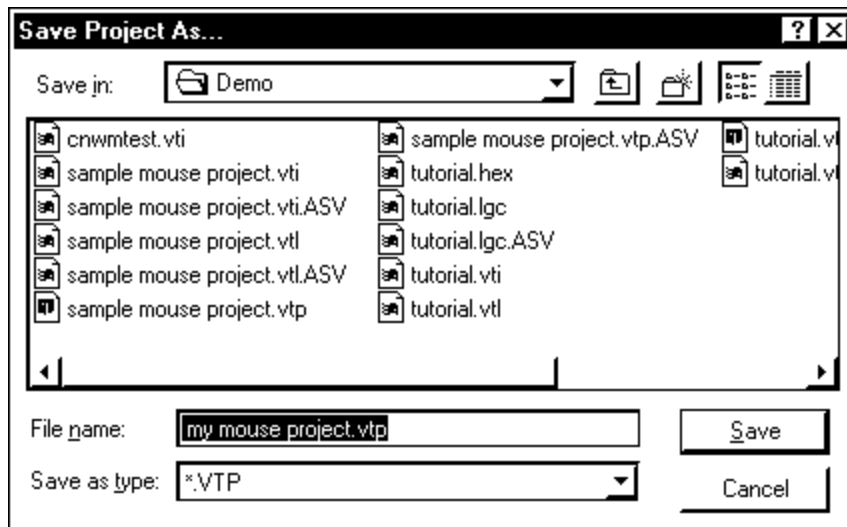

The CNWM sample project has one page, shown below, and is designed to control predetermined PC mouse and keyboard operations and certain VCR and TV transport functions. If the particular devices in the custom system do not match those in the sample, alterations are necessary. Changes can be easily made by simply opening up certain dialog boxes and modifying some of the fields. For example, to access the functional properties of the button, simply right-click on the object and select Function from the pop-up menu. The "Function" dialog box appears. The more the system devices differ from the sample project, the more extensive changes become.

NOTE: The CNWM is not limited to the functions and device control portrayed in the sample project. The unit can be programmed as a wireless transmitter capable of controlling multiple serial and IR devices remotely.

Open Page of "wireless mouse sample project.vtp"

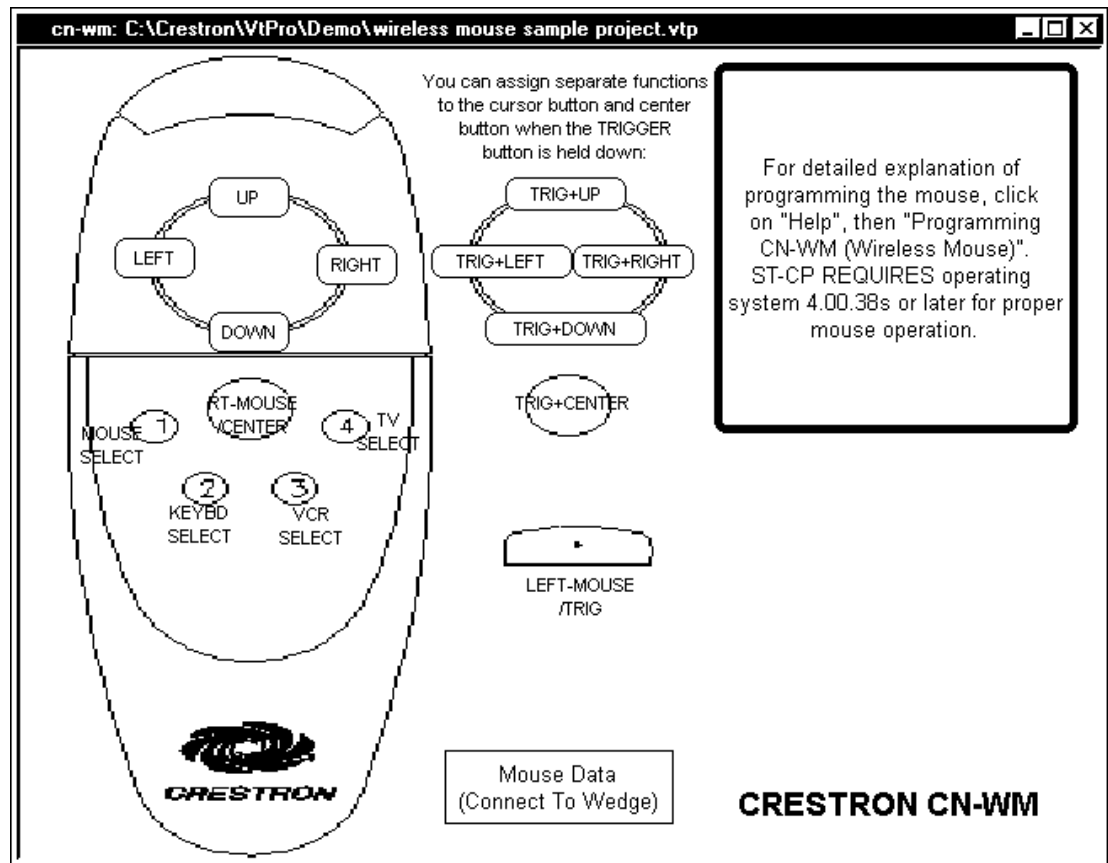

If you draw your own project, remember to change the target type to CNWM in the dialog box after selecting New and Project from the File menu.

Programming in SIMPL Windows (Cresnet and SmarTouch systems)

SIMPL (Symbol Intensive Master Programming Language) is an easy-to-use programming language that is completely integrated and compatible with all Crestron system hardware. The objects that are used in SIMPL are called symbols.

SIMPL Windows is Crestron Electronics' software for programming Crestron control systems. It provides a well-designed graphical environment with a number of workspaces (i.e., windows) in which a programmer can select, configure, program, test, and monitor a Crestron control system. SIMPL Windows offers drag and drop functionality in a familiar Windows® environment.

The next two subsections describe a sample SIMPL Windows program that utilizes a CNWM mouse. The first subsection details how the sample program works with a textual description and block diagram. The second subsection provides a broad description of how to actually create the SIMPL Windows program.

NOTE: The following description assumes that the reader has knowledge of SIMPL Windows. If not, please refer to the extensive help information provided with the software.

NOTE: The following SIMPL Windows sample programs are available on Crestron's ControlCD (v5.1 and later) or the Crestron website **crestron.com**. Search the SIMPL Windows Example Base for cnwm-ctl.smw and cnwm-prs.smw

How the Program Works

Two basic CNWM SIMPL Windows programs are shown in block diagram form. These two basic SIMPL programs (presentation system and wireless transmitter) are shown and described below.

Example 1 - Presentation System

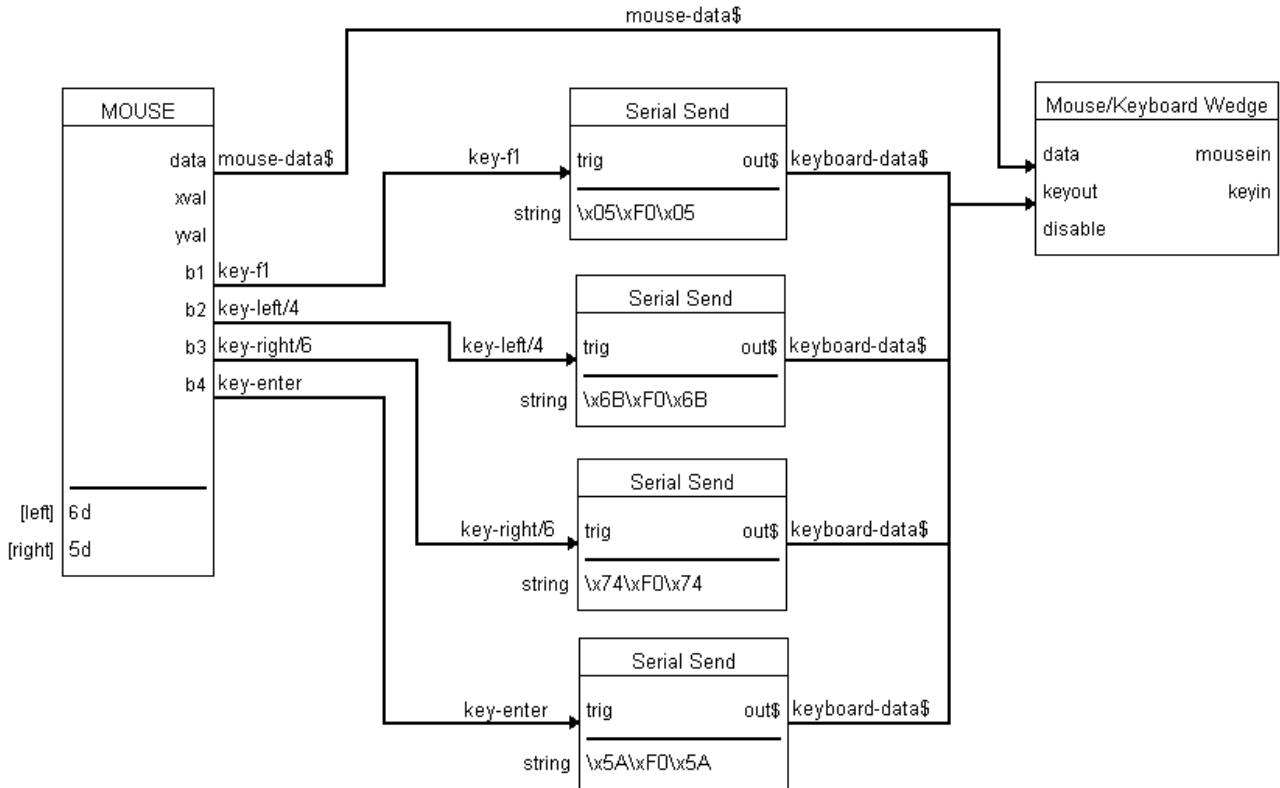

This presentation system sample is designed to control predetermined PC mouse and keyboard operations. For this purpose, a CNMK, mouse/keyboard controller (also known as a "Wedge") is required in the system. The large mouse button on the wireless mouse is used to move the cursor. The larger keypad button is used as a right mouse click and the trigger is used as a left mouse click. The four small keypad buttons perform keyboard functions.

Example 2 - Wireless Transmitter

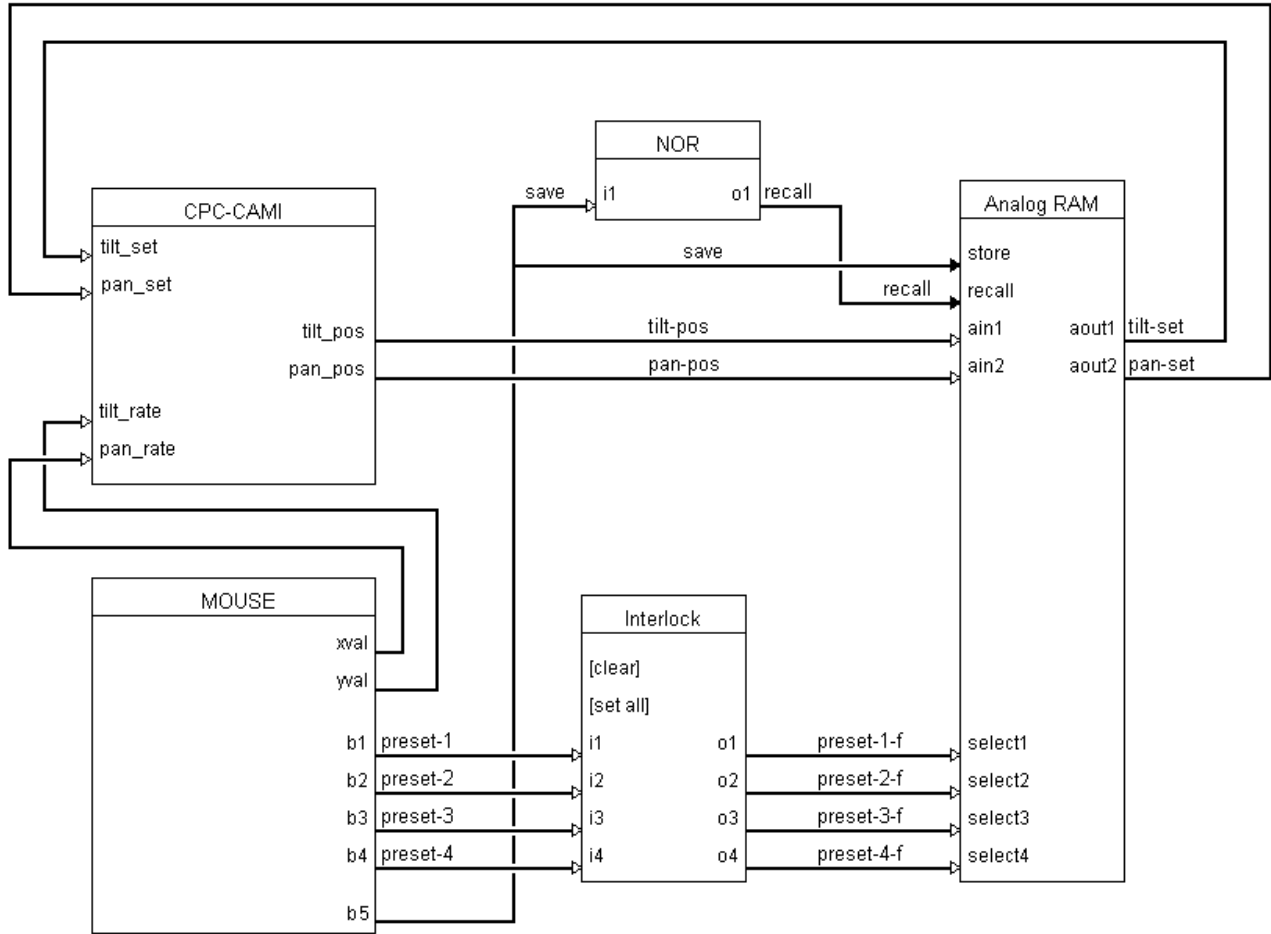

This example shows a CNWM controlling a CRESTRON CPC-CAMI. The large mouse button on the wireless mouse is used to control pan by pressing it right or left. Tilt is controlled by pressing the same button either up or down. The four small keypad buttons are used to engage presets. The larger keypad button is used to issue the SAVE command that saves the last selected preset.

Example 1: How to Create the Program

Use the Configuration Manager workspace in SIMPL Windows to select and configure all the devices that need to be included into the system. For Example #1, add a CNRFGWA to the system. The NET ID in this example is 24, which is the default ID for this device.

Set CNRFGWA NET ID in SIMPL Windows' Configuration Manager

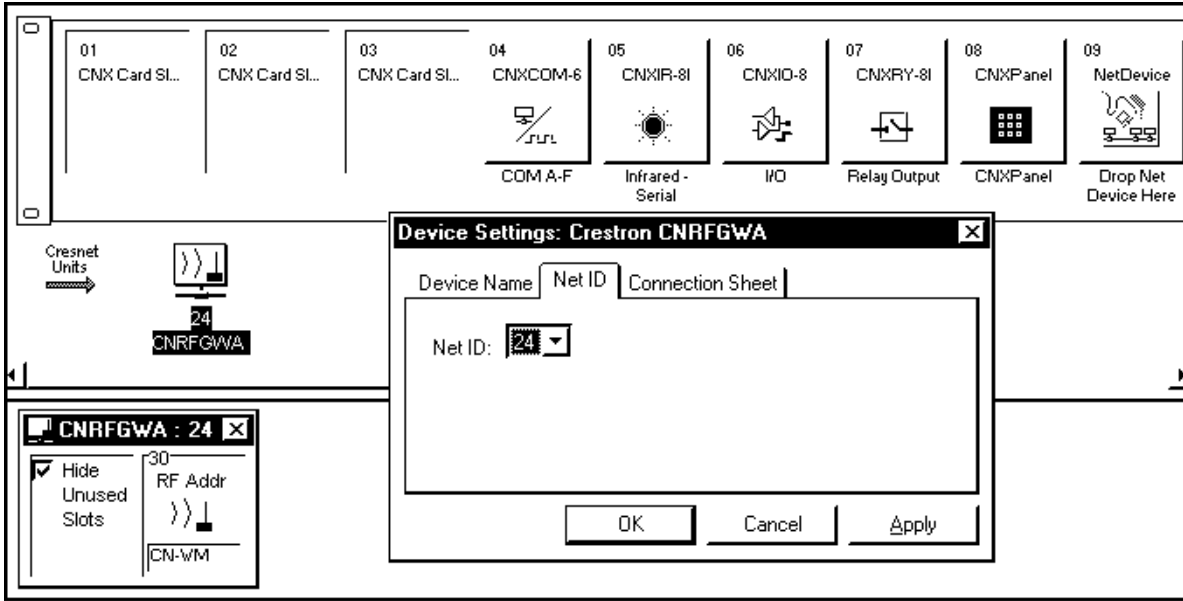

Add the CNMK to the program. Assign a NET ID of 28 as shown.

Assign CNWM NET ID

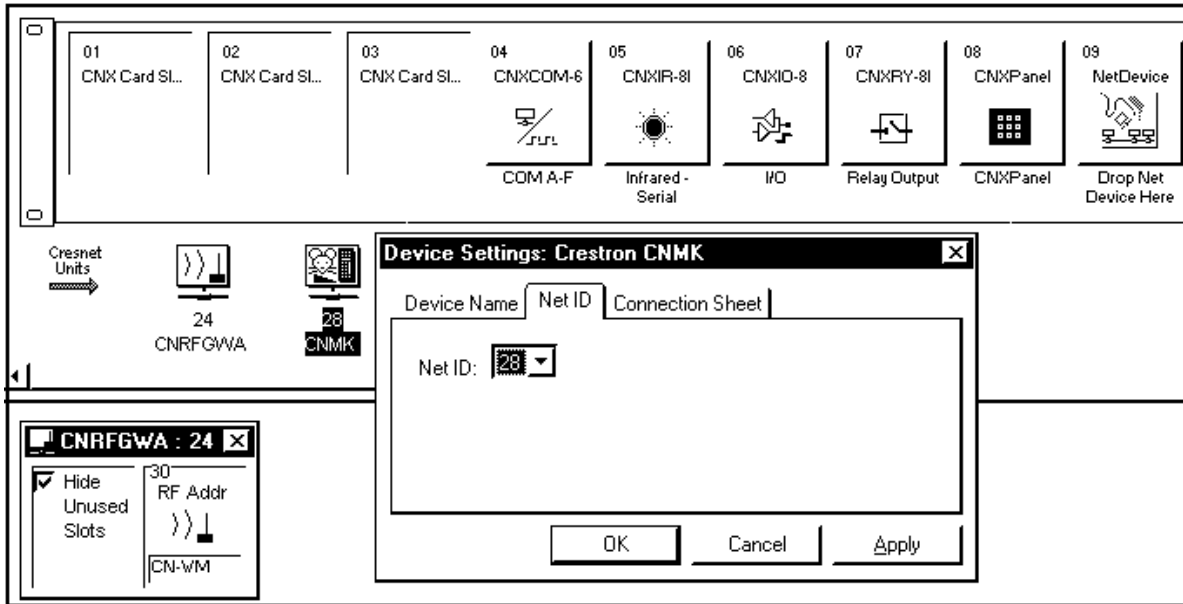

Use the Programming Manager workspace in SIMPL Windows to select symbols and assign their respective signals. For these examples, a CNRFGWA and CNMK symbols were added automatically when the devices were added to the system in the Configuration Manager workspace. Expand the Network Modules folder and double click on the CNRFGWA to expand it. Drag and drop the CNWM into Detail View. Assign signals as shown.

Graphical Detail View of the CNWM (Mouse) in SIMPL Windows' Programming Manager

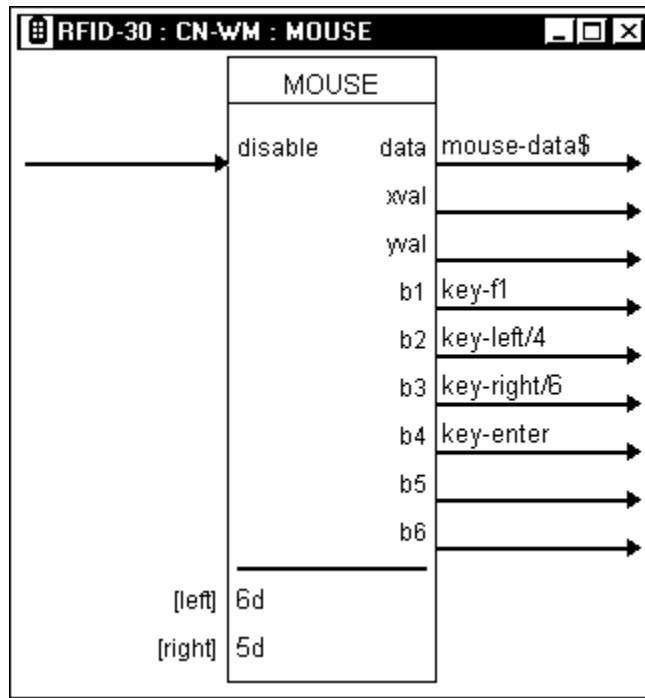

Double click on the CNMK () to display in Detail View (alternatively CTRL+D). Assign signals as shown.

Graphical Detail View of the CNMK (Mouse/Keyboard Wedge) in SIMPL Windows' Programming Manager

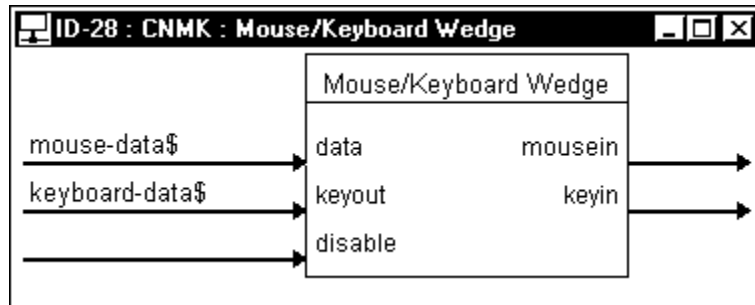

Add the SERIAL SEND symbols to this program by selecting them from the Symbol Library. View the symbol in Detail View (alternatively CTRL+D or drag and drop into Detail View). Assign signals as shown below.

Graphical Detail View of SERIAL SEND (signals S-1 through S-4) in SIMPL Windows' Programming Manager

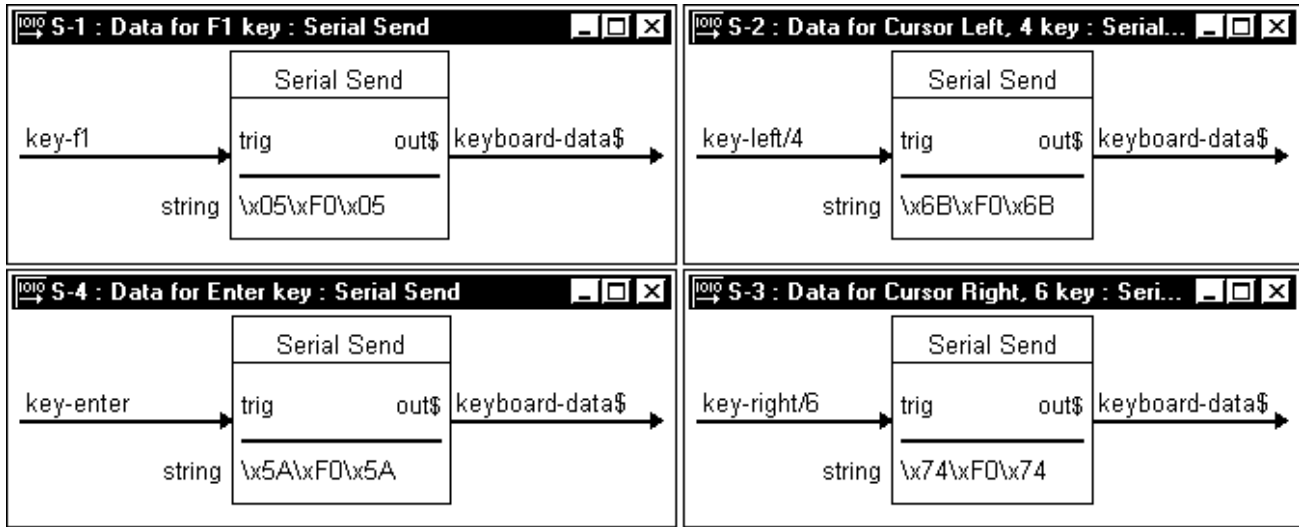

Example 2: How to Create the Program

Use the Configuration Manager workspace in SIMPL Windows to select and configure all the devices that need to be included into the system. For Example #2 add a CPC-CAMI to the system. For this example, the NET ID for this device is 03.

Set CPC-CAMI NET ID in SIMPL Windows' Configuration Manager

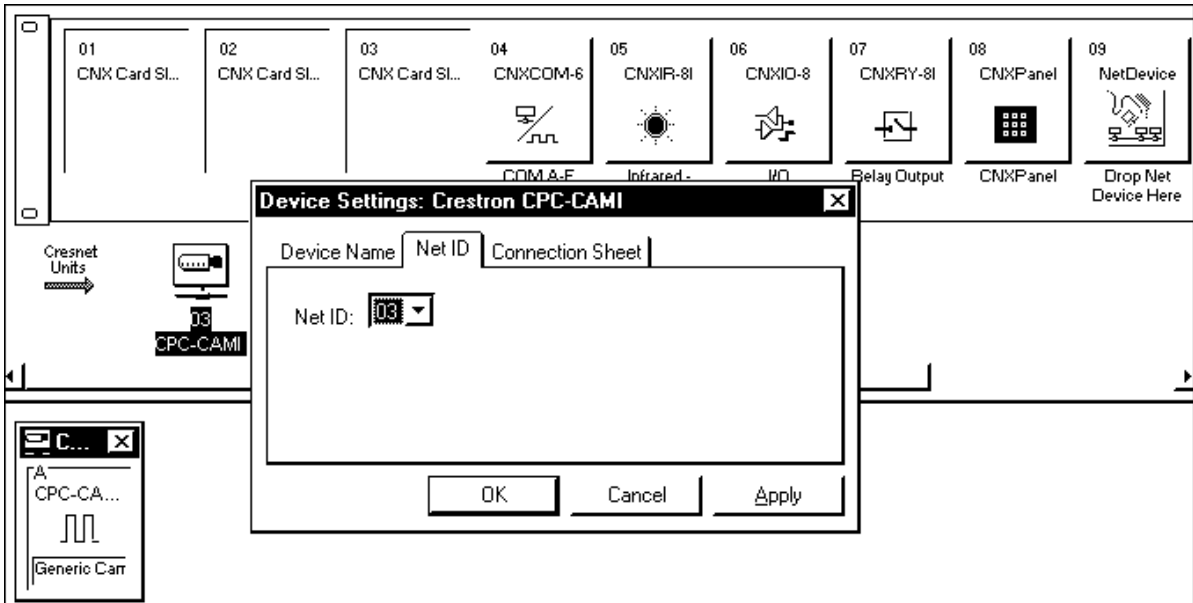

Add the CNRFGWA to the program. Assign a NET ID of 24 as shown. Add a CNWM (mouse) to RF ID 30 of the CNRFGWA.

Assign CNWM NET ID

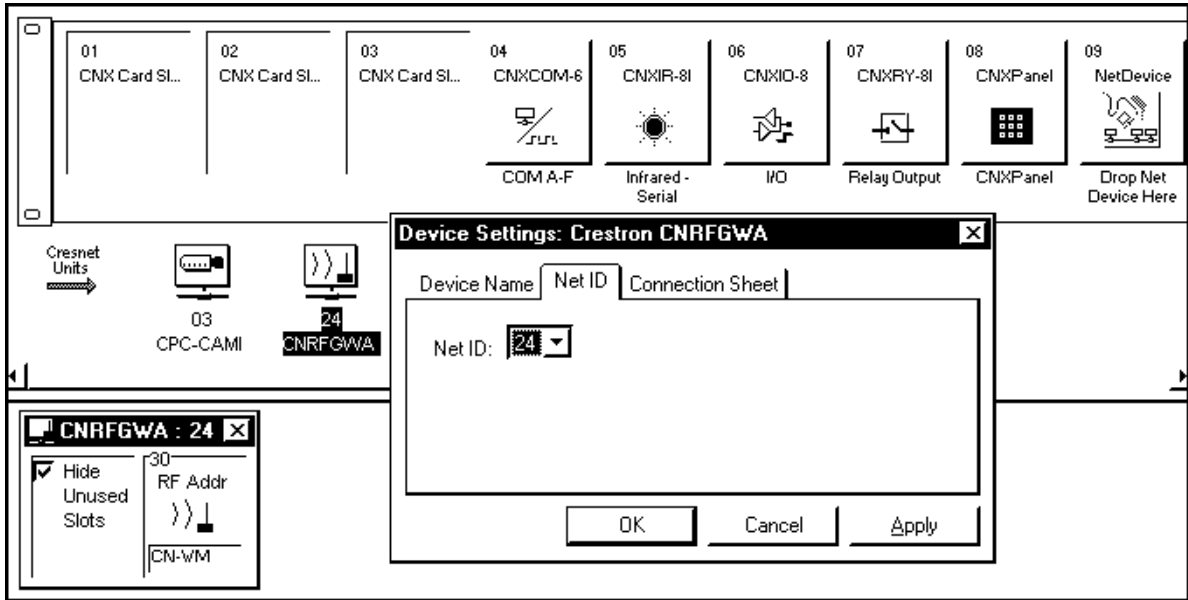

Use the Programming Manager workspace in SIMPL Windows to select symbols and assign their respective signals. For these examples, the CPC-CAMI, CNRFGWA, and CNMK symbols were added automatically when the devices were added to the system in the Configuration Manager workspace. Expand the Network Modules folder and double click on the CNRFGWA. Drag and drop the CNWM into Detail View. Assign signals as shown.

Graphical Detail View of the CNWM (Mouse) in SIMPL Windows' Programming Manager

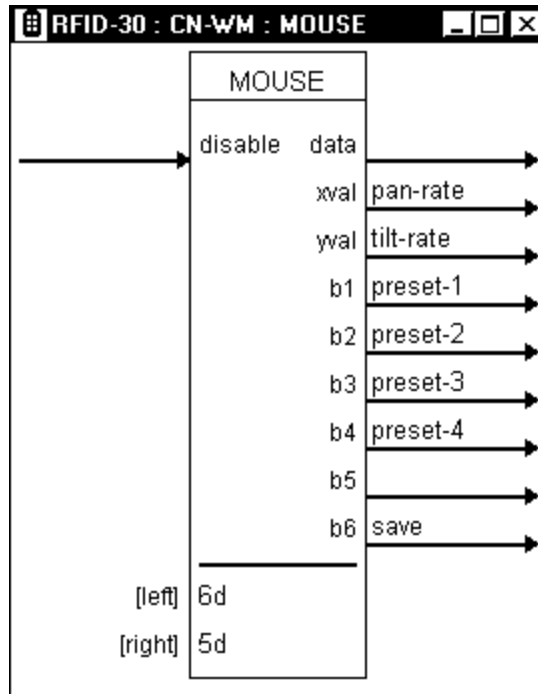

Double click on the CPC-CAMI to display it in Detail View (alternatively CTRL+D). Assign signals as shown.

Graphical Detail View of the CPC-CAMI in SIMPL Windows' Programming Manager

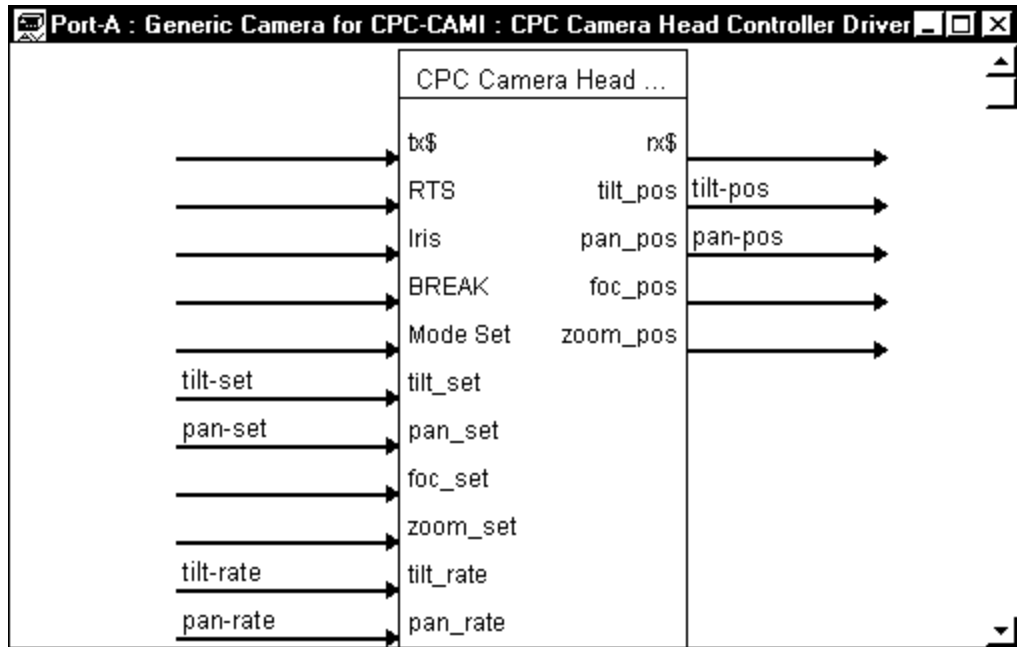

Add the NOR, INTERLOCK, and ANALOG RAM symbols to this program by selecting them from the Symbol Library. View the symbols in Detail View (alternatively CTRL+D or drag and drop into Detail View). Assign signals as shown below.

Graphical Detail View of ANALOG RAM, INTERLOCK, and NOR in SIMPL Windows' Programming Manager

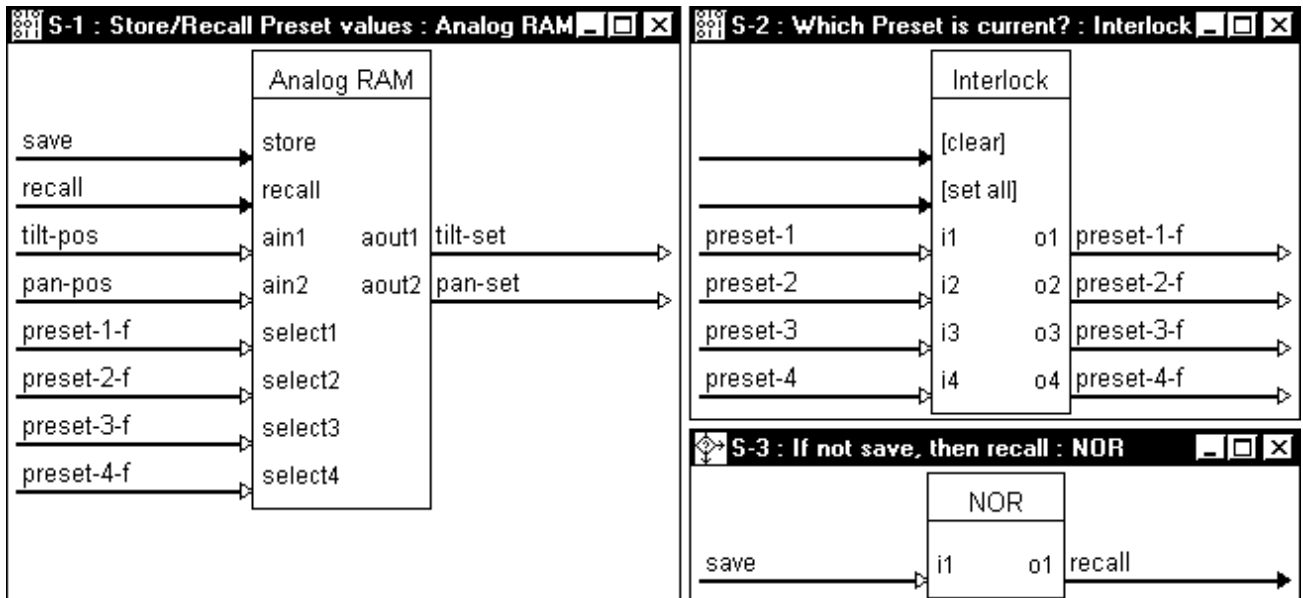

Accessing the Inlay Card

Each of the keypad buttons on the wireless mouse performs multiple functions. Rather than memorizing what each button does, write the functional descriptions on

the paper that surrounds the buttons. It is possible that the CNWM can be reprogrammed and thus the description labels on the Inlay Card beneath the plastic cover no longer apply. The SP-LK label kit can be used to create professional looking mouse inlay cards.

Remove Cover

Simply remove the clear plastic cover by inserting a flat lever such as a small flathead screwdriver into the opening above the largest keypad button. Apply a small amount of pressure with the flat lever to disengage the tongue and groove connections of the plastic cover with the rest of the unit. Write functional descriptions on the paper with a ball point pen or replace the existing sheet with one that has been printed with typed descriptions using the aforementioned .DXF file.

Fasten Cover

The first step to fasten the cover is to insert the curved-end tongue of the plastic cover into the appropriate groove of the unit. Lower the cover inserting the tongue from one side of the plastic cover into the appropriate groove of the unit. Slightly bend the plastic cover and simultaneously apply pressure down to insert the remaining tongue into place.

Problem Solving

Troubleshooting

The table below provides corrective action for possible trouble situations. If further assistance is required, please contact a CRESTRON technical support representative.

Wireless Mouse Troubleshooting

TROUBLE	POSSIBLE CAUSE(S)	CORRECTIVE ACTION
Intermittent response during transmission.	Batteries in unit are low or dead.	Install new batteries.
	Receiver is blocked or moved.	Verify that heavy metal is not in vicinity of transmission.
	Receiver is in vicinity of metal.	Verify that large amount of metal is not blocking transmission.
No response from system.	Refer to causes for intermittent response during transmission.	Refer to corrective actions for intermittent response during transmission.
	NET ID of receiver is incorrectly set.	Enter Performance Viewport from the STS/VTW software. Depress the F4 key to poll the network. Verify that the NET ID for the receiver is properly set to match the SIMPL WIndows program. NOTE: After changing the identity code, disconnect and reconnect the network connector.
	RF ID is incorrectly set.	Verify that the RF ID is properly set to match the SIMPL program. NOTE: NET ID and RF ID are separate parameters.
	Program does not match hardware.	Verify correct program is loaded in system via Performance Viewport.
	Receiver is unplugged (no power).	Verify power to the receiver.
	Two or more receivers are too close together.	Verify that multiple receivers are properly spaced (≥ 50 feet) from each other.
	Wrong transmitter in use.	If multiple transmitters are accessible, verify proper unit is used.

Further Inquiries

If you cannot locate specific information or have questions, please take advantage of Crestron's award winning customer service team by calling:

- In the US and Canada, call Crestron's corporate headquarters at 1-888-CRESTRON [1-888-273-7876] or 1-201-767-3400.
- In Europe, call Crestron International at +32-15-50-99-50.
- In Asia, call Crestron Asia at +852-2341-2016.
- In Latin America, call Crestron Latin America at +5255-5093-2160.
- In Australia, call Crestron Pacific at +613-9480-2999.

For local support from exclusive Crestron factory-trained personnel in New Zealand call Amber Technologies at +649-410-8382.

Return and Warranty Policies

Merchandise Returns / Repair Service

1. No merchandise may be returned for credit, exchange, or service without prior authorization from CRESTRON. To obtain warranty service for CRESTRON products, contact the factory and request an RMA (Return Merchandise Authorization) number. Enclose a note specifying the nature of the problem, name and phone number of contact person, RMA number, and return address.
2. Products may be returned for credit, exchange, or service with a CRESTRON Return Merchandise Authorization (RMA) number. Authorized returns must be shipped freight prepaid to CRESTRON, Cresskill, N.J., or its authorized subsidiaries, with RMA number clearly marked on the outside of all cartons. Shipments arriving freight collect or without an RMA number shall be subject to refusal. CRESTRON reserves the right in its sole and absolute discretion to charge a 15% restocking fee, plus shipping costs, on any products returned with an RMA.
3. Return freight charges following repair of items under warranty shall be paid by CRESTRON, shipping by standard ground carrier. In the event repairs are found to be non-warranty, return freight costs shall be paid by the purchaser.

CRESTRON Limited Warranty

CRESTRON ELECTRONICS, Inc. warrants its products to be free from manufacturing defects in materials and workmanship under normal use for a period of three (3) years from the date of purchase from CRESTRON, with the following exceptions: disk drives and any other moving or rotating mechanical parts, pan/tilt heads and power supplies are covered for a period of one (1) year; touchscreen display and overlay components are covered for 90 days; batteries and incandescent lamps are not covered.

This warranty extends to products purchased directly from CRESTRON or an authorized CRESTRON dealer. Purchasers should inquire of the dealer regarding the nature and extent of the dealer's warranty, if any.

CRESTRON shall not be liable to honor the terms of this warranty if the product has been used in any application other than that for which it was intended, or if it has been subjected to misuse, accidental damage, modification, or improper installation procedures. Furthermore, this warranty does not cover any product that has had the serial number altered, defaced, or removed.

This warranty shall be the sole and exclusive remedy to the original purchaser. In no event shall CRESTRON be liable for incidental or consequential damages of any kind (property or economic damages inclusive) arising from the sale or use of this equipment. CRESTRON is not liable for any claim made by a third party or made by the purchaser for a third party.

CRESTRON shall, at its option, repair or replace any product found defective, without charge for parts or labor. Repaired or replaced equipment and parts supplied under this warranty shall be covered only by the unexpired portion of the warranty.

Except as expressly set forth in this warranty, CRESTRON makes no other warranties, expressed or implied, nor authorizes any other party to offer any other party to offer any warranty, including any implied warranties of merchantability or fitness for a particular purpose. Any implied warranties that may be imposed by law are limited to the terms of this limited warranty. This warranty statement supercedes all previous warranties.

Trademark Information

All brand names, product names, and trademarks are the sole property of their respective owners. Windows is a registered trademark of Microsoft Corporation. Windows95/98/Me/XP and WindowsNT/2000 are trademarks of Microsoft Corporation.

AT Scan Code Table

FIND #	DESCRIPTION/ SYMBOL	"MAKE" SCAN CODE	"BREAK" SCAN CODE
1	~	\x0E	\xF0\x0E
2	1	\x16	\xF0\x16
3	2	\x1E	\xF0\x1E
4	3	\x26	\xF0\x26
5	4	\x25	\xF0\x25
6	5	\x2E	\xF0\x2E
7	6	\x36	\xF0\x36
8	7	\x3D	\xF0\x3D
9	8	\x3E	\xF0\x3E
10	9	\x46	\xF0\x46
11	0	\x45	\xF0\x45
12	-	\x4E	\xF0\x4E
13	=	\x55	\xF0\x55
15	Backspace	\x66	\xF0\x66
16	Tab	\x0D	\xF0\x0D
17	Q	\x15	\xF0\x15
18	W	\x1D	\xF0\x1D
19	E	\x24	\xF0\x24
20	R	\x2D	\xF0\x2D
21	T	\x2C	\xF0\x2C
22	Y	\x35	\xF0\x35
23	U	\x3C	\xF0\x3C
24	I	\x43	\xF0\x43
25	O	\x44	\xF0\x44
26	P	\x4D	\xF0\x4D
27	[\x54	\xF0\x54
28]	\x5B	\xF0\x5B
29	\	\x5D	\xF0\x5D
30	Cap Lock	\x58	\xF0\x58
31	A	\x1C	\xF0\x1C
32	S	\x1B	\xF0\x1B
33	D	\x23	\xF0\x23
34	F	\x2B	\xF0\x2B
35	G	\x34	\xF0\x34
36	H	\x33	\xF0\x33
37	J	\x3B	\xF0\x3B
38	K	\x42	\xF0\x42
39	L	\x4B	\xF0\x4B
40	;	\x4C	\xF0\x4C
41	'	\x52	\xF0\x52
43	Enter	\x5A	\xF0\x5A
44	Shift (left-most)	\x12	\xF0\x12
46	Z	\x1A	\xF0\x1A
47	X	\x22	\xF0\x22
48	C	\x21	\xF0\x21
49	V	\x2A	\xF0\x2A
50	B	\x32	\xF0\x32
51	N	\x31	\xF0\x31
52	M	\x3A	\xF0\x3A
53	,	\x41	\xF0\x41
54	.	\x49	\xF0\x49

FIND #	DESCRIPTION/ SYMBOL	"MAKE" SCAN CODE	"BREAK" SCAN CODE
55	/	\x4A	\xF0\x4A
57	Shift (right-most)	\x59	\xF0\x59
58	Ctrl (left-most)	\x14	\xF0\x14
60	Alt (left-most)	\x11	\xF0\x11
61	Space Bar	\x29	\xF0\x29
62	Alt (right-most)	\xE0\x11	\xE0\xF0\x11
64	CTRL (right-most)	\xE0\x14	\xE0\xF0\x14
75	Insert	\xE0\x70	\xE0\xF0\x70
76	Delete	\xE0\x71	\xE0\xF0\x71
79	Left Arrow	\xE0\x6B	\xE0\xF0\x6B
80	Home	\xE0\x6C	\xE0\xF0\x6C
81	End	\xE0\x69	\xE0\xF0\x69
83	Up Arrow	\xE0\x75	\xE0\xF0\x75
84	Down Arrow	\xE0\x72	\xE0\xF0\x72
85	Page Up	\xE0\x7D	\xE0\xF0\x7D
86	Page Down	\xE0\x7A	\xE0\xF0\x7A
89	Right Arrow	\xE0\x74	\xE0\xF0\x74
90	Num Lock	\x77	\xF0\x77
91	7 (Keypad)	\x6C	\xF0\x6C
92	4 (Keypad)	\x6B	\xF0\x6B
93	1 (Keypad)	\x69	\xF0\x69
95	/ (Keypad)	\xE0\x4A	\xE0\xF0\x4A
96	8 (Keypad)	\x75	\xF0\x75
97	5 (Keypad)	\x73	\xF0\x73
98	2 (Keypad)	\x72	\xF0\x72
99	0 (Keypad)	\x70	\xF0\x70
100	* (Keypad)	\x7C	\xF0\x7C
101	9 (Keypad)	\x7D	\xF0\x7D
102	6 (Keypad)	\x74	\xF0\x74
103	3 (Keypad)	\x7A	\xF0\x7A
104	. (Keypad)	\x71	\xF0\x71
105	- (Keypad)	\x7B	\xF0\x7B
106	+ (Keypad)	\x79	\xF0\x79
108	Enter (Keypad)	\xE0\x5A	\xE0\xF0\x5A
110	Esc	\x76	\xF0\x76
112	F1	\x05	\xF0\x05
113	F2	\x06	\xF0\x06
114	F3	\x04	\xF0\x04
115	F4	\x0C	\xF0\x0C
116	F5	\x03	\xF0\x03
117	F6	\x0B	\xF0\x0B
118	F7	\x83	\xF0\x83
119	F8	\x0A	\xF0\x0A
120	F9	\x01	\xF0\x01
121	F10	\x09	\xF0\x09
122	F11	\x78	\xF0\x78
123	F12	\x07	\xF0\x07
124	Print Screen	\xE0\x12\xE0\x7C	\xE0\xF0\x7C\xE0\xF0\x12
125	Scroll Lock	\x7E	\xF0\x7E
126	Pause	\xE1\x14\x77\xE1	\xF0\x14\xF0\x77

This page intentionally left blank.

This page intentionally left blank.

This page intentionally left blank.



Crestron Electronics, Inc.
15 Volvo Drive Rockleigh, NJ 07647
Tel: 888.CRESTRON / 201.767.3400
Fax: 201.767.7576 / BBS: 201.767.5506
www.crestron.com

*Specifications
subject to change
without notice.*

Doc. 5700A
01.99

